



Power and Performance for the Automotive Industry



Tsubaki Group Products and Network

Tsubaki Global Network

The Tsubaki Group's extensive network of production and sales bases supports our customers' businesses in real time around Japan and around the world.

(As of March 2013)

- Japanese manufacturing base
- Tsubaki Group manufacturing and sales company
- Tsubaki Group sales company

Japan - Factories



Kyotanabe Plant



Saitama Plant



Kyoto Plant



Hyogo Plant



Tsubaki E&M Co. Okayama Plant



Tsubakimoto Mayfran Inc.



North & South America (12 companies)



U.S.Tsubaki Holdings, Inc.



Tsubaki of Canada Limited

Europe (17 companies)



Tsubakimoto Europe B.V.



Tsubaki Kabelschlepp GmbH



Tsubakimoto U.K. Ltd



Mayfran Limburg B.V.

Asia & Oceania (29 companies)



Taiwan Tsubakimoto Co.



Tsubakimoto Automotive (Shanghai) Co., Ltd



Tsubakimoto Chain (Tianjin) Co., Ltd.
Full-scale production planned from December 2012.



Tsubaki E&M (Shanghai) Co., Ltd.



Tsubakimoto Singapore Pte Ltd



Tsubaki Australia Pty Ltd

You'll find many Tsubaki products bei

There are many processes that go into making a motor vehicle. You'll find Tsubaki products in all of these processes, from conveying vehicle bodies from the stockyard, components from the formation presses, and assembled bodies from the welding process to the coating process, to the mounting and assembly processes for the interior, engine, transmission, and other components, and finally to engine output, brakes, and shower testing lines.

1

Press Section

Cutting, casting, forging, sheet metal presses, plastic molding, etc.

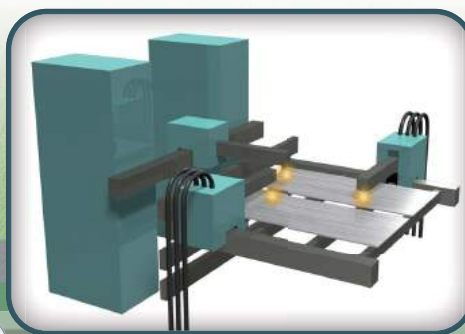

Tsubaki's scrap conveyors are used in the press section



5

Inspection Section

Engine output, brakes, shower tester, visual inspection



4

Assembly

Mounting of interior (engine, suspension, seats, electrical components), tires, fenders, side



Tsubaki Timing Chain is used by global automotive manufacturers.

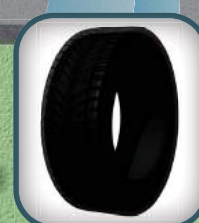

Many Tsubaki products are used in manufacturing tires as well.

ng used in automotive manufacturing

2

Body Welding Section

Welding and assembly of roofs and body panels



3

Coating Section

Coating of bodies, doors, and other components



Section

components (transmission, dashboard, components) and exterior components (view mirrors, etc.)

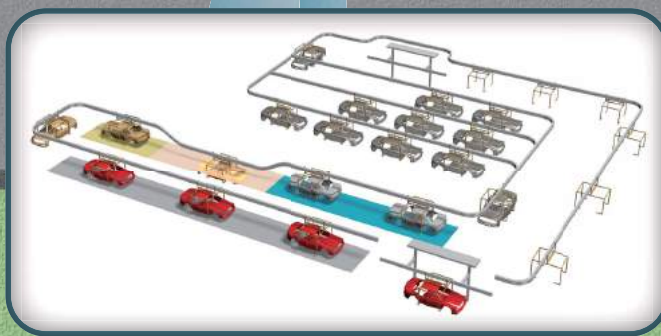

Tsubaki floor and overhead conveyors are used in every section.

1 Press Section

Roofs, hoods, and other major body components are formed on 5,000 ton presses. Many precision components are formed on servo presses, and these servo presses use Tsubaki's HY Series Ultra PX ultra-high strength timing belts.

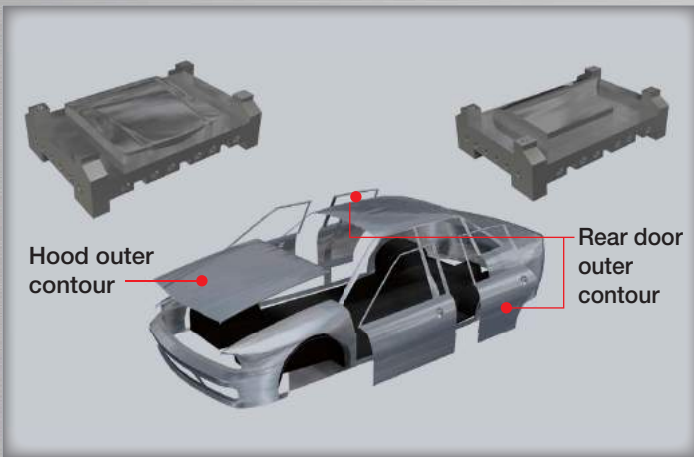

HY Series Ultra PX Timing Belt

HY Series is ultra-high strength,
with 1.3 – 2.0 times the transmission performance of HC Series!

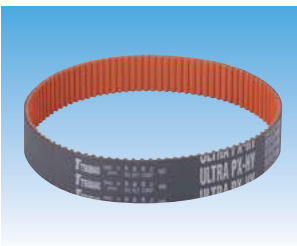

Servo presses need highly durable, high strength belts that can handle frequent shock loads under continuous operation, so they use HY Series Ultra PX ultra-high strength timing belts (with double the durability and strength of HC Series). This allows users to reduce the size of their equipment for more compact operation.

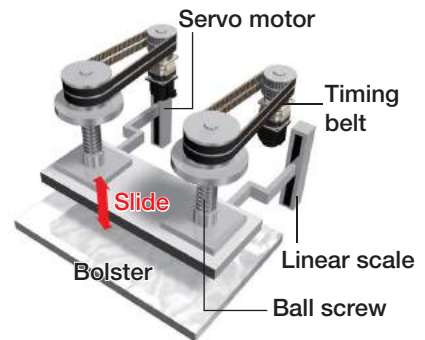

Ultra-high Strength

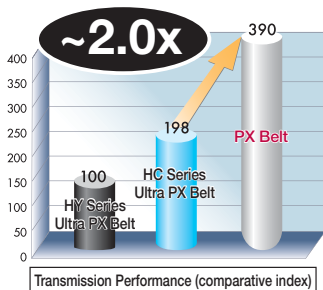

Ultra-high Durability

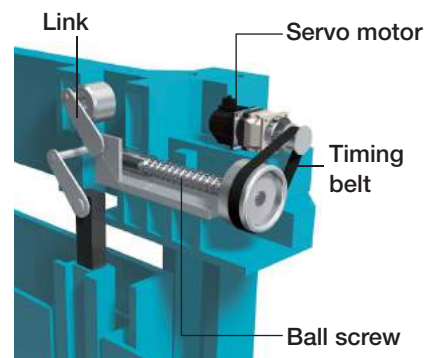
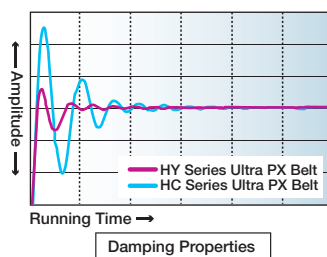

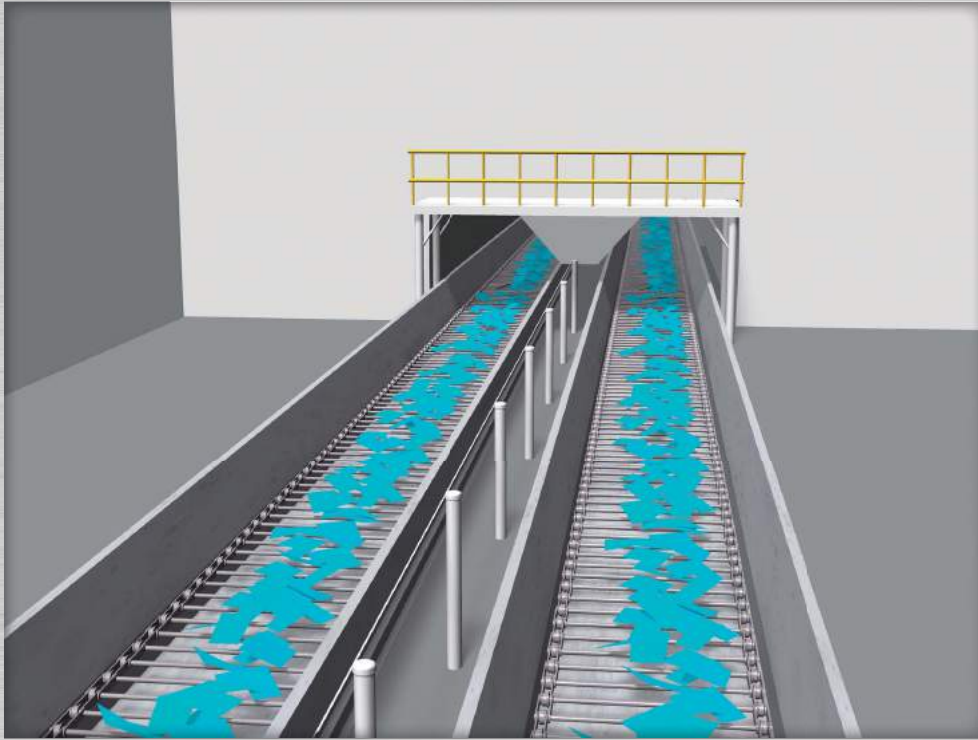

Large Size Conveyor Chain

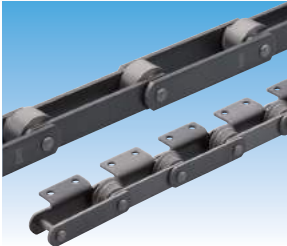

Several scrap conveyors operate beneath the floor of the press section, on to which scrap material is discharged. These scrap conveyors feature Tsubaki large size conveyor chains with slats attached to convey press scrap to outside the facility.



Tsubakimoto Mayfran Scrap Conveyor

Small Gear Motor

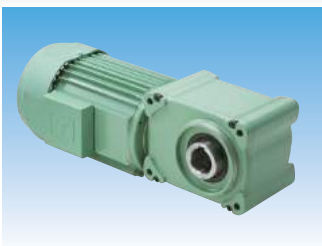

The small gear motors that drive the scrap conveyors that discharge mill ends use Tsubaki hypoid motors. The output shaft features both a solid and hollow shaft with a wide range of reduction ratios available.

2 Body Welding Section

In the welding section, pressed components are automatically welded onto vehicle bodies using multi-axis robots. Tsubaki plastic Cableveyors guide and protect the welding gas hoses as well as power and signal cables on these robots.



Plastic Cableveyor



Tsubaki plastic Cableveyors come in an extensive array of sizes and shapes and are used to guide and protect cables and hoses in multi-axis robots and other specialized equipment. They use flame resistant certified material for peace-of-mind use in areas that require inflammability.



HC Series Ultra PX Timing Belt



The guns that move welding electrodes need to provide high strength, compact power transmission while having a clean transmission mechanism that will not spatter grease and oil. They use Tsubaki HC Series Ultra PX timing belts

High Precision High Strength

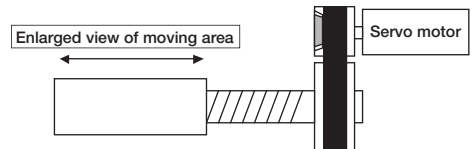
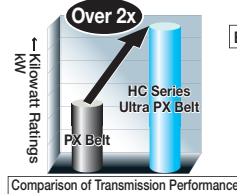
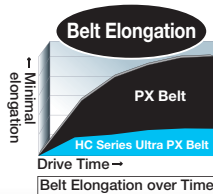

PAT-B Series Precision Planetary Gear Reducer for Servo Motors

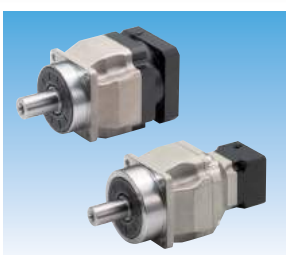

The guns that move welding electrodes need to provide high strength, compact power transmission. The PAT-B Series with its high durability and low backlash is used on the welding robot jigs.

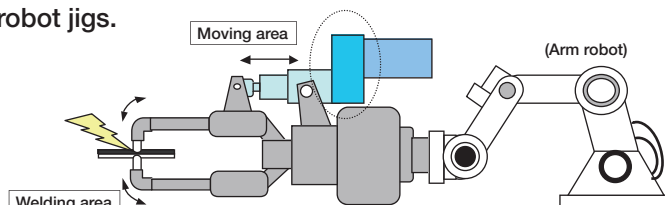

3 Coating Section

Primer Coat

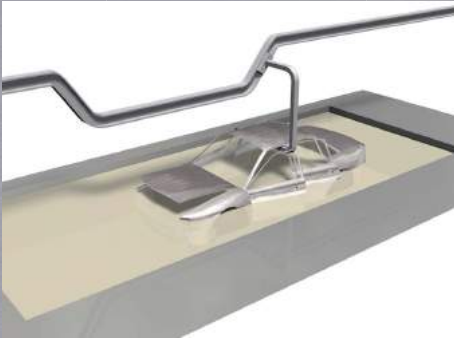

The vehicle body primer coat is electrodeposited for rust resistance, so the body is hung from the ceiling and conveyed submerged through a pool of coating. After the intermediate coat, each body is set on a cart and driven by friction rollers, which use Tsubaki's small gear motor gear reducers.

Small Gear Motor



Intermediate Coat



The intermediate coat makes the vehicle body surface smooth and prevents fading. This gray coat is sprayed all over the body using a coating robot. These multi-axis robots use Tsubaki plastic Cableveyors to support and guide their power cables.



TKRB Series Plastic Cableveyor



Top Coat



The top coat is the actual car color sprayed on by coating robots and reciprocating coating machines. It gives the body an even, beautiful finish. The reciprocating coating machines use Tsubaki drive chains and reducers.

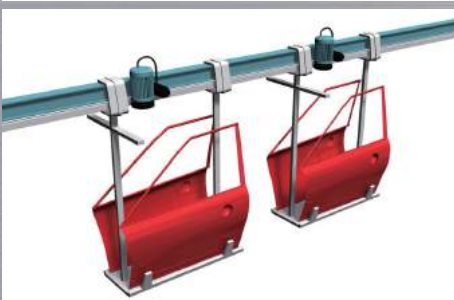

Lube-free Tsubaki Lambda Chain

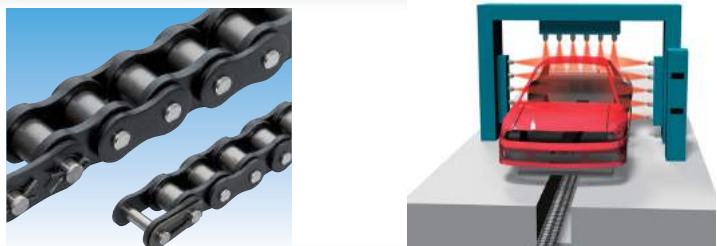

4 Assembly Section

Doors, interior components, seats, and tires are attached to the coated vehicle body in the assembly section. The bodies are conveyed on slat conveyors, conveyed by special suspension fixtures from the ceiling, or conveyed by carts driven by friction rollers with the assembly workers also riding on top. The components are all attached where designated.

Components to be attached travel along separate conveying routes alongside the vehicle bodies, where they are attached by workers.

Bearing Roller Conveyor Chain



Tsubaki Bearing Roller Conveyor Chain features cylindrical bearings embedded in the rollers to minimize roller rolling resistance and save power over long conveying distances. It also prevents stick slipping from occurring at low speeds.



Small Size Gear Motor

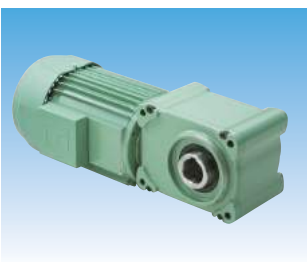

Tsubaki's expansive line-up of small size gear motors all use international standards.

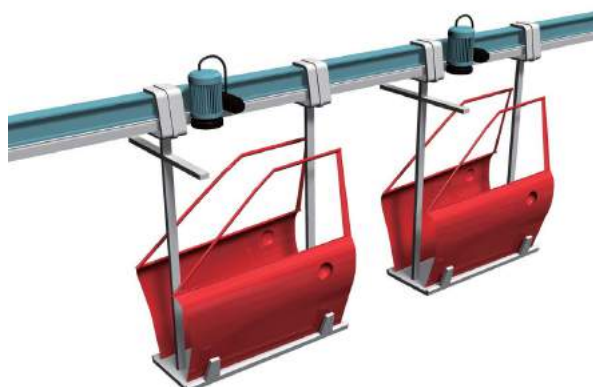

Liftmaster®

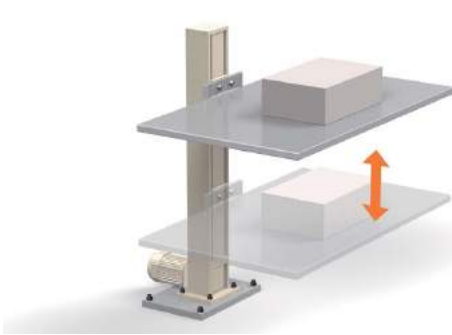

Used to transfer assembled heavy components (engines, transmissions, suspensions) and vehicle bodies to the next process, the Tsubaki Liftmaster is a lifter with a screw-type support beam and internal guide. These lifters can be installed simply with just bolts, with no need to dig pits.



Zip Chain Lifter®



The Zip Chain Lifter is a high speed lifting device that can lift body vehicle components for attachment and stop them at the eye level of assembly workers with unparalleled precision. This increases work efficiency and productivity by improving working posture, and increases ease of maintenance as well.



Power Cylinder



Power cylinders are used to open and close the suspension tongs. There is a risk of leaking oil getting on the vehicles with hydro-pneumatic cylinders and hydraulics for handling the pipes that go to the suspension tongs, so electric power cylinders are being increasingly used.

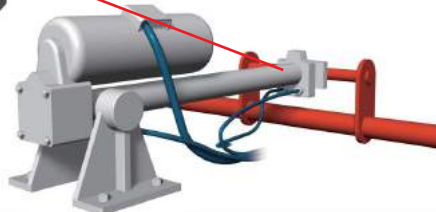

4 Assembly Section (Component Conveyance)

RS® Attachment Chain

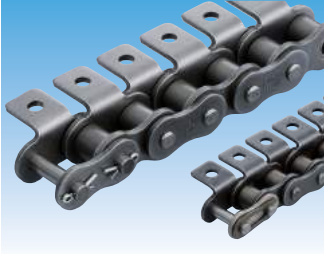

Application: Tire conveyors

These chains are often used on short conveyors (normally less than 10m long) to convey small parts at small pitches. These chains are ideal for reducing noise and creating friendly work environments.



Application: Tire conveyor before body assembly

Small size conveyor chain with dogs convey to fixed positions



Conveyor lifting one tire at a time from the upper conveyor



Double Pitch® Chain



Application: Secondary battery conveyor

This conveyor chain features flat plates with attachments and double the pitch of standard ANSI roller chain. It has high total length precision, and depending on the application it can accommodate R or S rollers.

Battery aging line

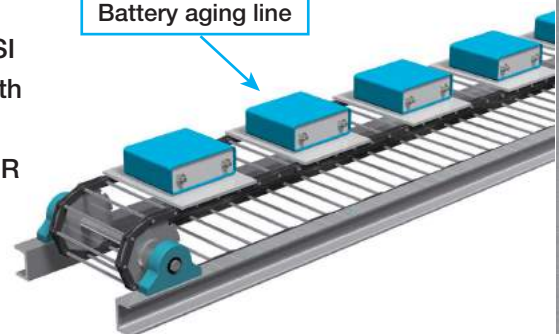

Double Plus Chain

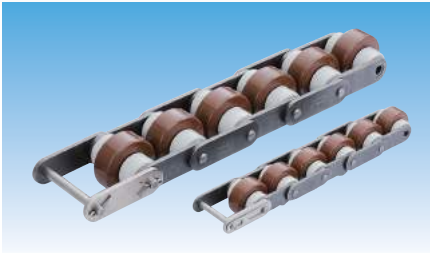

Application: Seat conveyor

Combining both small and large rollers, this unique chain enables 2.5x high speed conveyance. Chain speed can be kept low, which allows for quiet accumulation. Snap covers can also be attached to prevent parts from falling into the frame.

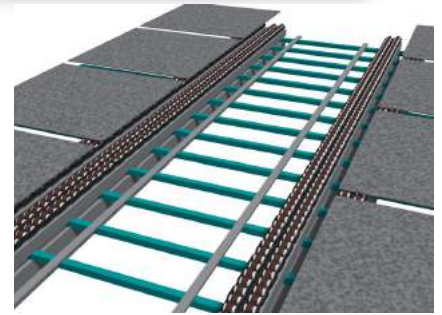

Lube Free Small Size Conveyor Chain (Lambda Small Size Conveyor Chain)

This chain uses special oil impregnated bushes and is available in most small size conveyor chain models. This lube-free roller chain has received high praise for its performance since its launch in 1988.

- Lube-free, long life operation: Special oil impregnated sintered bushes give this chain long life.
- Interchangeable: Interchangeable with standard small size conveyor chain.
- Operating temperature range: -10°C to 150°C (KF Series can be used up to 230°C)
- Has greatly longer wear life compared to standard small size conveyor chain.

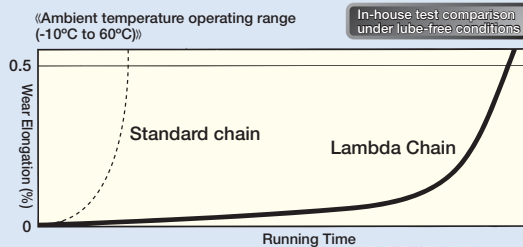

Basic Construction

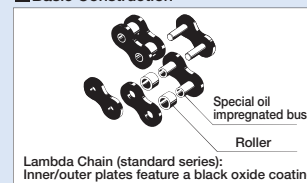

Application:
Mounting bolt conveyor

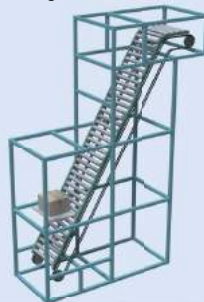

Application: Die conveyor

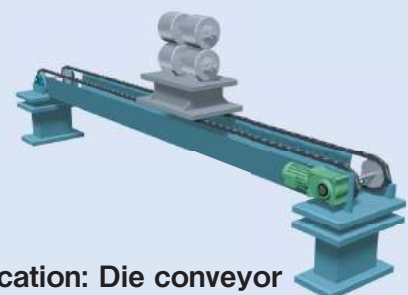

Plastic Cableveyor®



Application: Interior assembly conveyor

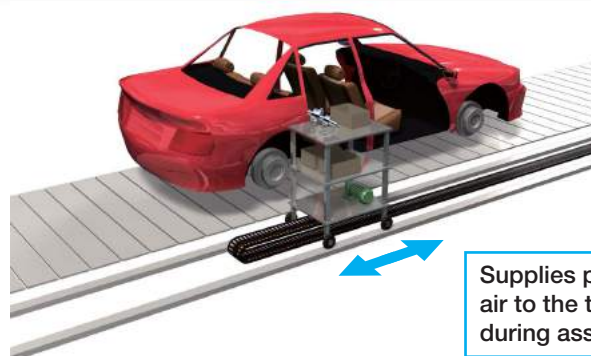

5 Inspection Section

After the vehicle is assembled, engine output, brakes, and headlight optical axis are tested, the body is inspected, and the car is subjected to high pressure water to check for leaks.

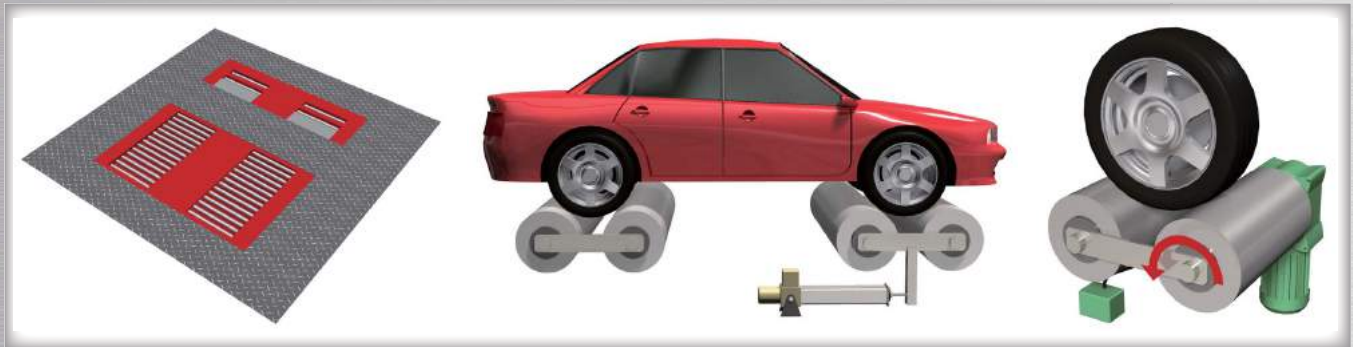

Power cylinders are used to check roller pressurization and front and back axle positioning in engine and brake tests, and reducers with Cam Clutches are used to drive the rollers.

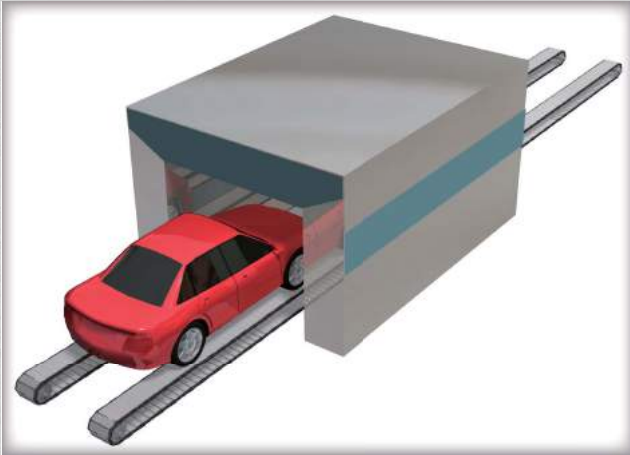

Lube Free Bearing Roller Conveyor Chain Water Resistant Series

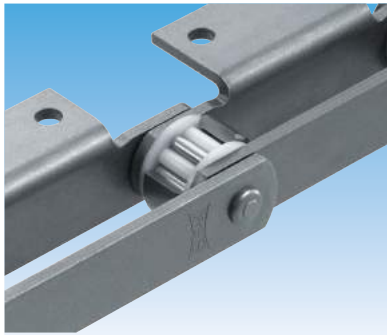

After the engine, brakes, and optical axis of the headlights are inspected, the vehicle is then brought into a booth (shower tester) where it will be subjected to a high pressure water spray to check for leaks. The vehicle is set on a conveyor chain on a long conveyor and conveyed through the shower tester at low speeds. There is a high probability of stick-slipping occurring on long conveyors at low speeds, and this is where Tsubaki Bearing Roller Conveyor Chain demonstrates its features. This chain uses a unique design with cylindrical bearings embedded in the rollers to suppress stick-slipping, and provides higher efficiency, lower costs, and longer roller/rail life. A lube-free water resistant series is available as well.

■ Construction

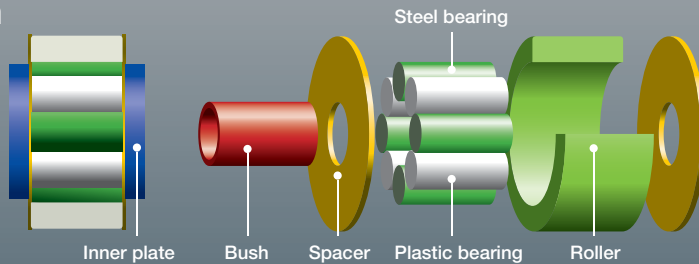

Dual-sided conveyor

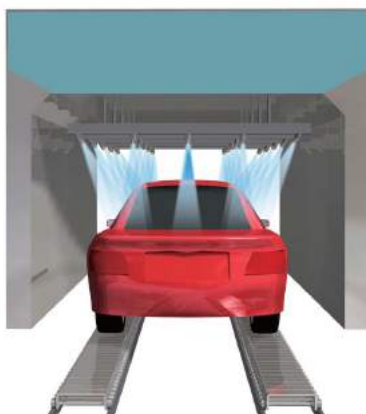

Single-sided conveyor

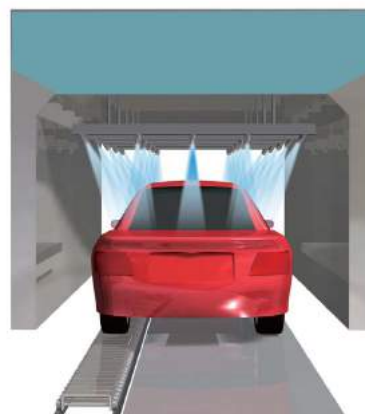



Engine and Reducer Component Assembly

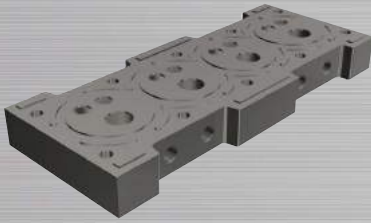

Cylinder head

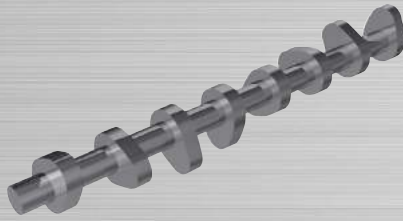

Cam shaft



Connecting rod

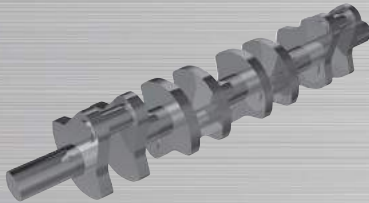

Crank shaft

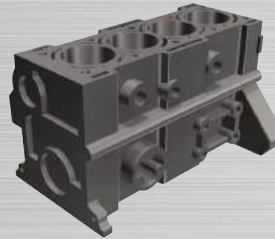

Cylinder block

Top Roller Chain

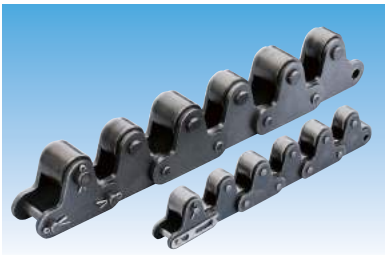

Top Roller Chain is a free flow chain that features a taller plate on either double pitch or RS roller chain to accommodate freely rotating top rollers. With hardened chrome plating and buffing available for the top rollers, you can select the right chain for your work or working environment.

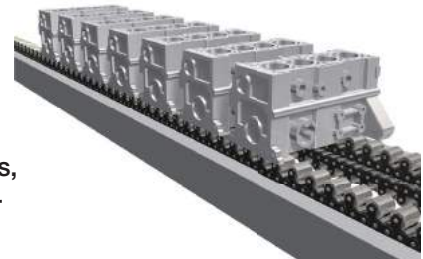

TS Series Stainless Steel Top Chain

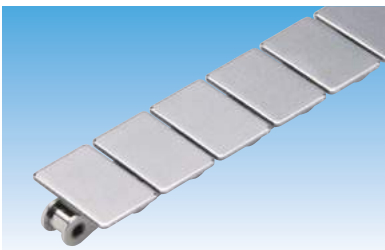

This conveyor chain features plates on top of a double pitch chain. The plates are tempered to increase their wear resistance, and with hardened chrome plating and buffing available for the top rollers, you can select the right chain for your work or working environment.

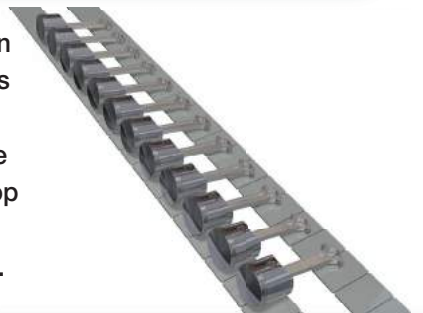

TO Series Stainless Steel Top Chain

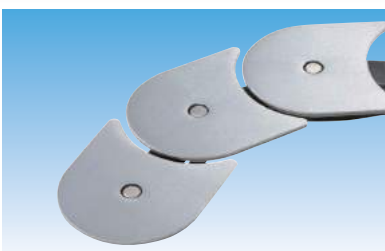

Used for lateral conveyance, it can be used effectively on return sections.



Double Plus Chain

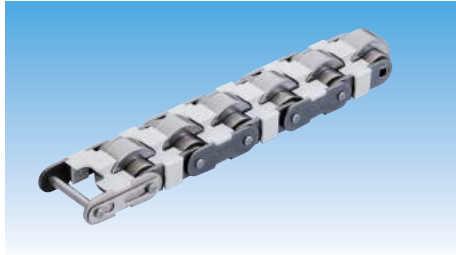

Combining both small and large rollers, this unique chain enables 2.5x high speed conveyance. Chain speed can be kept low, which allows for quiet accumulation. Snap covers can also be attached to prevent parts from falling into the frame.



Outboard Roller Chain

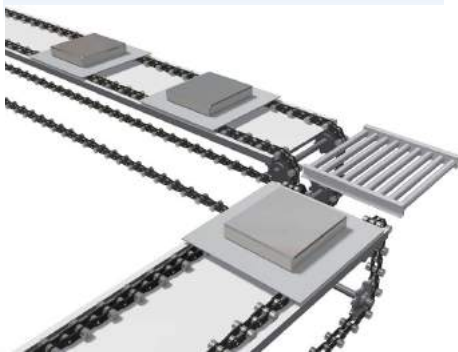

Outboard roller chains are free flow chains that feature extended pins on double pitch or RS roller chains to attach freely rotating outboard rollers.

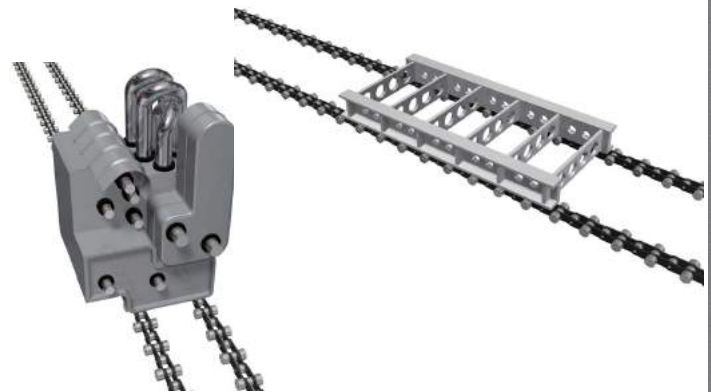

Reducers for Conveyor Drives

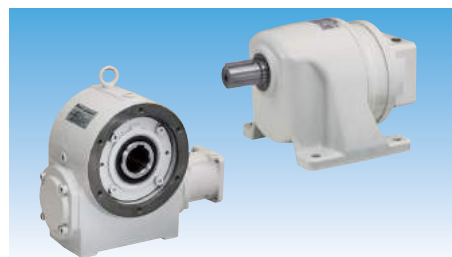
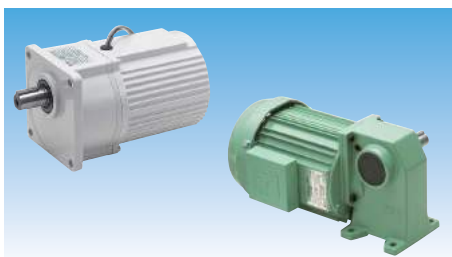

7 Related Equipment

Car washers – Reducers for moving the gates and lifting/rotating the brushes

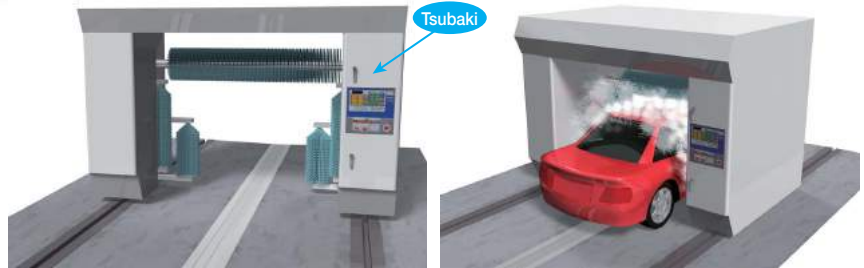

The optimal reducer attached to a motor is used to move the gate itself and rotate and lift the brushes used to clean the car.

Power cylinders for tire mounters that attach the tires to the wheels



Power cylinders, which have highly precise positioning and require no adjustment, are used for setting the side of the tire to where the tire and wheel will be attached. They are also used in lifting equipment.

Power cylinders and Zip Chain Actuators for lifting component cart racks

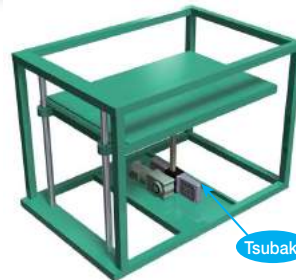

Zip Chain Actuators and power cylinders are used in positioning equipment that lifts component racks to worker waist levels to increase assembly productivity.

SAFCON overload and protection devices on safety equipment for ETC gate lifting arms

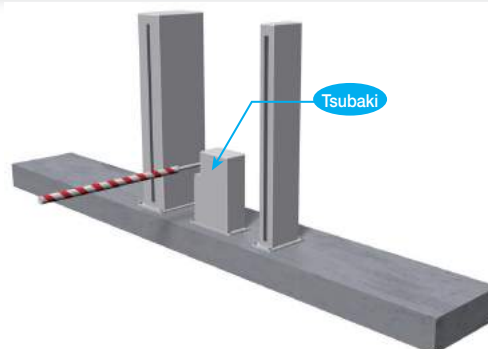

SAFCON overload and protection devices are used to prevent gate arm malfunctions that cause the arm to not open properly and possibly cause damage to vehicles.

SAFCON Shock Monitors on load monitoring devices for various component conveyors

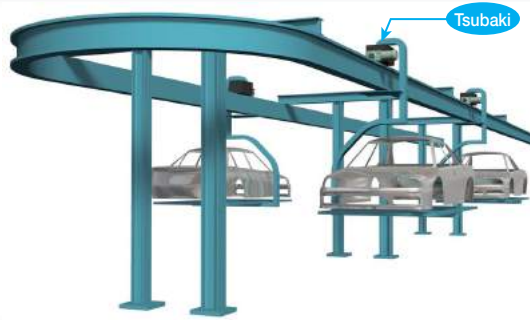

Electrical load type Shock Monitors monitor drive motor input power to detect slight variations in load and prevent damage to conveyed goods and equipment.

Plastic Cableveyors for gantry loader running axles

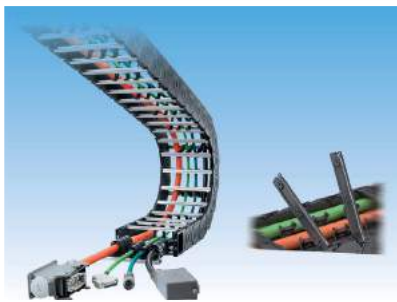

Cableveyors are used on support and guiding equipment for gantry loaders, which convey components at high speeds.

Application Example

Plastic Modular Chain for Conveying

Before

Standard belt conveyor



Switched to modular chain

After

Modular chain

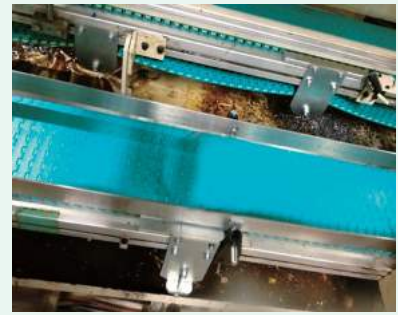

Belt rupture



Stick-slip

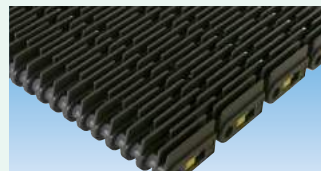
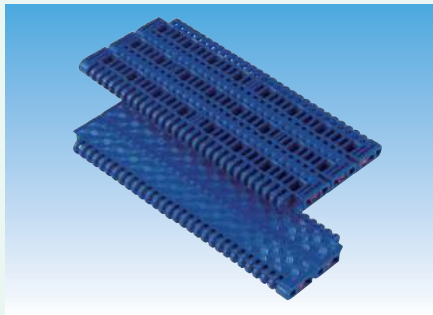

Due to the oil that adheres to conveyed goods, belt conveyors suffer the following shortcomings:

1. Stick-slipping of the belt means unstable conveyance.
2. Swelling causes the belt to stretch and suffer shorter life.
3. Belts can suddenly rupture.

But with modular chain:

1. Sprocket drives make stable conveyance possible.
2. Chains suffer little elongation, giving them long life.
3. The chains can be replaced in sections.
4. Enables thin conveyance, just like with belts.

Tsubaki group website

Tsubaki Power Transmission Products

Technical Information Website

TT-net now online

TT-net, Tsubaki Power Transmission Products*1 Technical Information Website within the Tsubaki group website, has been online since April 8, 2013.

*1 Power transmission products are machine parts for general industrial use such as chains, reducers, and linear actuators.



■ TT-net
<http://tt-net.tsubakimoto.co.jp>

■ Tsubaki website
<http://tsubakimoto.com>



TSUBAKIMOTO CHAIN CO.

Headquarters

Nakanoshima Mitsui Building
3-3-3 Nakanoshima, Kita-ku
Osaka 530-0005, Japan
Phone : +81-6-6441-0011
Facsimile : +81-6-6441-0489
Internet:
<http://tsubakimoto.com/>

Chain Division

Chain Sales Department
1-3 Kannabidai 1-chome
Kyotanabe, Kyoto 610-0380, Japan
Phone : +81-774-64-5023/4
Facsimile : +81-774-64-5212

For further information please
contact the Chain Division.