

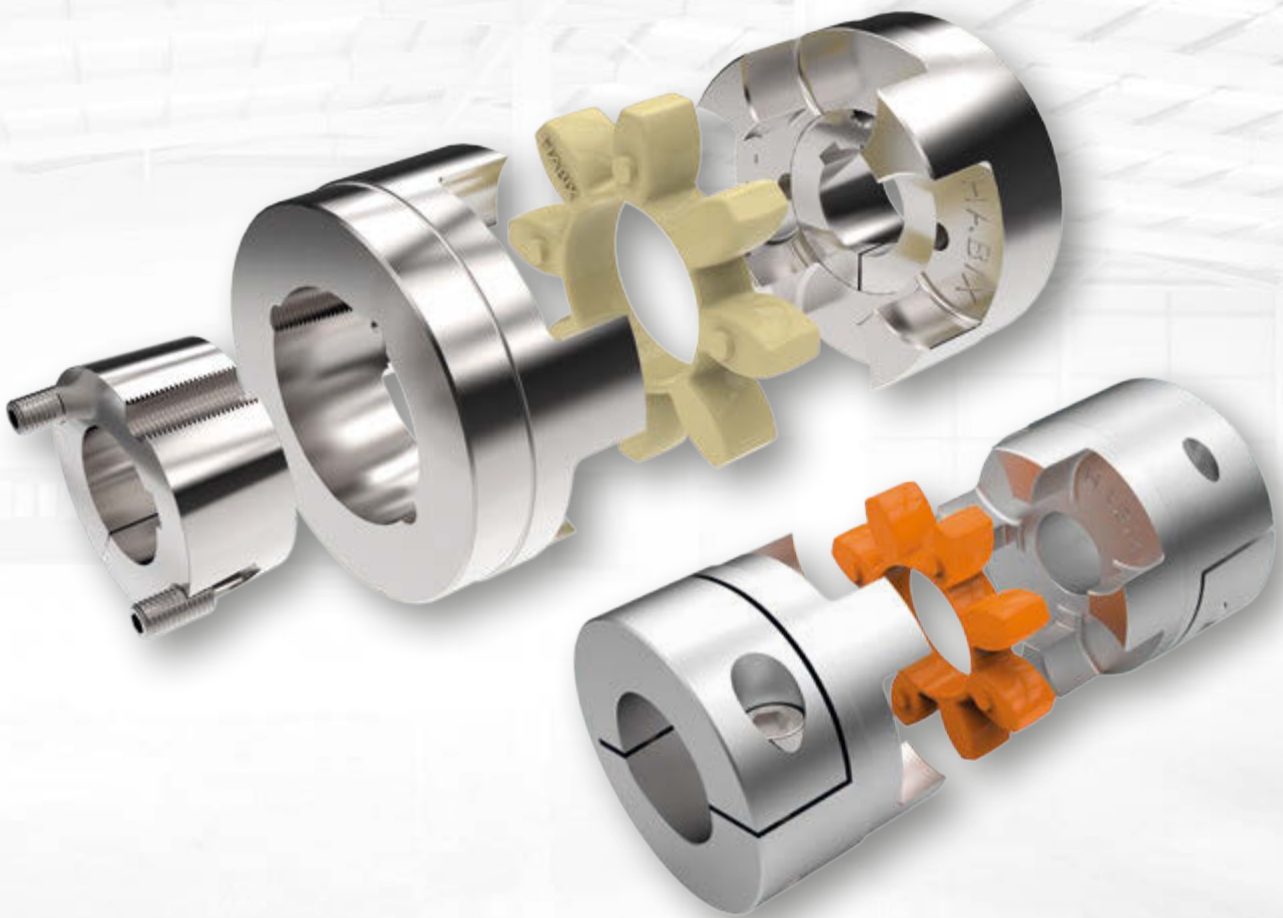

**POWER TRANSMISSION
FLEXIBLE COUPLINGS**

HABIX® HWN / HWT HABIX® PLUS HPN / HPK



HABIX®

TYPE HWN

The flexible Habix® coupling, type HWN, is a distortion-free jaw coupling with flexible elements for the torsionally flexible connection of shafts. The advantage of the all-round-machined Habix® couplings is the precision of the operating characteristic as well as the increased durability. Habix® couplings are distortion-free up to the breaking load of the cast iron transmission cam and insure a maximum of operational safety. The flexible element is available in white color with a hardness of 92 Shore A and in red color with a hardness of 98 Shore A. It is resistant against wear as well as against oil, ozone and ageing. The flexibility of the couplings absorbs efficiently shockloads, torsional vibrations and noises. The flexible element of the couplings has been designed to compensate radial, axial and angular movements between the coupling halves. By the fixed position of the flexible element its deformability in axial direction is free and no harmful axial forces may disturb the machine bearing even with changing torques. The flexible element of the Habix® coupling allows a permanent thermal load up to 80 °C. Even low temperatures up to -20 °C are allowed. The flexible Habix® coupling can easily be connected and does not require a high accuracy of the shaft alignment.

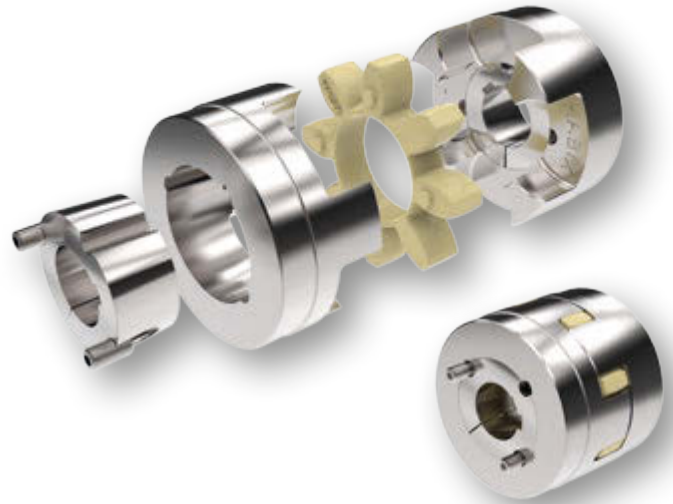

TYPE

- > Standard coupling HWN
- > Taper bush type HWT
- > Combined type standard/taper HWNT
- > Components can be combined as needed

TYPE HWT – WITH TAPER BUSH

The Habix® coupling type HWT joins the advantages of the flexible couplings with the advantages of the taper bush system: fast and easy installation for a torsionally flexible connection between shafts and compensation of shaft misalignments. The HWT types with the taper bush system have the advantage that there is a backlash-free and at the same time axial

fixing of the shaft even at bigger shaft tolerances. In addition the slide fit allows the axial alignment of the coupling. The exchange of the flexible element is possible by simply sliding the coupling halves in axial direction without removing the driving or driven machine. The field of application of the Habix® coupling is all the engineering industry wherever a safe connection between motor and driven machine is required.

TECHNICAL DATA

TYPE HWN/HWT

Size	Max. rotation speed rpm	Torque Nm			Torque Nm		
		nominal T_{KN}	max. T_{kmax}	changing T_{KW}	nominal T_{KN}	max. T_{kmax}	changing T_{KW}
		92° Shore A color white			98° Shore A color red		
19	19000	10	20	2.6	17	34	4.4
24	14000	35	70	9	60	120	16
28	11800	95	190	25	160	320	42
38	9500	190	380	49	325	650	85
42	8000	265	530	69	450	900	117
48	7100	310	620	81	525	1050	137
55	6300	410	820	105	685	1370	178
65	5600	625	1250	163	940	1880	245
75	4750	1280	2560	333	1920	3840	499
90	3750	2400	4800	624	3600	7200	936

> Torques for shaft fit with keyway

Size Δ	Max. shaft misalignment ²⁾		
	radial ¹⁾ $\Delta K_r / \text{mm}$	axial ¹⁾ $\Delta K_a / \text{mm}$	angular ¹⁾ $\Delta K_w / \text{Grad}$
19	0.20	1.2	1.2
24	0.22	1.4	0.9
28	0.25	1.5	0.9
38	0.28	1.8	1.0
42	0.32	2.0	1.0
48	0.36	2.1	1.1
55	0.38	2.2	1.1
65	0.42	2.6	1.2
75	0.48	3.0	1.2
90	0.50	3.4	1.2

1) The values mentioned are valid for 1.500 rpm and may occur only separately. At multiple misalignments or higher speeds the values must be reduced (see page 7).

2) The values mentioned are valid for an ambient temperature of 30 °C. At higher temperatures the values must be reduced.

TYPE HWN WITH KEYWAY MOUNTING

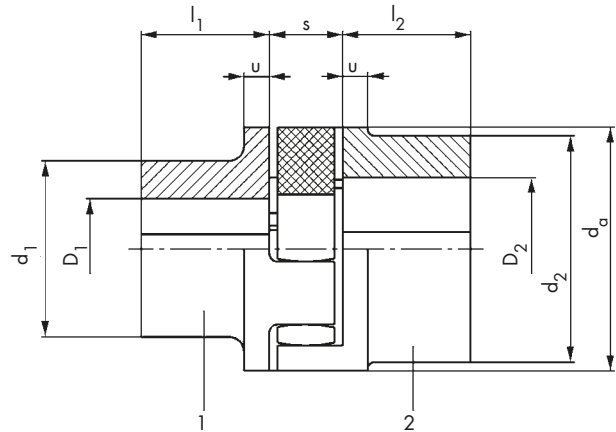
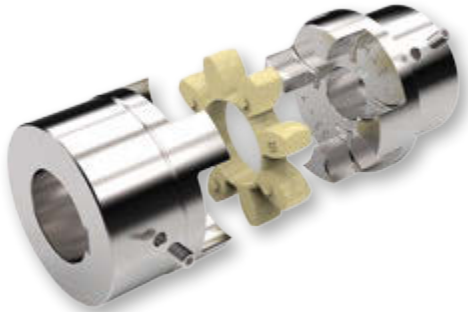

Size	Part 1				Part 2				da	u	s
	Pre. mm	max. mm	d ₁ mm	l ₁ mm	Pre. mm	max. mm	d ₂ mm	l ₂ mm			
19	–	19	32	25	17	24	39.5	25	40	5	16
24	–	24	40	30	22	28	48	30	55	6	18
28	–	28	48	35	26	38	64.5	35	65	7	20
38	10	38	66	45	36	45	78	45	80	8	24
42	12	42	75	50	40	55	94	50	95	10	26
48	13	48	85	56	46	60	104	56	105	11	28
55	18	55	98	65	53	70	118	65	120	13	30
65	20	65	115	75	63	75	134	75	135	14	35
75	28	75	135	85	73	90	158	85	160	16	40
90	38	90	160	100	88	100	180	100	200	19	45

Size	Weight / kg		Moments of inertia kgm ²	
	Part 1	Part 2	Part 1	Part 2
19	0.16	0.21	0.00003	0.00005
24	0.40	0.40	0.00011	0.00015
28	0.52	0.76	0.00024	0.00049
38	1.1	1.4	0.00087	0.0013
42	1.7	2.3	0.0018	0.0031
48	2.8	3.1	0.0031	0.0052
55	3.7	4.6	0.062	0.010
65	5.7	7.0	0.013	0.019
75	8.8	11	0.027	0.041
90	15	15	0.068	0.090

- Drill holes H7 with keyway in accordance with DIN 6885/1; tolerance zone JS9 and set screws on the keyway; weight and moments of inertia valid for medium bore diameters
- Coupling half materials: EN-GJL-250 (GG-25) in accordance with DIN EN 1561
- Possible combination:
 - 1/1
 - 1/2
 - 2/2
- Can also be combined with type HWT

TYPE HWT FOR TAPER BUSH

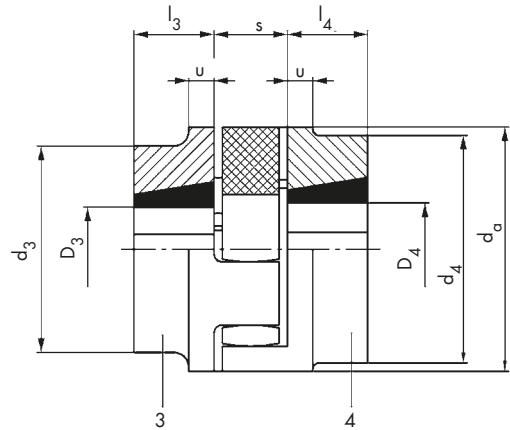

Size	Part 3					Part 4					da	u	s
	D ₃		Taper bush no.	d ₃	l ₃	D ₄		Taper bush no.	d ₄	l ₄			
	min. mm	max. mm				min. mm	max. mm						
19	-	-	-	-	-	-	-	-	-	-	40	5	16
24	10	25	1008	54.5	22	10	25	1008	54.5	22	55	6	18
28	10	28	1108	64.5	22	10	28	1108	64.5	22	65	7	20
38	10	28	1108	78	22	10	28	1108	78	22	80	8	24
42	14	42	1610	94	25	14	42	1610	94	25	95	10	26
48	14	42	1615	104	38	14	42	1615	104	38	105	11	28
55	14	50	2012	118	32	14	50	2012	118	32	120	13	30
65	14	50	2012	126	32	16	60	2517	134	45	135	14	35
75	16	60	2517	158	45	25	75	3020	158	51	160	16	40
90	25	75	3020	160	51	35	90	3535	180	89	200	19	45

Size	Weight kg		Moments of inertia kgm ²	
	Part 3	Part 4	Part 3	Part 4
19	-	-	-	-
24	0.39	0.39	0.00017	0.00017
28	0.55	0.55	0.00032	0.00032
38	0.86	0.86	0.00074	0.00074
42	1.4	1.4	0.0017	0.0017
48	2.5	2.5	0.0037	0.0037
55	2.7	2.7	0.0054	0.0054
65	3.4	4.8	0.0082	0.0012
75	6.8	7.3	0.023	0.026
90	9.5	16	0.044	0.081

- > Weight and moments of inertia valid for medium bore diameters inc. taper bushes
- > Coupling half materials:
EN-GJL-250 (GG-25) in accordance with DIN EN 1561
- > Possible combination:
3/3
3/4
4/4
- > Can also be combined with type HWN

TAPER BUSHES WITH KEYWAYS ACC. TO DIN 6885/1

TOLERANCE JS9



Taper bush no.	Bore \varnothing of available taper bushes mm											
1008	10	11	12	14	16	18	19	20	22	24*	25*	
1108	10	11	12	14	16	18	19	20	22	24	25	28*
1610/ 1615	14	16	18	19	20	22	24	25	28	30	32	35
	38	40	42*									
2012	14	16	18	19	20	22	24	25	28	30	32	35
	38	40	42	45	48	50						
2517	16	18	19	20	22	24	25	28	30	32	35	38
	40	42	45	48	50	55	60					
3020	25	28	30	32	35	38	40	42	45	48	50	55
	60	65	70	75								
3535	35	38	40	42	45	48	50	55	60	65	70	75
	80	85	90									

* These bore holes are with flat keyway in accordance with DIN 6885/3.

ALLOWABLE MISALIGNMENTS



Radial misalignment

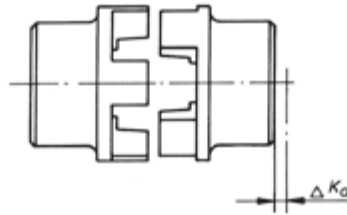

Axial misalignment



Angular misalignment

- Reduction of the allowable values of misalignment when the combination of misalignments occur or at other rotational speeds: $\frac{\Delta W_r}{\Delta K_r} + \frac{\Delta W_a}{\Delta K_a} + \frac{\Delta W_w}{\Delta K_w} \leq X$

$\Delta K_{r/a/w}$ = allowable radial, axial or angular misalignment of the shafts resp. of the coupling halves

$\Delta W_{r/a/w}$ = measured radial, axial or angular misalignment of the shafts resp. of the coupling halves.

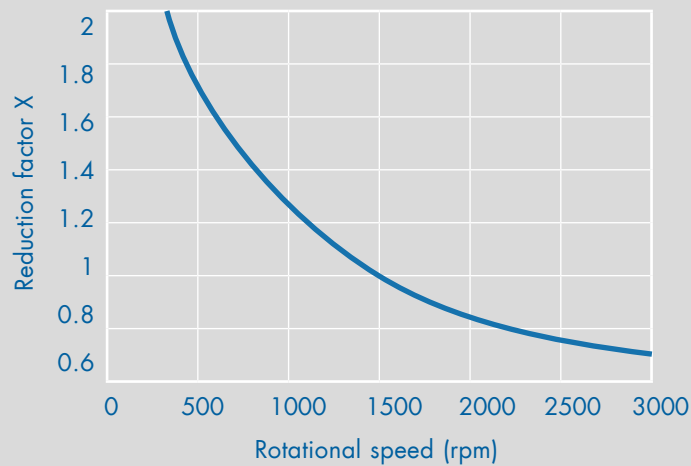

HABIX® PLUS

Habix®plus consist of two coupling hubs with curved jaws, which are produced with high concentricity.

The precision rating is made of an extremely wear-resistant and temperature-resistant plastic. Up to size 48 the clutch is constructed of high-strength aluminum, from size 65 it is constructed of steel.

The equalizing element of the Habix®plus HPN or HPK coupling is the star. It transmits torque without backlash or vibration. The high-precision star insert defines the characteristics of the entire drive system.

Backlash is eliminated by the press fit of the star into the hubs. The Habix®plus HPN or HPK couplings has been designed to compensate radial, axial and angular movements.

The flexible element of the Habix®plus coupling allows a permanent thermal load up to 100°C or 120°C. Even low temperatures up to -30°C are allowed.

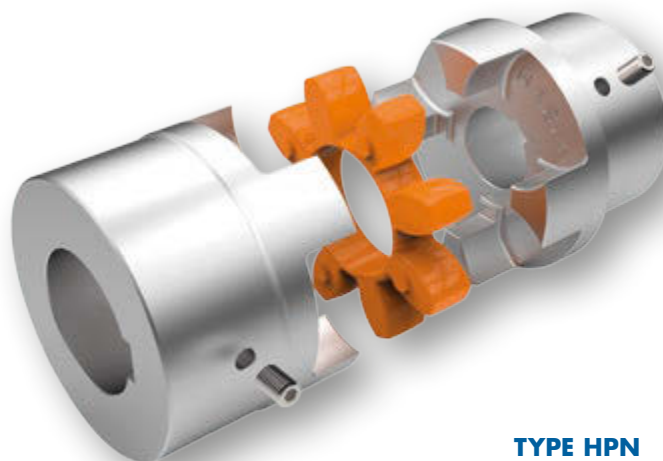

TYPE HPN

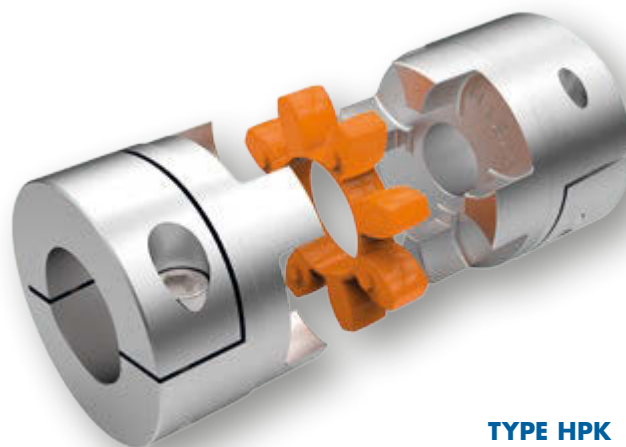

TYPE HPK

FEATURES

- > Cheap
- > High concentricity
- > Vibration-reducing
- > Electrically isolating
- > Pluggable

AREA OF APPLICATION

- > Servodrive technology
- > Machine tools
- > Packaging machinery
- > Automation systems
- > Printing machines
- > Control- and positioning technique
- > General mechanical engineering

TECHNICAL DATA

TYPE HPN/HPK

Size	Speed rpm	Torque Nm		Torque Nm	
		nominal T	max. T	nominal T	max. T
		98 Shore A color orange		64 Shore D color green	
19	19 000	17	34	21	42
24	14 000	60	120	75	150
28	11 500	160	320	200	400
38	9 500	325	650	405	810
48	8 000	530	1060	660	1350
65	4 000	950	1900	1100	2150

> Maximum transmittable torque in accordance with the bore diameter of the clamping hub
At speeds over 10 000 rpm a precision balancing is necessary.

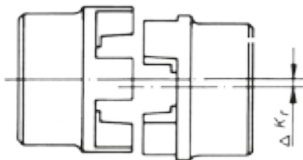

Radial misalignment

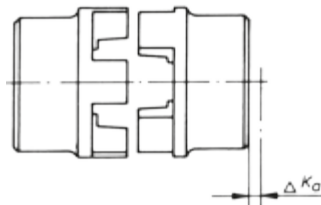

Axial misalignment

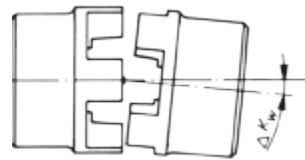

Angular misalignment

Size	Star	Radial misalignment [mm]	Axial misalignment [mm]	Angular misalignment [degree]
19	98 Shore A	0.1	±2	1
	64 Shore D	0.08		0.8
24	98 Shore A	0.12	±2	1
	64 Shore D	0.1		0.8
28	98 Shore A	0.15	±2	1
	64 Shore D	0.12		0.8
38	98 Shore A	0.18	±2	1
	64 Shore D	0.14		0.8
48	98 Shore A	0.2	±2	1
	64 Shore D	0.18		0.8
65	98 Shore A	0.25	±2	1
	64 Shore D	0.2		0.8

Shore hardness
98 Sh A



Shore hardness
64 Sh D



TYPE HPN

WITH KEYWAY MOUNTING

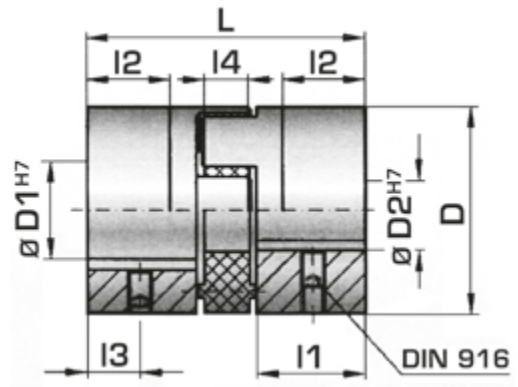
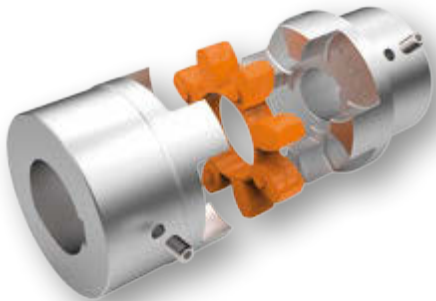

Size	D mm	D1/2 mm	l1 mm	l2 mm	l3 mm	l4 mm	L mm	Weight kg
19	42	8 - 25	25	19	8.5	12	66	0.15
24	56	12 - 32	30	22	10	14	78	0.35
28	66.5	19 - 38	35	26	12	15	90	0.6
38	82	20 - 45	45	32	15	18	114	1.1
48	102	28 - 60	50	37	17.5	20	126	1.7
65	136.5	32 - 80	65	43	23	25	162	11

- Drill holes H7 with keyway in accordance with DIN 6885/1
- Set screws on the keyway
- Optionally pilot bore
- Weights valid for medium bore diameters

TYPE HPK

WITH CLAMPING HUB

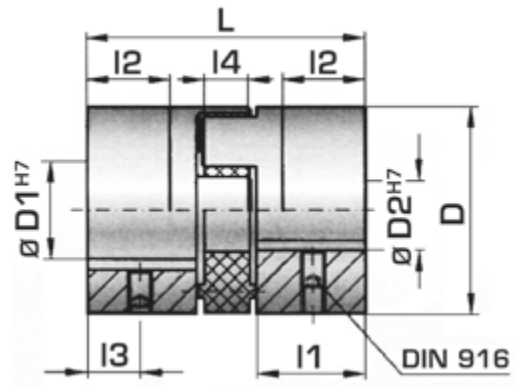
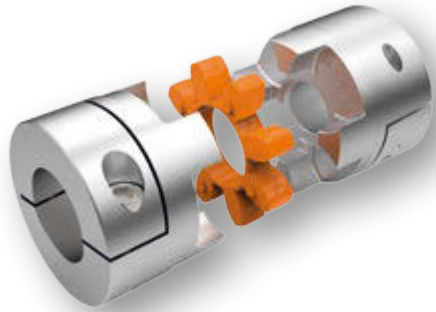

Size	D mm	D1/2 mm	l1 mm	l2 mm	l3 mm	L mm	Weight kg
19	42	8 - 25	25	39	8.5	66	0.15
24	56	12 - 32	30	46	10	78	0.35
28	66.5	19 - 38	35	52.5	12	90	0.6
38	82	20 - 45	45	66	15	114	1.1
48	102	28 - 60	50	73	17.5	126	1.7
65	136.5	32 - 80	65	93.5	23	162	11

MAXIMUM TRANSMITTABLE TORQUE IN ACCORDANCE WITH THE BORE DIAMETER OF THE CLAMPING HUB (NM)

Size	ø 8	ø 16	ø 19	ø 25	ø 30	ø 32	ø 35	ø 45	ø 50	ø 55	ø 60	ø 65	ø 70	ø 75	ø 80
19	20	35	45	60											
24		50	80	100	110	120									
28			120	160	180	200	220								
38			200	230	300	350	380	420							
48					420	480	510	600	660	750	850				
65							700	750	800	835	865	900	925	950	1000

> Higher torques with additional keyway possible!

ALLOCATION TO IEC MOTOR

Size of the three-phase motor	Power P of the IEC motors and allocated Habix® couplings								Shaft ends	
	3000 rpm		1500 rpm		1000 rpm		750 rpm		Form E DIN 748 part 3 d x l at speed approx.	
	P kw	Habix® size	P kw	Habix® size	P kw	Habix® size	P kw	Habix® size	3000 rpm	1500 rpm and less
56	0.09	19	0.06	19	0.037	19	–		9 x 20	
	0.12	19	0.09	19	0.045	19	–			
63	0.18	19	0.12	19	0.06	19	–		11 x 23	
	0.25	19	0.18	19	0.09	19	–			
71	0.37	19	0.25	19	0.18	19	0.09	19	14 x 30	
	0.55	19	0.37	19	0.25	19	0.12	19		
80	0.75	19	0.55	19	0.37	19	0.18	19	19 x 40	
	1.1	19	0.75	19	0.55	19	0.25	19		
90 S	1.5	24	1.1	24	0.75	24	0.37	24	24 x 50	
90 L	2.2	24	1.5	24	1.1	24	0.55	24	24 x 50	
100 L	3	28	2.2	28	1.5	28	0.75	28	28 x 60	
	–	–	3	28	–	–	1.1	28		
112 M	4	28	4	28	2.2	28	1.5	28	28 x 60	
132 S	5.5	38	5.5	38	3	38	2.2	38	38 x 80	
	7.5	38	–	–	–	–	–	–		
132 M	–	–	7.5	38	4	38	3	38	38 x 80	
	–	–	–	–	5.5	38	–	–		
160 M	11	42	11	42	7.5	42	4	42	42 x 110	
	15	42	–	–	–	–	5.5	42		
160 L	18.5	42	15	42	11	42	7.5	42	42 x 110	
180 M	22	48	18.5	48	–	–	–	–	48 x 110	
180 L	–	–	22	48	15	48	11	48	48 x 110	
200 L	30	55	30	55	18.5	55	15	55	55 x 110	
	37	55	–	–	22	55	–	–		
225 S	–	–	37	65	–	–	18.5	65	55 x 110	60 x 140
225 M	45	55	45	65	30	65	22	65	55 x 110	60 x 140
250 M	55	65	55	65	37	65	30	65	60 x 140	65 x 140
280 S	75	65	75	75	45	75	37	75	65 x 140	75 x 140
280 M	90	65	90	75	55	75	45	75	65 x 140	75 x 140
315 S	110	65	110	90	75	90	55	90	65 x 140	80 x 170
315 M	132	65	132	90	90	90	75	90	65 x 140	80 x 170
315 L	160	65	160	90	110	90	90	90	65 x 140	80 x 170
	200	75	200	90	132	90	110	90	–	–
355 L	250	75	250	90	160	90	132	90	–	–
	315	90	315	90	200	90	160	–	75 x 140	95 x 170
400 L	–	–	–	–	250	–	200	–	–	–
	355	90	355	–	315	–	250	–	80 x 170	100 x 210
	400	90	400	–	–	–	–	–	–	–

- > As proposed in the table (page 12) for surface cooled three-phase motors with cage rotor acc. to DIN 42673, page 1 (data for motor 56, 63, 71, 80, 315 L, 355 L, 400 L, see catalogue Siemens).

This allocation is a preliminary selection for normal conditions of operation.
 For conditions of operation under shock and changing loads the selection must be made according to the following.

SELECTION

- > The torque of the machine T_{AN} is determined by:

$$T_{AN} \text{ [Nm]} = 9550 \times \frac{P_{Motor} \text{ [kW]}}{n \text{ [rpm]}}$$

- > This torque T_{AN} multiplied by a safety factor S depending on the application and the temperature factor S_T (see table page 14) gives the required nominal coupling torque T_{KN} .

Result: $T_{KN} \geq S \times S_T \times T_{AN}$

DESIGN EXAMPLE FOR IEC STANDARD MOTORS

Dates of the plant

Driving machine:	
three-phase motor	225 M
Power of the motor:	P = 45 kW
Rotation at speed:	n = 1485 rpm
Driven machine:	mixer
Ambient temperature:	+50 °C

Layout of the coupling

$$T_{AN} \text{ [Nm]} = 9550 \times \frac{45 \text{ kW}}{1485 \text{ rpm}} = 290 \text{ Nm}$$

$$T_{KN} = 1.25 \times 1.5 \times 290 \text{ Nm} = 544 \text{ Nm}$$

- > Selection:
 Habix® size 65 flexible element 92° Shore A

$$T_{KN} = 625 \text{ Nm}$$

- > In case that bigger shock or changing loads occur we recommend a revision according to DIN 740.

An adequate calculation program is available.
 For such a revision the following information is required:

1. Kind of the driving machine
2. Kind of the driven machine
3. Power of driving and driven machines
4. Rotational speed of operation
5. Shock loads
6. Exciting loads
7. Moments of inertia of load- and driving sides
8. Starts per hour
9. Ambient temperature

SAFETY FACTOR S

Assignment of load characteristics according to type of working machine

S	DREDGERS	S	RUBBER MACHINERY	S	PUMPS
S	Bucket conveyor	M	Extruders	G	Piston pumps
M	Landing gear (caterpillar)	S	Calenders	M	Centrifugal pumps (light liquids)
M	Landing gear (rail)	M	Kneading mills	S	Centrifugal pumps (viscous liquids)
M	Manoeuvring winches	S	Mixers	S	Plunger pumps
M	Pumps	S	Rolling mills	S	Press pumps
S	Impellers				
S	Cutter heads		WOOD WORKING MACHINES		STONE AND CLAY WORKING MACHINES
M	Slewing gear	S	Barkers	S	Crusher
		M	Planing machines	S	Rotary ovens
		G	Wood working machines	S	Hammer mills
		S	Saw frames	S	Ball mills
				S	Tube mills
M	GENERATORS, TRANSFORMERS			S	Beater mills
M	Frequency transformers		CRANES	S	Brick presses
M	Generators	G	Luffing gear block		
M	Welding generators	S	Travelling gear		TEXTILE MACHINES
		G	Hoist gear	M	Batchers
		M	Slewing gear	M	Printing and dyeing machines
		M	Derricking jib gear	M	Tanning vats
				M	Willows
				M	Looms
					COMPRESSORS
				S	Piston compressors
				M	Turbo compressors
					METAL ROLLING MILLS
				S	Plate shears
				M	Manipulator for turning sheets
				S	Ingot pushers
				S	Ingot and slabbing-mill train
				S	Ingot handling machinery
				M	Wire drawing benches
				S	Descaling machines
				S	Thin plate mills
				S	Heavy and medium plate mills
				M	Winding machines (strip and wire)
				S	Cold rolling mills
				M	Chain tractor
				S	Billet shears
				M	Cooling beds
				M	Cross tractor
				M	Roller tables (light)
				S	Roller tables (heavy)
				M	Roller straighteners
				S	Tube welding machines
				M	Trimming shears
				S	Cropping shears
				S	Continuous casting plant
				M	Rollers adjustment drive
				S	Manipulators
					LAUNDRIES
				M	Tumblers
				M	Washing machines
					WATER TREATMENT
				M	Aerators
				M	Screw pumps

Operating factor S			
Driving machines	Load characteristics of the working machine		
	G	M	S
Electric motors, turbines, hydraulic motors	1	1.25	1.75
Piston machines 4–6 cylinders, degree of nonuniformity 1:100 – 1:200	1.25	1.5	2
Piston machines 1–3 cylinders, degree of nonuniformity up to 1:100	1.5	2	2.5

Habix®	
Temperature factor S _T	
θ [°C]	S _T
–20° to +30°	1.0
+30° to +40°	1.2
+40° to +60°	1.5
+60° to +80°	1.8

Habix®plus		
Temperature factor S _T		
θ [°C]	Shore 98 A	Shore 64 D
–30° to –10°	1.5	1.7
–10° to +30°	1.0	1.0
+30° to +40°	1.2	1.1
+40° to +60°	1.4	1.3
+60° to +80°	1.7	1.5
+80° to +100°	2.0	1.8
+100° to +120°	–	2.4