

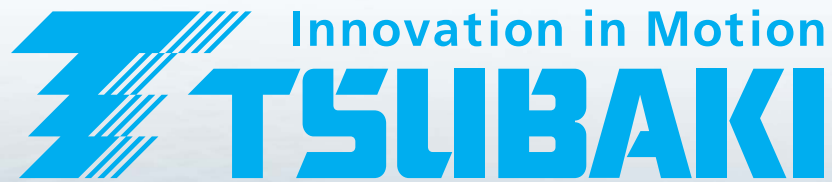

Tsubaki Power and Performance for the Pulp and Paper Industry





At Tsubaki we know customers want the best. Indeed, we take pride in our ability to deliver an extensive product line up that satisfies these high expectations. We are also aware that each and every one of our customers has unique requirements. Therefore, we believe that in coming years there will be an increase in demand for products that can be readily applied to customers' global operational strategies. In other words, we foresee a rise in the need for highly customized products.

Innovation in Motion. With an eye on future trends and lifestyles, we are committed to taking on the challenge of technical innovation. Based on our brand message, which incorporates that commitment and is shared by all Group members around the world, the Tsubaki Group provides solid support for the global business activities of its customers. You can count on Tsubaki.

Tsubaki Mission Statement

Our Mission

We will provide the best value to customers around the world by capitalizing on our technical strengths in power transmission products and materials handling systems.

Our Vision

We aim to be a leading company in the global market for our products.

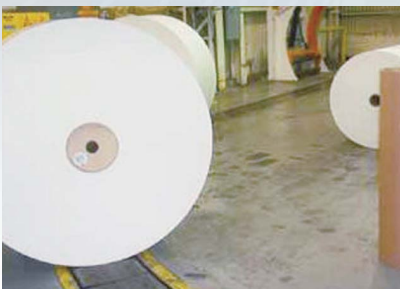

Global Network

The Tsubaki Group includes 28 production locations and 35 group companies worldwide. Our production and sales networks are more fully developed than ever.

Global Alliances

We continue to aggressively pursue operational alliances, mergers, and technical alliances with companies in Japan and throughout the world.

TSUBAKI Global Business

Best Source/ Best Supply

Through global development of our network, we constantly seek the best combination of regions based on product distribution and market feedback.

Global Marketing

With a keen grasp on the needs of customers, we use the Group's comprehensive strengths to commercialize products rapidly.



You'll find Tsubaki products used

There are many processes involved in making paper. You'll find Tsubaki products throughout these processes, from where wood chips and waste paper are made into pulp to web transport and paper shipping. Tsubaki puts nearly a century of know-how to bring quality and technical expertise to paper manufacturers, paper processors, paper manufacturing equipment manufacturers, and biomass power generators worldwide.

Pulp Manufacturing Process

Kraft Process

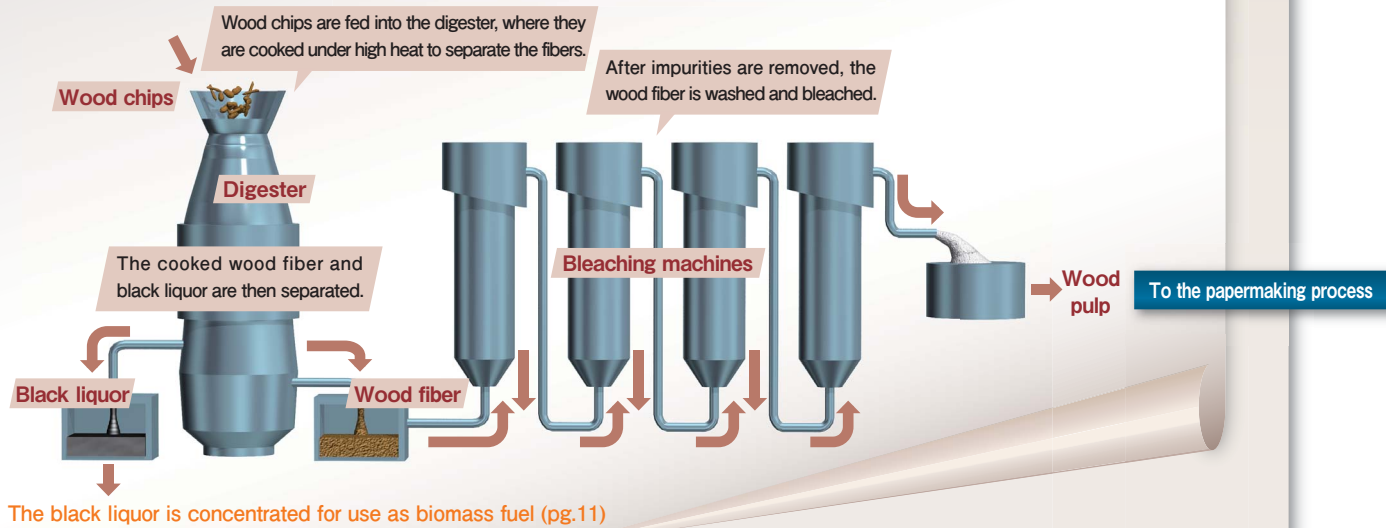

Waste Paper Pulp Manufacturing Process

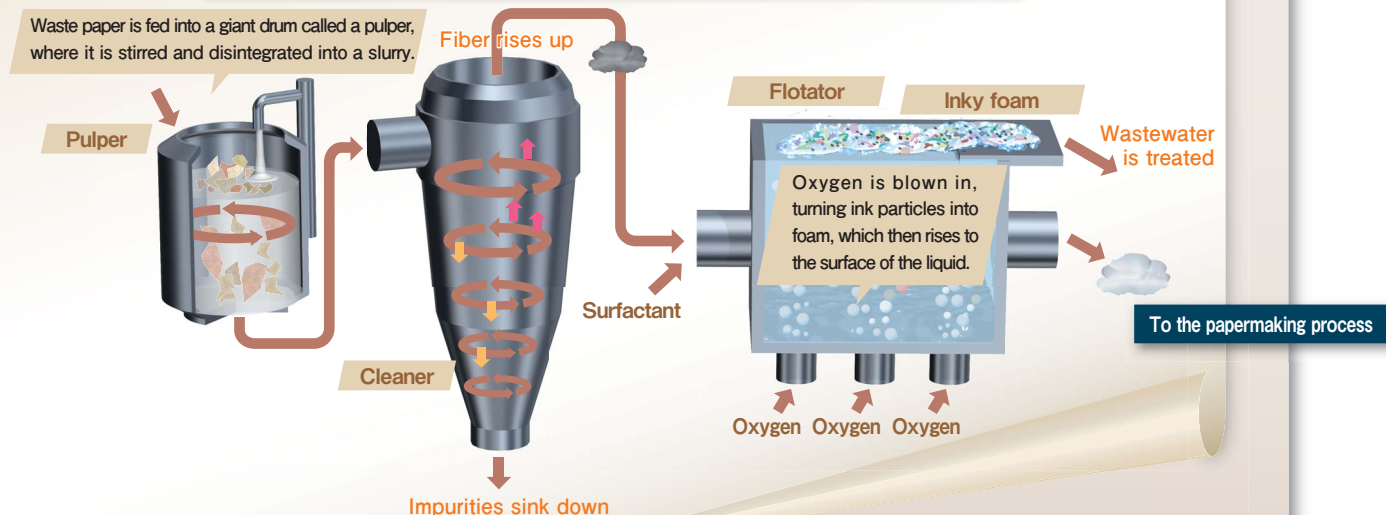

throughout the pulp and paper industry

Tsubaki products used in drive areas..... Pg.5

Tsubaki products used in conveyor areas... Pg.8

Papermaking, Surface Treatment, and Finishing

Papermaking Machine

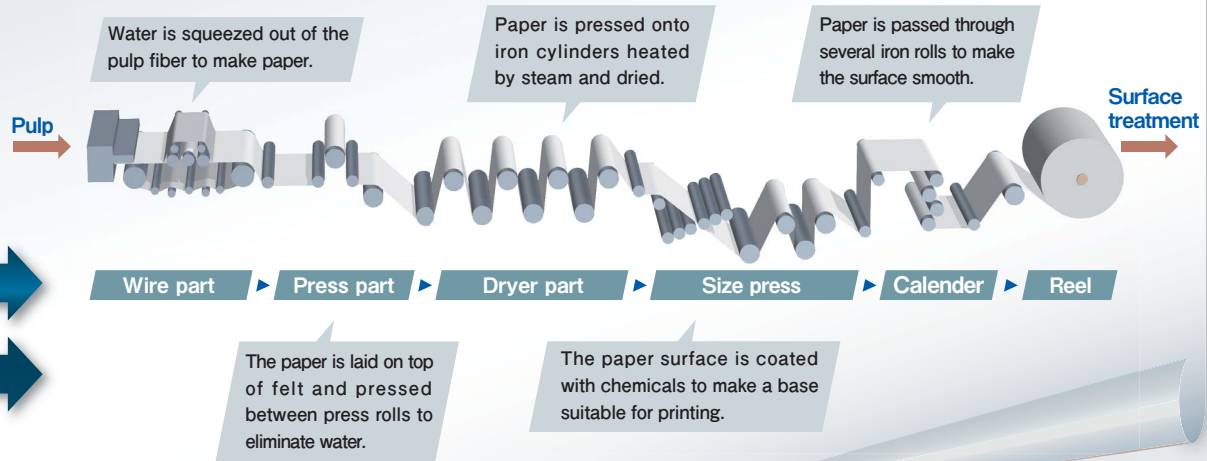

To the coating process

Coating machine

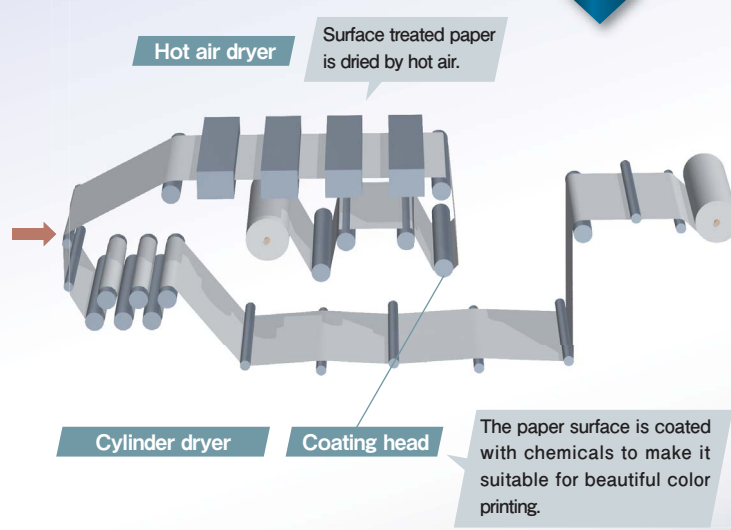

Super-calender

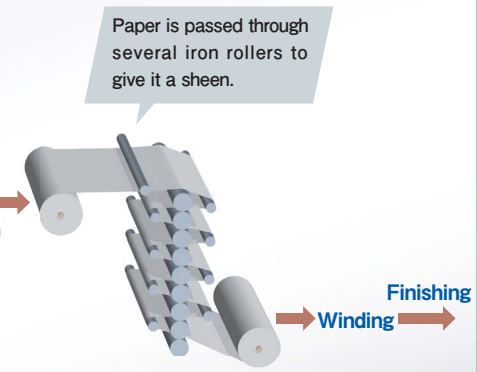

1 Drive Area

Tsubaki offers a wide line-up of power transmission parts and units, from our global market dominating chains to reducers and couplings. Tsubaki – providing solutions to solve customer problems worldwide.

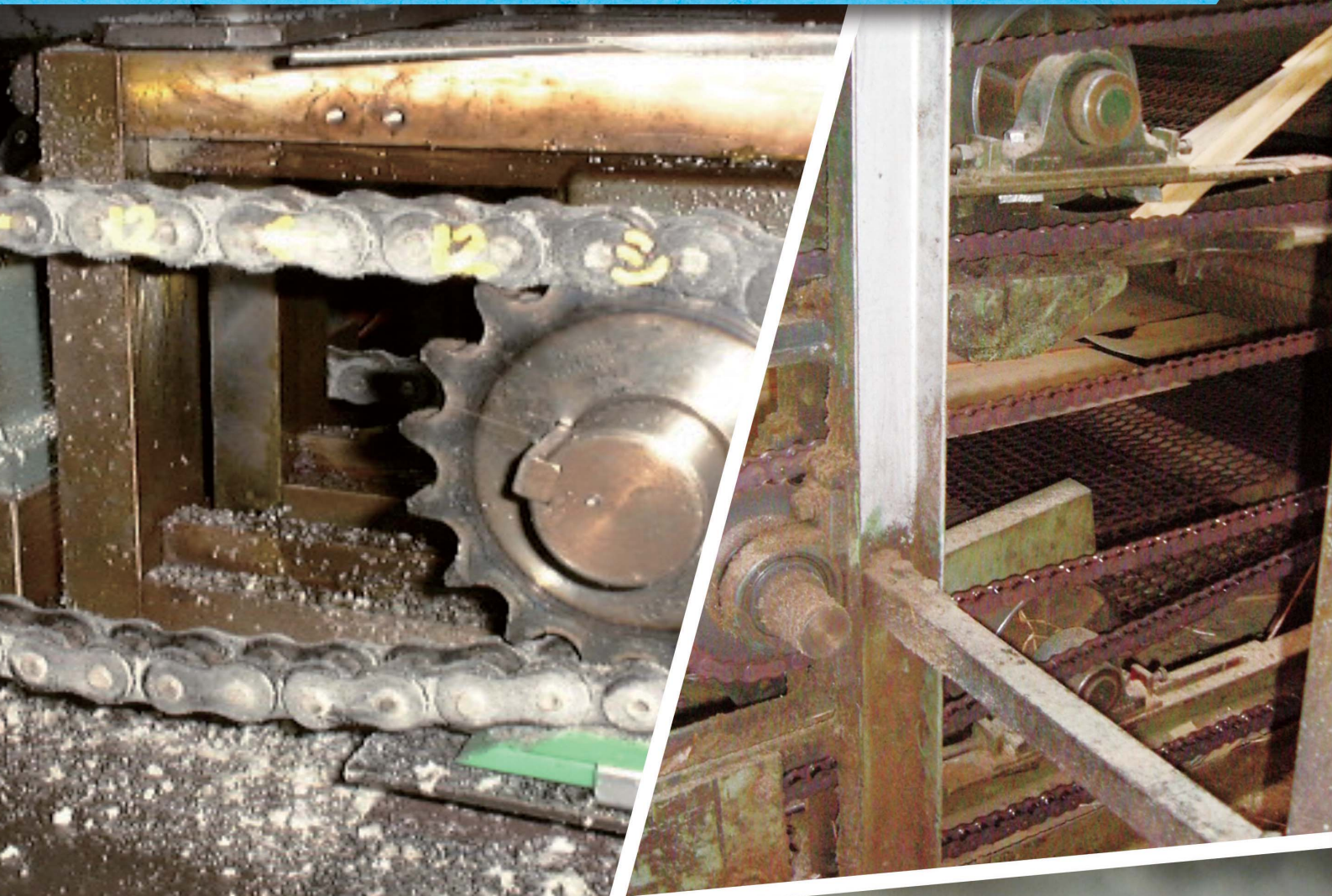

Tsubaki Lambda Chain



Special oil impregnated bushes give the chain long life without additional lubrication. For even longer life, Tsubaki offers X-Lambda Chain.

Merits

Reduced maintenance and replacement costs.

Offers vastly increased wear life compared to general roller chain in unlubricated operating conditions.

Heavy Duty Drive Chain

Features a thicker, wider plate than with general drive chains, allowing for more compact designs, superior drive performance, and higher allowable loads.

Comparison of Minimum Tensile Strength and Maximum Allowable Load

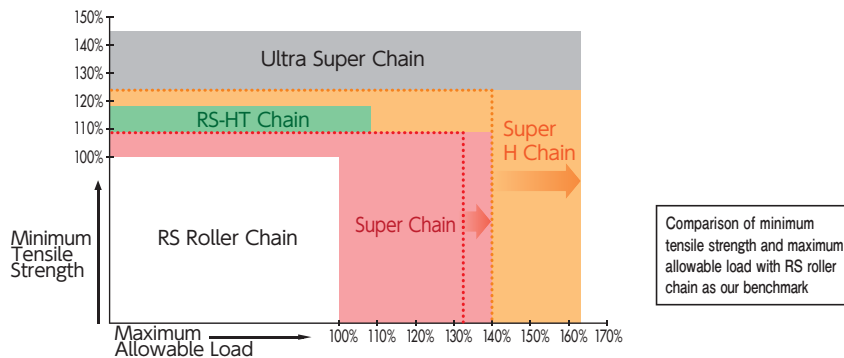

Comparison of minimum tensile strength and maximum allowable load with RS roller chain as our benchmark



Super Chain

By increasing the size of the link plate waist, Super Chain offers ~40% higher maximum allowable load than with general roller chain.



RS-HT Chain

Thicker link plates give RS-HT Chain ~20% higher tensile strength than general roller chain.



Super H Chain

Link plates have the same shape as with Super Chain, but thicker. Ideal for conditions requiring higher allowable load, tensile strength, and shock absorption.



Ultra Super Chain

Features thick oval link plates. Has the top allowable load, tensile strength, and shock absorption, allowing for compact designs.

Drive Chain Sprockets



Tsubaki drive chain sprockets have a deep hardened layer over the entire sprocket, down to the teeth valleys, giving the teeth excellent wear resistance for long service life. We offer a wide range of teeth numbers, rows, shapes, bore finishing, and shaft locking devices.

Comparison of Hardened Layers



Tsubaki Drive Chain Sprockets



Co. A



Co. B

Echt-Flex Couplings



Echt-Flex Couplings are lube-free, non-backlash couplings with high torsional rigidity that can maximize the features of servo motors. Discs with FEM optimized shapes can reliably transmit torque while flexibly absorbing misalignment.

● NEF Taper Lock Series Echt-Flex Couplings

Taper locks provide both compact designs and high torque transmission. The perfectly shaped taper gives the coupling high rigidity and flexibility.

Worm Reducers



Tsubaki offers both cylindrical worm reducers (Worm Power Drives) and drum worm reducers (Trois Drives) in a wide range of styles to meet any need.

Merits

- Complete line-up in any size.
- Users can select high performance drum type Trois Drives or high balance cylindrical worms to perfectly match their needs.
- Available with a case with integrated feet or an on-shaft/flange mounting case.

Miter Gear Boxes



A line shaft drive that distributes power to either side or across several shafts.

Merits

Provides simple periodic motion from one motor drive. Allows for compact equipment design.

2 Conveyor Area

Tsubaki's technical prowess in material handling through its conveyor chains, linear actuators, and other products provide the best solution for our global customer conveyor needs.



Web Conveyance

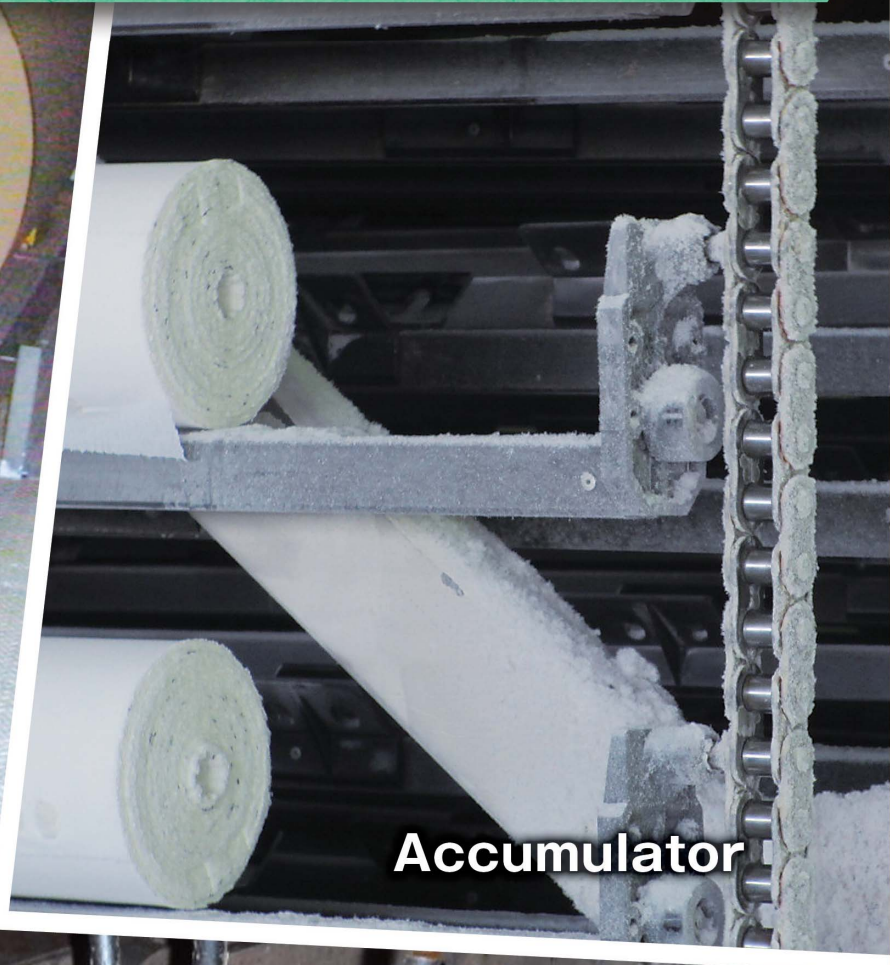

Accumulator



Wood Chip Conveyance

Large Size Conveyor Chain

● Bearing Roller Conveyor Chain

A unique Tsubaki chain with cylindrical bearings inside the roller itself. Our line-up includes dust-resistant, water-resistant, and lube-free series chains.



Previous Series

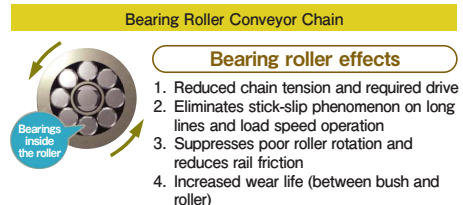
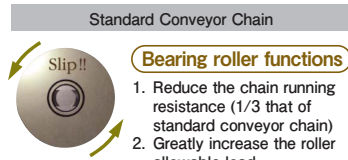

Dust Resistant Specifications



Standard Lube-free Specifications



Completely Lube Free Specifications

Digester Chain



Digester chains are used in cooking chemi-ground and semi-ground pulp. Features the perfect combination of material and heat treatment for long service life.

Cam Clutches



● BS Series (for backstops)

Cam Clutches prevent low speed backstops on conveyors and other equipment. Offers complete dust resistance and high reliability thanks to its special cams.

Merits

Its specially developed cams and unique cam - roller arrangement provide high impact resistance, wear resistance, and good lubrication conditions.

Power Cylinders



The Tsubaki Power Cylinder is an electrical cylinder that can be used with just simple wiring.

Maintenance is a snap, with no need for the type of troublesome piping seen on hydraulic and pneumatic cylinders. A range of thrusts is available in a variety of options. They can be installed in a variety of load protection devices for safe use.

Power Cylinders use a highly efficient ball screw for long life even under high speed/high frequency operation.



Small Size Conveyor Chain

You'll find Tsubaki Small Size Conveyor Chains at work in all paper manufacturing processes.

● General Use Small Size Conveyor Chain (Double Pitch Chain, RS Attachment Chain)

Extended Pin Chain



Jigs can be attached to extended pins for conveyance.

RS Hollow Pin Chain



The pins have holes in them to allow attachments to be installed.

Double Pitch Chain with top rollers



Available as double strand chain with more conveying power than single strand chain.

NEP Series Double Pitch Chain



Provides excellent resistance to saltwater, climate, and overall corrosion while still being extremely durable.

● BS Attachment Chain

Tsubaki BS Attachment Chain can replace European chains already installed on European equipment without needing to replace the sprocket.

BS Attachment Chain



Standard BS Chain with attachments.

Special Attachment Chain



Features threaded extended pins for attaching jigs and the like with nuts.

BS Alternating Pitch Chain



Combines BS Double Pitch Chain and BS short pitch chain.

Stainless Steel Attachment Chain (SS/AS Series)



Small size corrosion resistant BS Chain.

● Lube-free Small Size Conveyor Chain

In addition to standard attachment chains, Tsubaki offers integrated attachment chains to meet the application, equipment, environmental, and conveyance needs of our customers.

Double Pitch Lambda Chain



Available with special attachments to meet your conveyance needs.

RF Lambda Roller Chain



Will not contaminate conveyed goods. Ideal for directly conveying pallets and other goods.

TS Series Lambda Top Chain



Conveyed goods can be placed directly on the chain. The base chain can be difficult to lubricate, making Lambda Chain an ideal choice.

BS Lambda Chain with rubber attachments

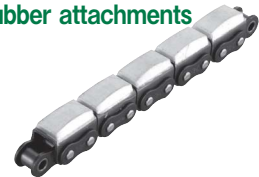

Special rubber attachments are baked onto the chain.

● X-Lambda Chain (long life Lambda Chain)

X-Lambda Chain uses oil impregnated felt seals to give it greatly increased wear life over Lambda Chain. Perfect for users that want to even further extend the replacement cycle of their current Lambda Chain.

● KF Series Lambda Chain

Uses a special lubricant that won't break down easily in high temperature environments (150°C to 230°C) to give this Lambda Chain series maximum wear resistance in high temp environments.

Tsubaki Lambda Chain contributes to...

reduced
maintenance times

much lower chain
replacement costs

better equipment
reliability

increased
productivity

3 Wood Biomass Power Generation Equipment

You'll find many Tsubaki products at work in biomass power generation, where wood chips and waste lumber is burned to create power.

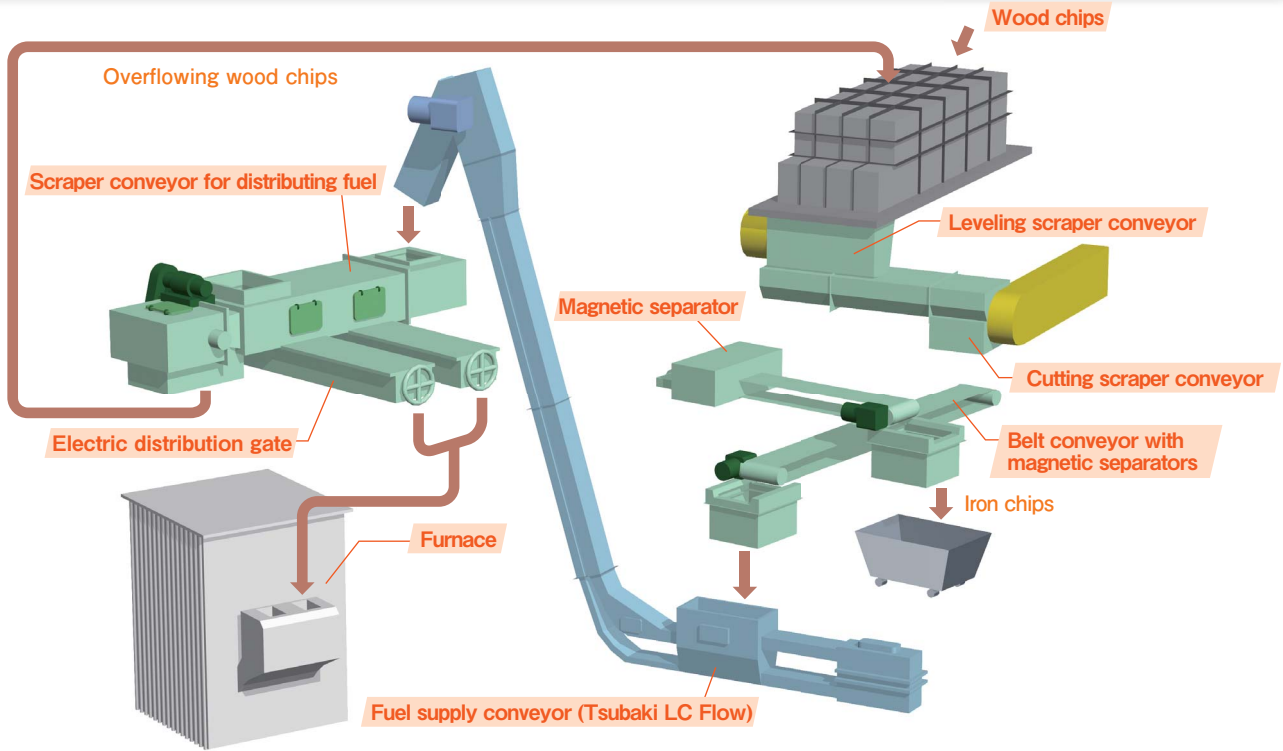

Tsubaki LC Flow

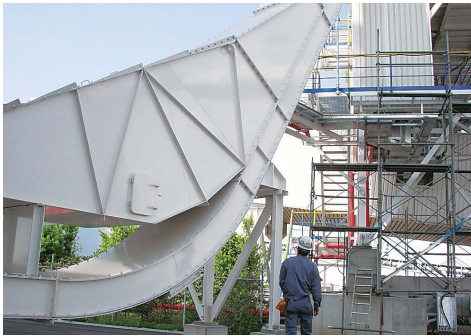

Features

- 1 Compact and economical (Dia. 1)
- 2 Feed flexibility (Dia. 2)
- 3 Uses the optimal conveyor chain (Dia. 3)
- 4 Simple inspection and maintenance
- 5 Dust and water proof construction

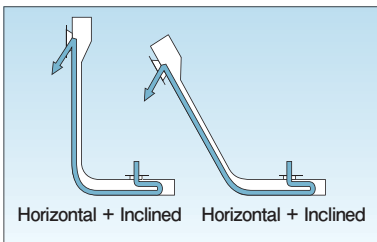

(Dia. 1)

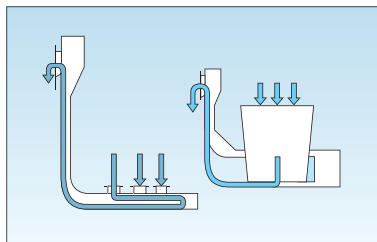

(Dia. 2)

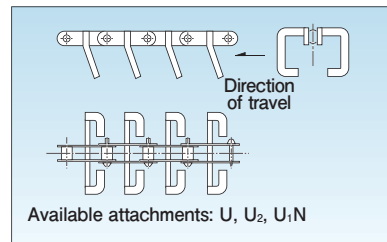

(Dia. 3)

Contact a Tsubaki representative for more information.

Other Solutions for the Pulp and Paper Industry

FB Series Conveyor Chain

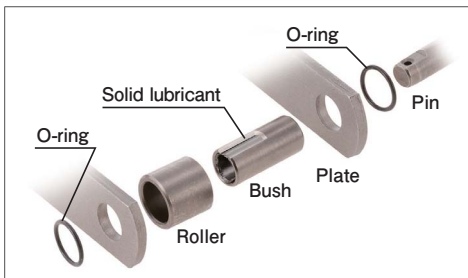

A solid lubricant is bonded between the pins and bushes, and an O-ring attached between links.

Merits

The solid lubricant minimizes chain elongation (pitch elongation), while the O-ring prevents conveyed material from infiltrating between pins and bushes – and prevents the solid lubricant from escaping – giving FB Series twice the life of standard Bucket Elevator Chain.

Thermally Sprayed Replaceable Tooth Sprockets

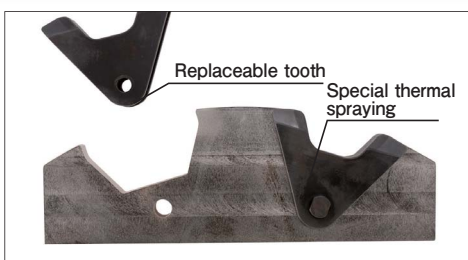

The sprocket teeth are replaceable, and the tooth valleys have been specially thermally sprayed.

Merits

The entire replaceable tooth is hardened, and the valley is specially thermally sprayed, giving the sprocket twice the wear life.



TSUBAKIMOTO CHAIN CO.

Japan	Tsubakimoto Chain Co.	https://tsubakimoto.com/
-------	-----------------------	---

Global Group Companies

AMERICAS

United States	U.S. Tsubaki Power Transmission, LLC	https://www.ustsubaki.com/
Brazil	Tsubaki Brasil Equipamentos Industriais Ltda.	https://tsubaki.ind.br/
Canada	Tsubaki of Canada Limited	https://tsubaki.ca/

EUROPE

Netherlands	Tsubakimoto Europe B.V.	https://tsubaki.eu/
France	Kabelschlepp France S.A.R.L.	https://tsubaki-kabelschlepp.com/fr-fr/
Germany	Tsubaki Deutschland GmbH	https://tsubaki.de/
	Tsubaki Kabelschlepp GmbH	https://tsubaki-kabelschlepp.com/de-de/
Italy	Kabelschlepp Italia S.R.L.	https://tsubaki-kabelschlepp.com/it-it/
Spain	Tsubaki Ibérica Power Transmission S.L.	https://tsubaki.es/
United Kingdom	Tsubakimoto UK Ltd.	https://tsubaki.eu/
Slovakia	Kabelschlepp-Systemtechnik, spol. s.r.o.	https://tsubaki-kabelschlepp.com/sk-sk/
Poland	Kabelschlepp Sp. z o.o.	https://kabelschlepp.pl/

INDIAN OCEAN RIM

Singapore	Tsubakimoto Singapore Pte. Ltd.	https://tsubaki.sg/
Australia	Tsubaki Australia Pty. Limited	https://tsubaki.com.au/
India	Tsubaki India Power Transmission Private Limited	https://en.tsubaki.in/
Indonesia	PT. Tsubaki Indonesia Trading	https://tsubaki.id/
Malaysia	Tsubaki Power Transmission (Malaysia) Sdn. Bhd.	https://en.tsubaki.my/
New Zealand	Tsubaki Australia Pty. Limited - New Zealand Branch	https://tsubaki.com.au/
Philippines	Tsubakimoto Philippines Corporation	https://en.tsubaki.ph/
Thailand	Tsubakimoto (Thailand) Co., Ltd.	https://tsubaki.co.th/
Vietnam	Tsubakimoto Vietnam Co., Ltd.	https://tsubaki.net.vn/

EAST ASIA

Republic of Korea	Tsubakimoto Korea Co., Ltd.	https://tsubakimoto-tck.co.kr/
Taiwan	Taiwan Tsubakimoto Trading Co., Ltd.	https://tsubakimoto.tw/

CHINA

China	Tsubakimoto Chain (Shanghai) Co., Ltd.	https://www.tsubaki-sh.cn/
-------	--	---
