



Handling Systems

Aluminum Crane Systems

WWW.SCHMALZ.COM/CRANES

Schmalz: Vacuum Technology for Intelligent Automation and Ergonomic Handling

1800
employees
working hard for our customers.

29
locations
for outstanding customer service worldwide.

9
percent
of our revenue is invested in innovative ideas and new products.

590
copyrights
are proof of our groundbreaking innovations.



Schmalz is the Market Leader in Vacuum Automation and Ergonomic Handling Systems.

The wide range of products in the Vacuum Automation unit includes individual components such as suction cups and vacuum generators, as well as complete gripping systems and clamping solutions for holding workpieces, for example in CNC machining centers. The Handling Systems unit offers innovative handling solutions with vacuum lifters and crane systems for industrial and handicraft applications.

Our products are used in different applications for example in the logistics industry, the automotive industry, the electronics sector and in furniture production.

With comprehensive consulting, a focus on innovation and first-class quality, Schmalz offers its customers long-lasting benefits. Schmalz's intelligent solutions make production and logistics processes more flexible and efficient, while also preparing them for the increasing trend toward digitalization.

Vacuum Automation

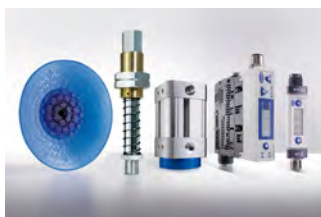

Components



Systems



Clamping solutions

Handling Systems



Vacuum lifters and crane systems

Aluminum Crane Systems from Schmalz

APPLICATIONS



6 Aluminum Crane Systems in Use



18 Modular Crane Gantry KBG
Simple and Flexible Steel Structure Configured According to Individual Customer Applications



28 Chain Hoists
Robust Hoists for Loads Weighing up to 2,500 kg

PRODUCTS



10 Aluminum Overhead Crane Systems
Flexible Crane Solutions for Large Working Areas and Loads Weighing up to 1,200 kg



22 Aluminum Column Mounted Jib Cranes and Wall Mounted Jib Cranes
Ergonomic Workplace Crane Solutions for Loads Weighing up to 1.000 kg

SERVICE AND CONTACT



30 Schmalz Services

Questionnaire for Design of Crane Systems

Contact



Certified Ergonomics

The vacuum lifters and crane systems from Schmalz support the back and musculoskeletal system when lifting light and heavy loads. They reduce strain and help to make the working environment ergonomic. This is confirmed by the independent association Aktion Gesunder Rücken e. V. (AGR) with its seal of approval.

 WWW.SCHMALZ.COM/CRANES



“We now work more quickly and ergonomically.”

Jürgen Retelstorf, Team Leader External Material Flow at Bossard AG: “Each day we commission around 2,000 cardboard boxes with fastening parts for global distribution at our central warehouse. This task used to be a great strain on our employees. With the aluminum crane system from Schmalz the work is now no trouble at all. We are indeed quicker because the handling of the packages is no longer so exhausting. We are also fully satisfied with the support we receive from Schmalz.”

Aluminum Crane Systems from Schmalz

Overview of Highlights



HIGH LEVEL OF ERGONOMICS DUE TO PERFECT LOW FRICTION

- Easy and ergonomic handling of loads due to optimal weight-load ratio
- Low force required during start-up thanks to special low friction rollers
- Fewer absences due to health problems and greater employee satisfaction
- Awarded the seal of approval of the Aktion Gesunder Rücken e. V. (campaign for a healthy back)

HANDLING EFFORT REDUCED BY OVER 60%

The force diagram is an impressive example of the benefit gained from Schmalz aluminum crane systems. In comparison to conventional crane systems made from steel, the user saves more than 60 percent of the force required to move loads. This allows even heavy loads to be handled effortlessly and safely.

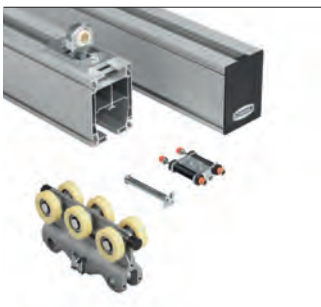
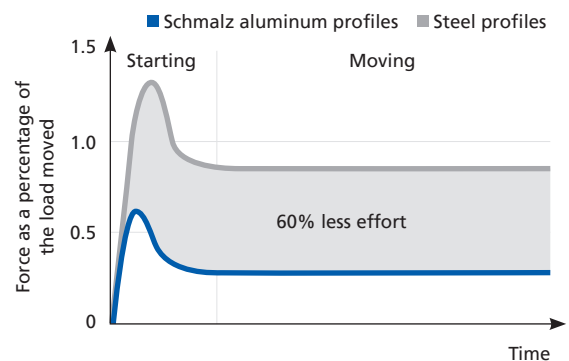

FLEXIBLE MODULAR SYSTEM

- Optimal adjustments to individual requirements
- Modularity enables flexible expansion and retrofitting
- Reduced number of parts
- Extensive accessories



PROFESSIONAL PROJECT PLANNING

- Consultation and design provided by experienced system consultants
- Professional support thanks to project planning software and CAD data



QUICK DELIVERY AND INSTALLATION

- Short delivery times because everything is manufactured in house at Schmalz
- Fast and simple installation
- Upon request, we will take care of installation and external certification



SAFE INVESTMENT

- Tested system thanks to independent force calculations of all load bearing components according to the FEB method
- High-quality products that are "Made in Germany"



The Right Solution for any Task.

Whether receiving or dispatching goods, the assembly line or the workplace in the production hall – aluminum crane systems from Schmalz ensure an ergonomic and efficient flow of materials and goods in all areas of intralogistics. The responsive lifting devices have a modular design and can be easily integrated into any infrastructure.

Jib Cranes

Ergonomic Workplace Crane Solutions

Jib cranes from Schmalz improve the ergonomics when handling loads at the workplace. Different load classes as well as options for attachment to the floor, to walls or to existing pillars make a wide range of uses possible.



Aluminum wall mounted jib crane with chain hoist and magnet during loading of a milling machine



Aluminum column mounted jib crane with vacuum lifting device VacuMaster Comfort during loading of a CNC machining center



Aluminum column mounted jib crane with vacuum tube lifter JumboErgo during loading of a CNC machining center



Aluminum wall mounted jib crane, mounted to a production hall pillar, with vacuum tube lifter JumboSprint during handling of raw rubber bales

Overhead Crane Systems

Flexible Crane Solutions for Large Working Areas

Overhead crane systems from Schmalz are designed using standardized modular elements according to individual customer requirements. Whether monorail, single bridge or multi bridge crane systems – an optimal use of space is guaranteed.



Aluminum single bridge crane system with vacuum lifting device VacuMaster Basic during loading of a high rack storage system



Aluminum multi bridge crane system with reinforced section and chain hoist handling rolls of film



Aluminum single bridge crane system with reinforced section and chain hoist during machine loading



Aluminum single bridge crane system with vacuum tube lifter JumboErgo loading a CNC machine



Aluminum single bridge crane system with reinforced section and a conductor line used with a chain hoist and a magnet



Aluminum single bridge crane system with reinforced section and vacuum lifting device VacuMaster Window during handling of windows



Aluminum single bridge crane system with conductor line and vacuum lifting device VacuMaster Comfort destacking wall panels



Aluminum multi bridge crane system with vacuum tube lifters JumboFlex commissioning packages



Aluminum single bridge crane system with telescopic jib and vacuum lifting device VacuMaster Comfort handling plastic sheets



Aluminum crane system SRA with vacuum tube lifter Jumbo



Schmalz Crane Systems – The Easy Way.

Schmalz aluminum overhead crane systems offer impressive low friction operation. A favorable weight-load ratio ensures that even heavy work pieces are handled effortlessly. The equal distribution of loads on all the supporting rollers prevents the transport trolleys from tilting. The modular design allows the crane system to be attached to any steel structure or other superstructure.

Aluminum Overhead Crane Systems

Introduction

APPLICATION

- Modular crane system permitting the flexible and cost efficient configuration of individual crane solutions
- Suitable for use in almost any internal production, assembly, or logistics process for the manual or automatic handling of all types of loads
- Particularly suited to large work spaces
- Maximum load of up to 1,200 kg



Low ceiling mounted aluminum single bridge crane system with conductor line to accommodate the low ceiling height

DESIGN

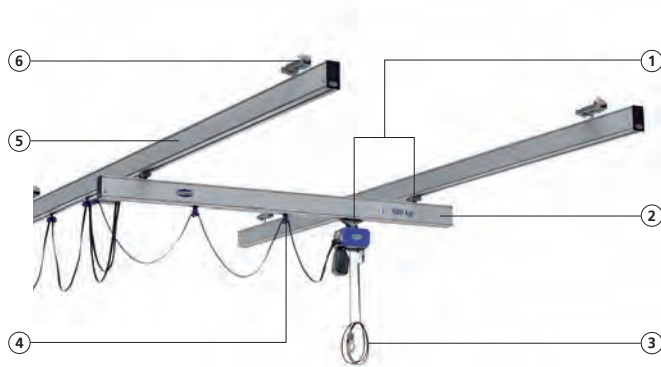

- ① **Transport trolley**
 - Connection of crane bridge and hoist
- ② **Aluminum crane bridge**
- ③ **Chain hoist** — p. 28
- ④ **Energy supply**
 - Trailing cable or conductor line
- ⑤ **Aluminum crane runway**
 - Lightweight and robust
 - Weights from 3 kg/m
- ⑥ **Modular ceiling suspension system**
 - Optimum connection to existing building structures

YOUR BENEFITS

- Ergonomic handling thanks to outstanding low friction operation and low moving mass
- Reduced processing times thanks to high speed operation and positioning accuracy
- Aligns to individual requirements in terms of budget and load capacity
- High reliability thanks to high quality, wear resistant components
- Maximum safety thanks to independent force calculations of all load bearing components according to the FEB method
- Easy mounting thanks to intelligent modular system
- Designed according to the state of the art (DIN EN13001-1:HC3/S1)

Aluminum Overhead Crane Systems

Innovative Basic Components

LIGHTWEIGHT AND ROBUST ALUMINUM SECTION

- Weight optimized extruded section with hollow chamber geometry (weight from 3 kg/m)
- Inner web for reinforced vertical support
- Material: Aluminum natural anodized (EN AW 60 63 T66)
- Five section sizes for loads weighing up to 1,200 kg
- Section lengths up to 8,000 mm can be extended as needed using rail connectors
- Dovetail for retroactive mounting of variable end stops

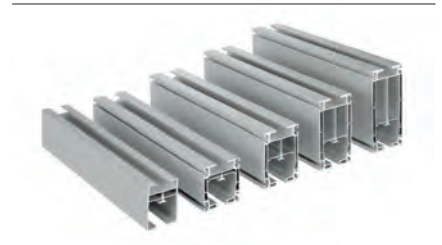

Aluminum sections SRA



End plate

- Attractive closing off of sections
- Protection from dirt



Reinforcement section

- Increases range and suspension distance by up to 50% while maintaining the same maximum load
- Increases the maximum load for installed crane systems



Rail connector

- Positive and non positive connection of sections for crane runways or bridges larger than 8,000 mm
- Full load capacity at the interface

High Load Capacity for Sections

The load diagram can be used for reference when selecting the section size while taking a specific maximum load and the suspension distances into account. The suspension distances stated are based on a deflection of 1:300, the common value for calculating crane systems. Smaller deflection values such as 1:400 may be required for certain applications.

Example: With a maximum load of 200 kg and a predetermined suspension distance of 5,000 mm the profile SRA-140 is used. The maximum deflection is then 17 mm (5,000 mm/300).

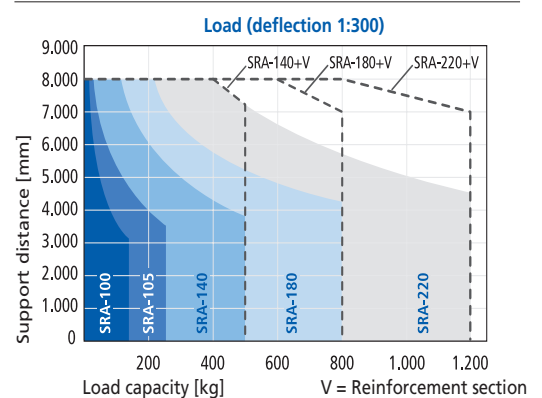

Type	Height [mm]	Weight [kg/m]	Max. lift capacity [kg]	Area moment of inertia [cm ⁴]		Moment of resistance [cm ³]	
				I _z	I _y	w _z	w _y
SRA-100	100	3.0	125	114	89	25	20
SRA-105	105	4.8	250	264	246	48	52
SRA-140	140	6.5	500	652	377	92	75
SRA-180	180	8.2	800	1,279	447	141	89
SRA-220	220	9.9	1,200	2,266	529	204	106
SRA-80-V*	80	4.0	-	177	143	-	-

*Reinforcement section suitable for SRA-105, SRA-140, SRA-180 and SRA-220

TRANSPORT TROLLEY WITH OPTIMAL RUNNING PERFORMANCE

- Stable aluminum pressure cast construction for loads weighing up to 1,000 kg
- Only one transport trolley required to connect the crane bridge and hoist; thus less parts
- Double transport trolley for loads weighing up to 1,200 kg
- Optimal running performance thanks to large rollers made from high performance plastic
- Upward and downward forces absorbed by only six rollers
- Optimized for low ceiling heights thanks to its compact size
- Eccentric pressure rollers to compensate vertical forces on telescopic jibs



Transport trolley

Type	Height [mm]	Length [mm]	Width [mm]	Weight [kg]	Max. lift capacity [kg]	
					Tension	Pressure
Transport trolley TRO-R-SRA-GAB-1000	125	240	55	1.4	1,000	1,000
Double transport trolley TRO-R-SRA-GAB-1200	150	500	75	6.5	1,200	1,200

ELECTRICAL TRACTION DRIVE

- Drive loads weighing up to 500 kg in overhead crane systems
- Suitable for all section sizes
- Quick movement and precise positioning thanks to two continuously adjustable driving speeds
- Low noise and vibration levels due to Soft Start and Soft Stop
- Adjustable travel path by means of a hub switch
- Very good grip thanks to a large surface drive wheel (no slip through)
- Optimal connection to Schmalz chain hoists thanks to current feed through



Electrical traction drive for hoist

Type	Max. drive load [kg]	Speed [m/min]	Weight [kg]	Max. power [kW]	Duty cycle [%]
① Hoist drive	800	0 - 40	19	0,25	60
② Crane bridge drive	800	0 - 40	34	0,5	60
③ Complete drive	800	0 - 40	53	0,75	60

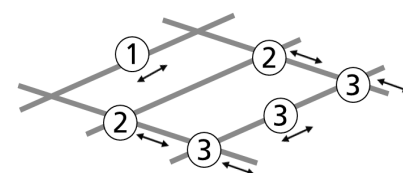

Aluminum Overhead Crane Systems

Innovative Basic Components



Crane bridge suspension element

- Maximum load 2,000 kg
- Swivel mounted as standard
- Easy replacement of the joint
- 90° design for standard crane bridge; 0° design for telescopic rails



Fixed end stops

- Prevents transport trolleys from falling out
- Positive locking for maximum safety
- Tool free mounting



Variable end stops

- Easy adjustment of the crane bridge and hoist travel path
- Demarcation of several working areas and the cable storage device
- Can be mounted at a later stage



Antishock end stops

- Gentle stopping of transport trolleys if end stops have to be reached e.g. for dynamic applications and telescopic jibs

FURTHER COMPONENTS FOR INDIVIDUAL REQUIREMENTS



Distance connectors

- Reinforcement for the design of double bridge crane systems
- Available for all section sizes

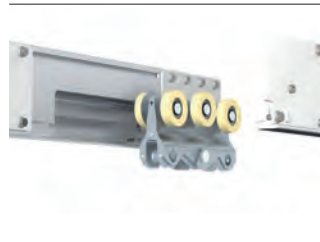

Service station

- Easy replacement of transport trolleys, particularly for long crane systems and for crane systems with several crane bridges
- Available for all section sizes



Low headroom module

- Raises crane bridge to the level of the crane runway
- Reduces the overall height of crane systems for low ceiling heights or transit roads



Spring return for telescopic jib including damping

- Returns telescopic jibs after reaching into difficult to access areas
- Optimal work flow thanks to the independent return of the jib

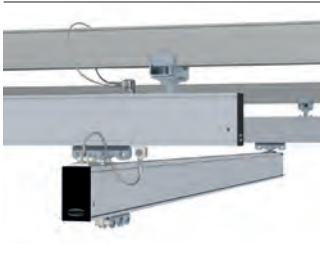

Safety cables

- Further secures crane bridges, crane runways and hoists by means of steel cables

Modular Ceiling Suspension System

The modular ceiling suspension system offers a wide range of options for connecting crane systems to existing building structures. An additional superstructure does not need to be used.

- Standard widths 50 – 150 mm, 150 – 250 mm and 250 – 310 mm
- Max. lift capacity 2,000 kg

STANDARD SUSPENSION FOR I-BEAMS AND T-BEAMS

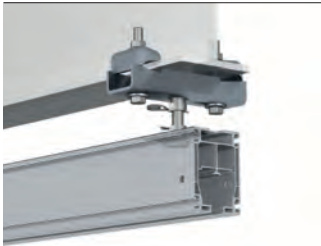

Suspended, height-adjustable

- Compensation of height differences in the ceiling structure by up to 30 mm

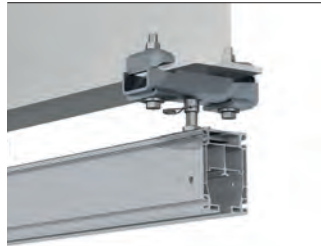

Rigid, height-adjustable

- Absorption of upward forces for telescopes, lifting axes or manipulators

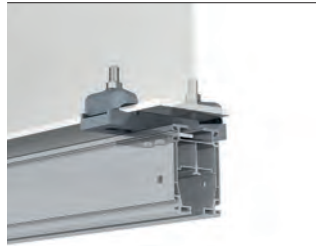

Rigid short 0°

- Reduction of the overall height for low ceiling heights

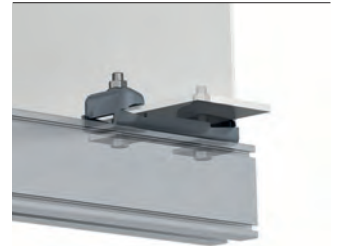

Rigid short 90°

- 90° rotated design to reduce the overall height for low ceiling heights

SUSPENSIONS FOR CONCRETE CEILINGS, WOODEN GIRDERS AND LAMINATED BEAMS



Anchor plates for concrete ceilings

- Special high-performance anchors with approval for dynamic loading
- Required concrete quality C20/C25, concrete thickness min. 190 mm



Clasp for wooden girders and laminated beams

- Safe mounting on wooden girders and laminated beams

EXPANSION OPTIONS



Extension by up to 2,000 mm

- Extension of the suspension to max. 2,000 mm for high ceilings
- Diagonal brace required for stabilization



Diagonal suspension

- Connection for ceiling structures with inclines greater than 8°
- Diagonal brace required for stabilization

Aluminum Overhead Crane Systems

Safe and Functional Energy Supply

CONDUCTOR LINE

- Wireless energy supply for electrical devices supplied in the crane such as the chain hoist or vacuum lifting device
- Profit from usable ceiling height as there are no cable storage devices or cable loops to cause interference
- Ideal for crane systems with several bridges
- Low surplus loading of the crane system thanks to lightweight plastic rails
- Easy mounting thanks to adapted suspensions and spring loaded connectors for copper contacts



Crane system with conductor line to supply a chain hoist

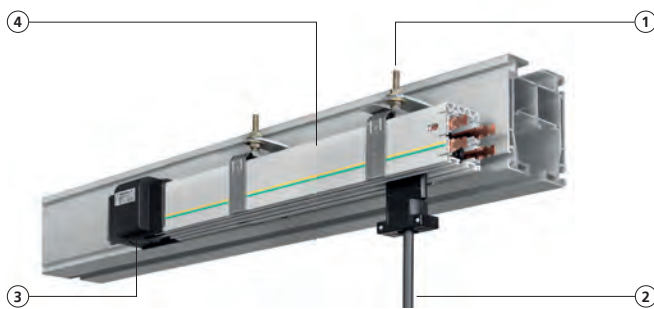

- 1 Sliding and fixed suspension**
 - Compensation of temperature related length elongation
- 2 Current collector made of impact-resistant plastic**
 - Safe current transmission thanks to spring loaded brushes
 - No possibility of mixing up poles thanks to coded housing
 - Can be moved easily thanks to ball bearing rollers
- 3 Connector with main supply**
 - Circuits or end feeds possible
- 4 Plastic housing**
 - Compact and resistant to corrosion

Technical information	Conductor line SCL
Length	5 standard lengths of 500 mm to 4,000 mm (can be expanded as needed)
Number of poles	4-pole
Max. rated currents	40 A for 100% duty cycle; 52 A for 60% duty cycle
Ambient temperatures	-30 °C to +60 °C
Flammability	Difficult to ignite (DIN 4102-1 class B1)
Protection rating	IP 23
Certification	UL certified

TRAILING CABLE

- Most common form of energy supply via cable trolleys in the aluminum section
- Suitable for power cables (flat cables) and hoses (vacuum and compressed air)
- Easy mounting thanks to pre-assembled cable trolley

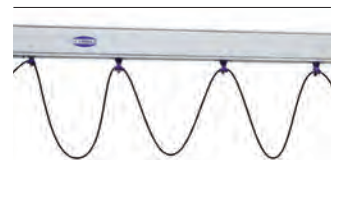

Configuration Examples



Monorail Crane System

- Cost efficient crane solution for easy transportation of loads along an axis
- Low overall height

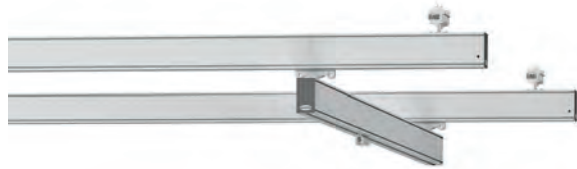

Single Bridge Crane System

- Standard solution for comprehensive transportation of loads along two axes
- Optimal use of space



Multiple Bridge Crane System

- For operation of several hoists on a crane system (example: in shipping departments or on assembly lines with several work places)



Single Bridge Crane System with Telescopic Jib

- Enables access to production spaces that are difficult to reach (example: loading CNC machines)



Low Headroom Single Bridge Crane System

- Optimal use of the ceiling height available

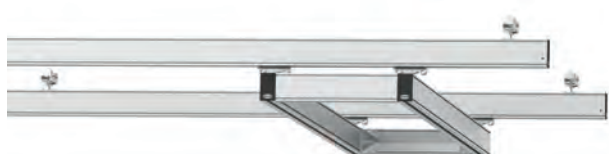

Double Bridge Crane System

- For connecting rigid lifting systems, such as manipulators or load axles
- Even load distribution



Flexible and Safe Steel Structure.

With the modular crane gantry KBG, Schmalz complements its product portfolio in the field of crane systems. Customers benefit from a uniform and safe connection of the aluminum overhead crane system SRA, which is optimally integrated into the overall handling system. An installation can be extended in length as required, thus ensuring flexibility for future requirements.

Modular Crane Gantry KBG

Introduction

APPLICATION

- Modular crane gantry for flexible assembly of individual crane solutions in connection with the Schmalz aluminum overhead crane system SRA
- Modular crane gantry for use in almost all internal production, assembly and logistics processes
- Connection of the Schmalz aluminum overhead crane system SRA, if it cannot be suspended from the ceiling
- Any extension of the system in length possible
- Maximum lift capacity approx. 500 kg (workpiece weight and dead weight of lifting device)



Modular crane gantry KBG with vacuum tube lifter JumboFlex for handling medium-sized cardboard boxes

DESIGN

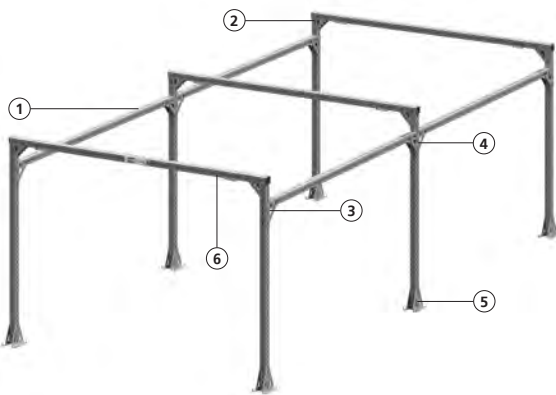

- ① **Self-developed rolled profile**
140 x 140 x 4 mm, with perforations for connecting the connecting plates
- ② **Schraubengarnitur**
for connecting the components to the profile
- ③ **Corner plate**
for connecting cross and longitudinal beam to the pillar (longitudinal beam is required for higher loads)
- ④ **T-plate**
for connecting pillar and longitudinal beam
- ⑤ **Base plate**
for fastening the pillar to the floor by means of dynamic plugs
- ⑥ **Suspension plate**
for attaching the Schmalz aluminum overhead crane system

PRODUCT HIGHLIGHTS

- Few components and modular design allow fast processing and short delivery times
- Flexible integration into the existing production layout as well as easy adaptation and expansion in case of later change
- Easy installation and assembly due to the screw set and the intelligent modular system
- High level of safety thanks to independent strength calculation of the load-bearing components using the FEM method (designed in accordance with DIN EN 13001: HC3/S1)
- Robust surface protection due to the galvanized profile surface

Modular Crane Gantry KBG

Modular elements



Portal profile

- In-house developed, hot dip galvanized rolled profile
- Rastering in steps of 100 mm
- Use for pillars, cross and longitudinal beams
- Perforations for connecting plates with screw set



Screw set

- Connection of all connecting plates to the profile
- Simple mounting of the connecting plates on the profile



Corner connection

- Connection of pillar and cross beams
- Connection of pillar and longitudinal beam at the first and last gate



Foot plate

- Connection to the profile on both sides with two screw sets each
- Alignment of the pillar with adjusting screws
- Anchoring to the floor with two plugs per foot plate



Base plate

- Base plate is inserted between the foot plates
- Profile lies flat on the base plate



Suspension plate

- Connection to the profile on both sides with two screw sets each
- Connection of the overhead crane system with standard suspension for I-beams and T-beams (rigid and pendulum)



T-connection plate

- Connection of two longitudinal beams to one pillar
- Connection to the profile on both sides with six screw sets each



Cover cap

- Cover of the ends of the cross beams
- Visually appealing finish of the profile



Cable protection

- Protection of the cable during entry and exit from the profile

Accessories and Configuration Examples



Collision protection

- Protection against collision with the gantry pillar



Blower console

- Direct mounting of the blower console to the profile with two screw sets
- The screw sets are included in the set



Crane gantry without longitudinal beam

- Standard solution for low payloads up to approx. 200 kg



Crane portal with longitudinal beam

- Standard solution for high payloads of up to approx. 500 kg



Smallest crane gantry with SRA crane system

- Smallest configuration option of the KBG for small sites



Larger crane gantry with SRA crane system and JumboFlex

- Example configuration of a crane gantry with two crane girders and tube lifters JumboFlex



Aluminum Jib Cranes – Easier Done Than Said.

Jib cranes from Schmalz are very versatile and can be combined with many lifting devices such as chain hoists, rope hoists, rope balancers or vacuum lifting devices. They boast perfect ease of movement and ergonomic operation. As a result of the high load capacity of up to 1,000 kg, heavy workpieces can also be lifted safely and with little physical effort.

Aluminum Jib Cranes

Introduction

APPLICATION

- Ergonomic and safe transport of all types of load at the work place
- Use in combination with hoists such as chain hoists, rope hoists, rope balancers or vacuum lifting devices
- Flexible integration thanks to column or wall mounting
- Maximum load of up to 1,000 kg



Wall mounted jib crane with vacuum tube lifter Jumbo

DESIGN

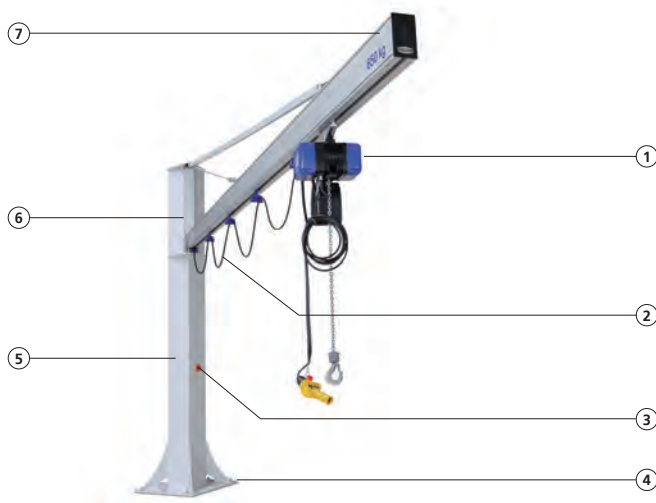

- ① **Chain hoist** — p. 28
- ② **Energy supply**
Trailing cable or conductor line
- ③ **Motor protection switch**
can be integrated
- ④ **Anchor-ready base plate**
Dimensions: 400 x 400 mm to 950 x 950 mm
- ⑤ **Coated steel crane column**
 - Overall height: 5,250 mm
 - Lower edge of jib: max. 4,000 mm
 - Alternatively with console for wall mounting
- ⑥ **Aluminum pivot bearing**
 - Column mounted jib crane swivel angle: 270°
 - Wall mounted jib crane swivel angle: 180°
 - Can be limited
- ⑦ **Aluminum jib**
Length: 2,000 mm to 8,000 mm

YOUR BENEFITS

- Outstanding low friction operation thanks to low moving mass
- High speed operation and positioning accuracy
- Supports ergonomic operation while reducing strain on workers
- Large operating range thanks to generous swivel angle
- Adjustable travel path thanks to variable end stops
- High quality wear resistant components
- Modern design with anodized surfaces
- Designed in accordance with DIN EN13001-1:HC3/S1

Aluminum Jib Cranes

Innovative Basic Components

ALUMINUM JIB MINIMIZES THE FORCE REQUIRED

- Optimal low friction operation thanks to extruded section with hollow chamber geometry
- Material: Aluminum natural anodized (EN AW 60 63 T66)
- Easy swiveling thanks to low mass (weight from 3 kg/m)
- Easy jib alignment for exact positioning of the load
- In each case, two fixed and variable end stops for adjusting the travel path are included



Aluminium jib

HIGH LEVEL OF ERGONOMICS DUE TO PERFECT EASE OF MOVEMENT



Easy to move pivot bearing

- Effortless swiveling even close to the pivot bearing
- Easy mounting even when the ceiling height is low thanks to two separate bearing bolts
- Maintenance free spherical bearing



Low friction transport trolley

- Sturdy pressure cast aluminum design
- Secure connection of all types of hoists
- Optimal running performance thanks to large rollers made from high performance plastic

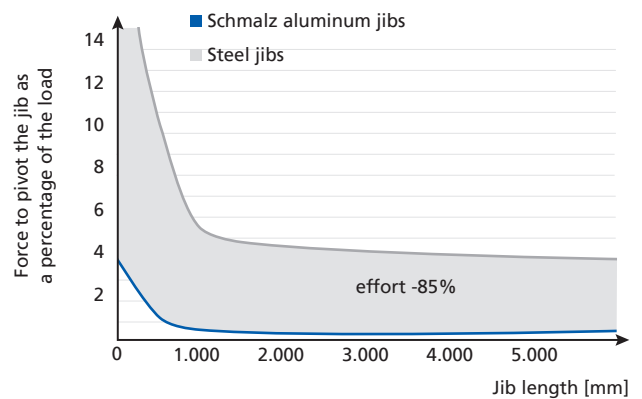

Force to pivot the jib of Schmalz aluminum jib cranes compared to conventional steel jib cranes

SAFE AND FUNCTIONAL ENERGY SUPPLY

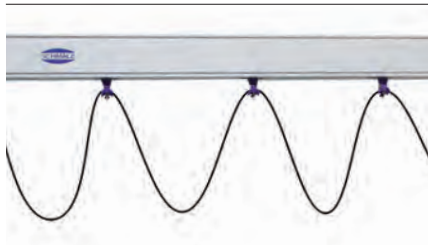

Trailing cable

- Standard energy supply via cable trolley in the aluminum section
- Suitable for power cables (flat cables) and hoses (vacuum and compressed air)



Cable carrier V-Chain

- Packs the hose package of the hose lifter JumboFlex in a space-saving way – no need for cable loops underneath the crane jib
- Up to 750 mm of extra usable space underneath the jib



Conductor line

- Wireless power supply via insulated plastic rails
- No cable storage devices or cable loops to cause interference
- Travel path between pivot bearing and transport trolley up to 400 mm larger

Attachment and Accessories

ATTACHMENT FOR COLUMN MOUNTED JIB CRANES



Crane column

- High quality welded steel construction, RAL 7035 light gray coating (special coating upon request)
- Fitted with anchors
- Space-saving dimensions of the base plate (400 x 400 mm to 950 x 950 mm)



Anchor set

- High quality injection mortar anchor
- No additional foundation necessary
- For loads weighing up to 1,000 kg



Anchor bolts

- Use when concrete quality is low
- Dimensions of the foundations from 1,300 x 1,300 mm to 2,300 x 2,300 mm
- For loads weighing up to 1,000 kg



Mobile base plate

- No need to attach to the floor
- Can be easily transported by means of a forklift or pallet truck
- Dimensions from 1,200 x 1,200 mm to 1,470 x 1,470 mm
- For loads weighing up to 200 kg (depending on the jib length)

ATTACHMENT FOR WALL MOUNTED JIB CRANES



Wall bracket

- Steel console, RAL 7035 light gray coating (special coating upon request)



Clasp bracket

- For mounting the wall bracket to an existing production hall pillar or column



Anchor set

- High quality injection mortar anchor for attachment to walls
- For loads up to 110 kg (depending on the jib length)



Counter plate

- Counter plate with clearance holes for attachment to walls

ACCESSORIES



Slewing angle limiter

- Limit stop for individual adjustment of the swiveling range by 0° to 120° per swivel side
- Optional process monitoring



Blower console

- For attaching vacuum generators directly to the crane column
- Easy mounting by means of a clasp



Integrated motor protection switch

- To protect electrical devices against overvoltage
- Can be locked, optional and therefore suitable as main switch

Aluminum Jib Cranes

Technical Data

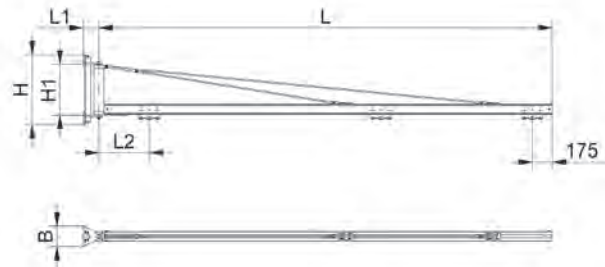
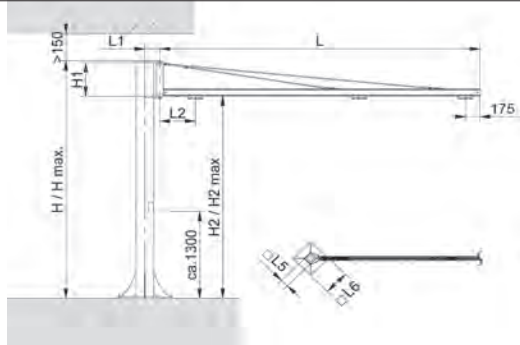

Column mounted jib crane SK

Wall mounted jib crane WK

Type	Max. lift capacity [kg]	L [mm]	H* [mm]	H1 [mm]	H2** [mm]	B [mm]	L1 [mm]	L2 [mm]	L5 [mm]	L6 [mm]
SK-KZG-80	80	3.000 – 6.000	3.130	500	2.600	–	182	600 – 800	140 – 180	400
SK-KZG-125	125	3.000 – 6.000	3.130 – 3.380	500 – 750	2.600	–	210	600 – 800	180	400 – 550
SK-KZG-200	200	3.000 – 8.000	3.380	750	2.600	–	210 – 260	650 – 850	180 – 250	550 – 700
SK-KZG-350	350	3.000 – 6.000	3.385	750	2.600	–	260 – 290	650 – 850	250 – 300	700 – 860
SK-KZG-650	650	3.000 – 6.000	3.635	1.000	2.600	–	280 – 350	700 – 900	300 – 350	860
SK-KZG-1000	1.000	3.000 – 6.000	3.950	1.300	2.600	–	400 – 420	750 – 950	400 – 420	950
WK-KZG-80	80	3.000 – 6.000	695	500	–	205	155	650 – 850	–	–
WK-KZG-125	125	3.000 – 6.000	695 – 945	500 – 750	–	205	155	650 – 850	–	–
WK-KZG-200	200	3.000 – 8.000	945	750	–	250	155	700 – 900	–	–
WK-KZG-350	350	3.000 – 6.000	945	750	–	250	155	700 – 900	–	–
WK-KZG-650	650	3.000 – 6.000	1.195	1.000	–	400	155	750 – 950	–	–
WK-KZG-1000	1.000	3.000 – 6.000	1.495	1.300	–	600	155	800 – 1.000	–	–

*H max = 5,000 mm **H2 max = 4,000 mm

JIB CRANES ESPECIALLY FOR VACUUM TUBE LIFTER JUMBO

Only use in combination with the vacuum tube lifter Jumbo from Schmalz. The load classes correspond to the nominal lift capacities of the tube lifter. The weights of the tube lifters have already been accounted for.

Type	Max. lift capacity [kg]	L [mm]	H* [mm]	H1 [mm]	H2** [mm]	B [mm]	L1 [mm]	L2 [mm]	L5 [mm]	L6 [mm]
SK-JU-45	45	2.000 – 6.000	3.525	500 – 505	3.000	–	182	450 – 750	140	400
SK-JU-65	65	2.000 – 6.000	3.525 – 3.530	500	3.000	–	182 – 210	450 – 750	140 – 180	400
SK-JU-85	85	3.000 – 6.000	3.525 – 3.530	500	3.000	–	182 – 210	550 – 750	140 – 180	400
SK-JU-110	110	3.000 – 6.000	3.530	500	3.000	–	182 – 210	550 – 750	140 – 180	400 – 550
SK-JU-140	140	3.000 – 6.000	3.730 – 3.980	500 – 750	3.200	–	210	550 – 750	180	400 – 550
SK-JU-200	200	3.000 – 8.000	3.980	750	3.200	–	210	550 – 750	180	550 – 700
SK-JU-300	300	3.000 – 6.000	3.980 – 3.985	750	3.200	–	210 – 260	550 – 750	250	700 – 860
WK-JU-45	45	2.000 – 6.000	695	500 – 505	–	205	155	450 – 750	–	–
WK-JU-65	65	2.000 – 6.000	695	500	–	205	155	450 – 750	–	–
WK-JU-85	85	3.000 – 6.000	695	500	–	205	155	650 – 850	–	–
WK-JU-110	110	3.000 – 6.000	695	500	–	205	155	650 – 850	–	–
WK-JU-140	140	3.000 – 6.000	695 – 945	500 – 750	–	205 – 250	155	650 – 850	–	–
WK-JU-200	200	3.000 – 8.000	945	750	–	250	155	700 – 900	–	–
WK-JU-300	300	3.000 – 6.000	945	750	–	250	155	700 – 900	–	–

*H max for type SK...45-140 = 4,500 mm (4,750 mm for type SK...200/300) **H2 max for type SK = 4,000 mm

Jib Cranes for Special Areas of Application



ALUMINIUM FLAT JIB FOR PARTICULARLY LOW CEILING HEIGHTS

- Reduction in the overall height due to flat jib
- Modular jib length up to 5,000 mm
- For loads weighing up to 110 kg
- Base plate 400 x 400 mm
- Lower edge of jib up to 4,000 mm



ARTICULATED ARM JIB FOR CIRCUMVENTING INTERFERENCE CONTOURS

- Easy circumvention of obstacles such as pillars in production halls or machines thanks to the jib with additional joint
- Large usable ceiling height and avoidance of interference contours thanks to integrated vacuum line
- For loads weighing up to 85 kg
- Jib length of 3,000 mm and 4,000 mm
- Base plate 400 x 400 mm
- Lower edge of jib up to 4,000 mm



TELESCOPIC JIB FOR HARD TO ACCESS WORKING AREAS

- Jib lengths from 2,000 to 3,000 mm, 3,000 to 4,000 mm and 4,000 to 5,000 mm
- For loads weighing up to 85 kg
- Base plate 400 x 400 mm
- Lower edge of jib up to 4,000 mm

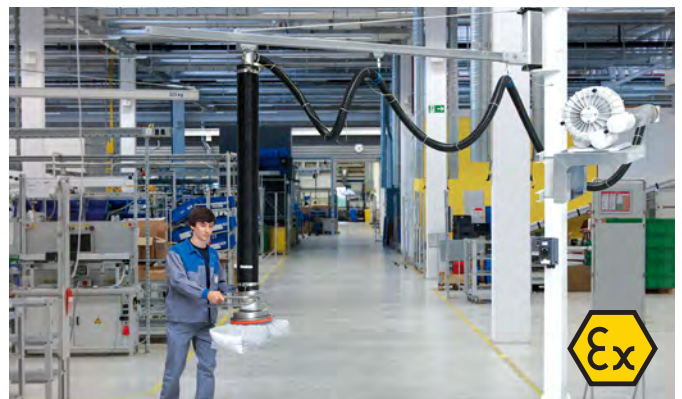

ATEX JIB CRANE FOR POTENTIALLY EXPLOSIVE ATMOSPHERES

- Suitable for explosion protection zones 1/2 and 21/22 in the chemical and pharmaceutical industry as well as in the food and beverage industry
- Crane rails made of steel
- Also available together with a flat jib or articulated arm jib
- For loads weighing up to 140 kg



Chain Hoists – Tough and Durable.

Chain hoists from Schmalz are reliable lifting aids in daily use. They meet the highest safety requirements thanks to the standard hoist limit switch, double sliding clutch and low control voltage of 42 V. High quality and low maintenance components ensure a long service life. The chain hoists are prepared according to your requirements and are completely assembled upon delivery.

Schmalz Chain Hoists

Powerful and Robust

APPLICATION

- Long lasting chain hoist with standard hoist limit switch for loads weighing up to 2,500 kg
- Plug & play connector means the chain hoist arrives ready to use
- Gear units are equipped with helical gearing, making them very responsive and quiet
- The low control voltage of 42 V and the emergency stop function ensure extremely safe operation
- CSA certified
- Standard lifting height of 3,000 mm; can be changed upon request
- Available with optional frequency control for smooth positioning



Schmalz Chain hoist SCH

OVERVIEW OF HIGHLIGHTS



Robust housing

- High-quality pressure-cast aluminum housing
- Optimal heat transmission thanks to molded cooling fins



Plug & play electrical connections

- Plug & play connections for all power connections
- Easy mounting without special tools
- Encoding to prevent faulty connections



Ergonomic controls

- Comes with strain relief for cables and emergency stop as standard
- Available in different lengths and with two or four control buttons



Guided chain

- No jamming thanks to two-part guide
- Wear-resistant chainsprocket made from hardened steel
- Longer service life due to phosphated profile steel chain



Double clutch

- Optimal protection thanks to dual principle of operation
- Easy to service
- Precise and easily adjustable (special tool required)



Maintenance free brake

- Maximum safety thanks to the brake being positioned behind the sliding clutch
- Maintenance free, modern DC magnetic brake



Robust motor for extreme application conditions

- Two-phase pole changing drive or with frequency inverter for infinitely variable speed control
- Very smooth running thanks to helical gearing
- Wear free thanks to permanent lubrication of the gearbox



Standard gear limit switch

- Easy adjustment of the lifting height
- High repeatability for exact positioning of the load



ONE-HAND OPERATION WITH THE HANDYLIFT

- Ergonomic rocker switch for left and right hand operation
- Chain hoist solution with mechanical load handling devices for a wide range of industrial products
- Comfortable one-hand operation for fast and precise positioning of the load



Excellent Support at Every Stage.

Put your trust in our global service network which offers comprehensive expert services relating to all areas of your crane system. Our specialists will support you from the consultation and project planning to the installation and regular maintenance. Dependable spare parts management completes our service offering.

Schmalz Services

Your Added Value from Planning to Implementation



Project Start up on Site

Our experienced system consultants in field sales will advise you on site and together you will find the optimum crane solution for your application.



System Design

The extensive expertise of our specialists and the use of innovative IT systems always ensures a safe and economic system design.

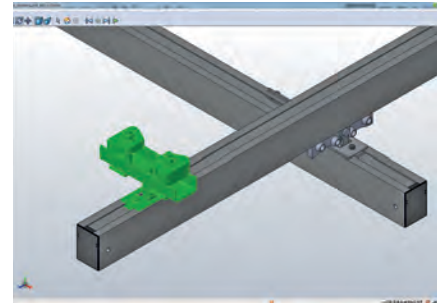

CAD Data and Planning Tool

Product data in 2D and 3D for the individual components facilitates project planning for system integrators and design offices.



Assembly and Start of Operations

Our experienced service technicians will take care of the complete assembly for you – including electrical connection and initial safety inspections in accordance with national regulations (e.g. in Germany BGR 500 and BGV D6).



Regular Safety Inspection

We will be happy to take care of the annual safety inspections in accordance with national regulations (e.g. in Germany BGR 500 and BGV D6). Benefit from our convenient service contracts.



Training and Operation

We provide training for your employees on site so that you can operate your crane system optimally. During ongoing operation, we promise to quickly and reliably provide you with replacement and wearing parts.



Warranty

When you choose Schmalz products, you're putting your trust in quality that's "Made in Germany". We offer a warranty for our crane systems. Should the need arise, we can quickly be on site anywhere in the world to provide you with further assistance.

Questionnaire Regarding the Design of Crane Systems

The First Step Towards Your Crane System

GENERAL SPECIFICATIONS

Which work piece is to be lifted?

What is the maximum weight of the work piece [kg]?

How much does the hoist weigh [kg]?

e.g. chain hoist, rope balancer, vacuum lifter

What kind of energy supply is needed?

- Current (trailing cable) Compressed air
 Current (conductor line) Vacuum

WORKING AREA

What coverage area is needed?

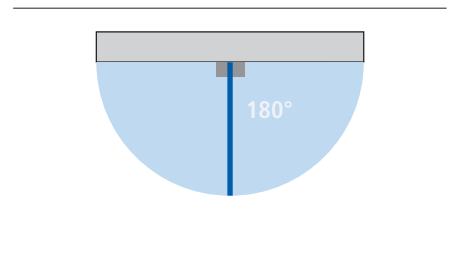
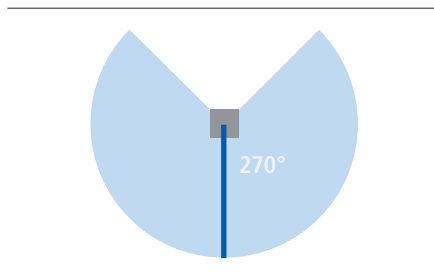
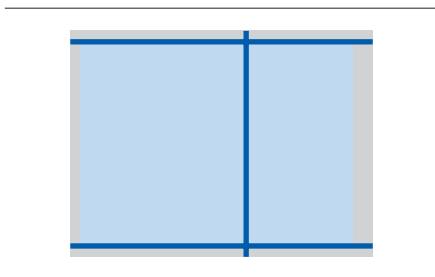

Overhead crane system

- Comprehensive transportation of loads, mainly in large working areas (configuration examples on p. 17)

Column mounted jib crane

- Circular working area (swivel angle 270°)

Wall mounted jib crane

- Semi circular working area (swivel angle 180°)

A. OVERHEAD CRANE SYSTEM

What is the size of the coverage area L x W [mm]?

What is the ceiling height [mm]?

Are multiple hoists operated on one crane system?

- No Yes, number

What type of crane attachment is possible?

- I/T-beams or portal
 Concrete ceiling (anchored)
 Wooden girders or laminated beams (clasp)

What suspension distances are specified [mm]?

e.g. distance between two I/T-beams

What obstacles need to be taken into account?

e.g. pillars in production halls, roof girders, pipes, light fixtures, cable bridges

B. JIB CRANES

What is the size of the coverage area [mm]?

Radius

Is a slewing angle limiter required?

e.g. in the event of interference from pillars in the production hall, pipes or cable bridges

No

Yes

What is the ceiling height [mm]?

What lifting height is required [mm]?

Lower edge of jib minus height of the hoist

What type of crane attachment is needed?

Column mounted jib crane

Anchored

With mobile base plate

Wall mounted jib crane

Concrete wall

Existing production hall pillar

SPACE FOR YOUR DRAWING

Do you need help filling out the questionnaire?

Our experts would be happy to assist you: Tel. +49 7443 2403-108, handlings-systems@schmalz.de

Ergonomic Vacuum Lifters from Schmalz

The Perfect Supplement to Your Crane System

VACUUM TUBE LIFTERS JUMBO

Whether cardboard boxes, crates, bags or wooden boards – the vacuum tube lifter Jumbo is the ideal helper for ergonomic handling of different goods in high cycle frequency. The intuitive operation allows you to move loads weighing up to 300 kg quickly, precisely and safely. Absences due to health problems are kept to a minimum while productivity increases at the same time.

WWW.SCHMALZ.COM/JUMBO



Vacuum tube lifter JumboFlex during commissioning of packages

VACUUM LIFTING DEVICES VACUMASTER

The vacuum lifting device VacuMaster from Schmalz is one tough guy. Whether metal plates, wooden boards, plastic sheets, barrels, windows or sheets of glass – the VacuMaster tackles even the heaviest tasks with weights up to several tons. For applications where many hands would normally be required, the VacuMaster allows work pieces to be handled effortlessly by just a single operator while protecting the employee's health.

WWW.SCHMALZ.COM/VACUMASTER



Vacuum lifting device VacuMaster Comfort during machine loading



SEE OUR VACUUM LIFTERS IN ACTION

The Schmalz Media Center will take you with few clicks to the application examples in your industry segment – user-friendly, informative and practical.

WWW.SCHMALZ.COM/VIDEO



Contact

Own Subsidiaries and Trade Partners in More Than 80 Countries

Our sales network of local field representatives, international subsidiaries and trade partners ensures quick and competent information and advice.

CANADA

Schmalz Vacuum Technology Ltd.
14-2900 Argentia Rd.
L5N 7X9 Mississauga; Ontario
T: +1 905 569 9520
F: +1 905 569 8256
schmalz@schmalz.ca

UNITED KINGDOM

Schmalz UK Limited
Unit 2 Woodrow Business Centre
Woodrow Way, Irlam
Manchester M44 6NN
T: (+44) 161 243 4642
schmalz@schmalz.co.uk

INDIA

Schmalz India Pvt. Ltd.
EL – 38 'J' Block MIDC
Bhosari
411026 Pune
T: +91 20 4072 5500
F: +91 20 4072 5588
schmalz@schmalz.co.in

UNITED STATES

Schmalz Inc.
5850 Oak Forest Drive
Raleigh, NC 27616
T: +1 919 713-0880
schmalz.us@schmalz.com

WORLDWIDE

Headquarters in Germany
J. Schmalz GmbH
Johannes-Schmalz-Str.1
72293 Glatten
T: +49 7443 2403-0
schmalz@schmalz.de

You can find contact information for
our trade partners in 80 countries at
WWW.SCHMALZ.COM/SALESNETWORK



The Schmalz Group – Worldwide On Site

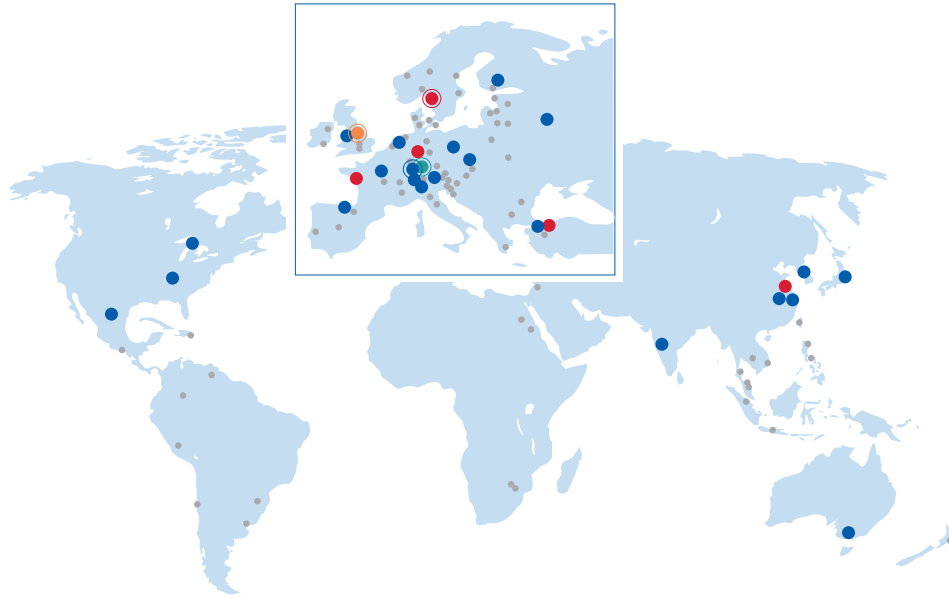

● Germany – Glatten

● International companies:

Australia – Melbourne
 Austria – Pasching
 Benelux – Hengelo (NL)
 Canada – Mississauga
 China – Shanghai
 China – Taicang
 Czech Republic – Hranice
 Finland – Vantaa
 France – Champs-sur-Marne
 India – Pune
 Italy – Galliate (NO)

● Sales partners

Japan – Yokohama
 Mexico – Querétaro
 Poland – Komorniki (Poznan)
 Russia – Moscow
 South Korea – Anyang
 Spain – Erandio (Vizcaya)
 Switzerland – Nürensdorf
 Türkiye – Istanbul
 United Kingdom – Manchester
 USA – Raleigh (NC)

BINAR HANDLING

● Sweden – Trollhättan

● International companies:

China – Shanghai
 France – La Haie-Fouassière
 Germany – Staufenberg
 Türkiye – Ataşehir-Istanbul

 Palamatic

● United Kingdom – Chesterfield

GPS GESELLSCHAFT FÜR
PRODUKTIONSSYSTEME

● Germany – Stuttgart

Vacuum Automation

WWW.SCHMALZ.COM/AUTOMATION

Handling Systems

WWW.SCHMALZ.COM/HANDLING-SYSTEMS

J. Schmalz GmbH

Johannes-Schmalz-Str. 1
 72293 Glatten, Germany
 T: +49 7443 2403-0
 schmalz@schmalz.de
 WWW.SCHMALZ.COM



schmalz.vacuumentechology



schmalz_group



schmalzmediacenter



schmalz



j-schmalzgmbh



schmalz_de