



**WBT**

# WBT



**WBT** è un'azienda che offre la freschezza di una mentalità giovane e propositiva, unita alla solidità garantita da oltre trent'anni di esperienza maturata su impianti dislocati in varie parti del mondo, distinguendosi per la competenza nel lavoro svolto e l'efficienza dei prodotti.

Il punto di forza principale della WBT è il reparto produttivo. La mente è formata da un gruppo di ingegneri che vantano anni di lavoro nel settore della progettazione di nastri trasportatori. Il braccio è costituito da operai specializzati, in grado di essere un valore aggiunto prezioso.

La competenza del reparto produttivo, unita all'utilizzo dei migliori materiali, rende i nastri trasportatori prodotti da WBT dei veri e propri prodotti di altissima finitura, realizzati in maniera rapida e impeccabile.

WBT è un'azienda che mira all'eccellenza, come possono confermare alcune tra le migliori aziende italiane che operano principalmente nel settore alimentare, vetrario, meccanico e del trattamento termico dei metalli.

***WBT** is a company that offers the freshness of a "can do, will do" attitude based on its young age combined with the solidity of more than 30 years of experience acquired on plants throughout the world. It stands out for its expertise and for the efficiency of its products.*

*The main strength of WBT is its production department. The mind consists of a group of engineers having years of expertise in designing conveyors belts. The arm consists of specialist workers, capable of being a precious added value.*

*The expertise of the production department and the use of the best materials make WBT's conveyor belts very high quality goods, manufactured rapidly and flawlessly.*

*WBT is a company that aims to excellence, as many between the best italian companies operating primarily in the food, glass, mechanical and metal heat treatment industry can confirm.*

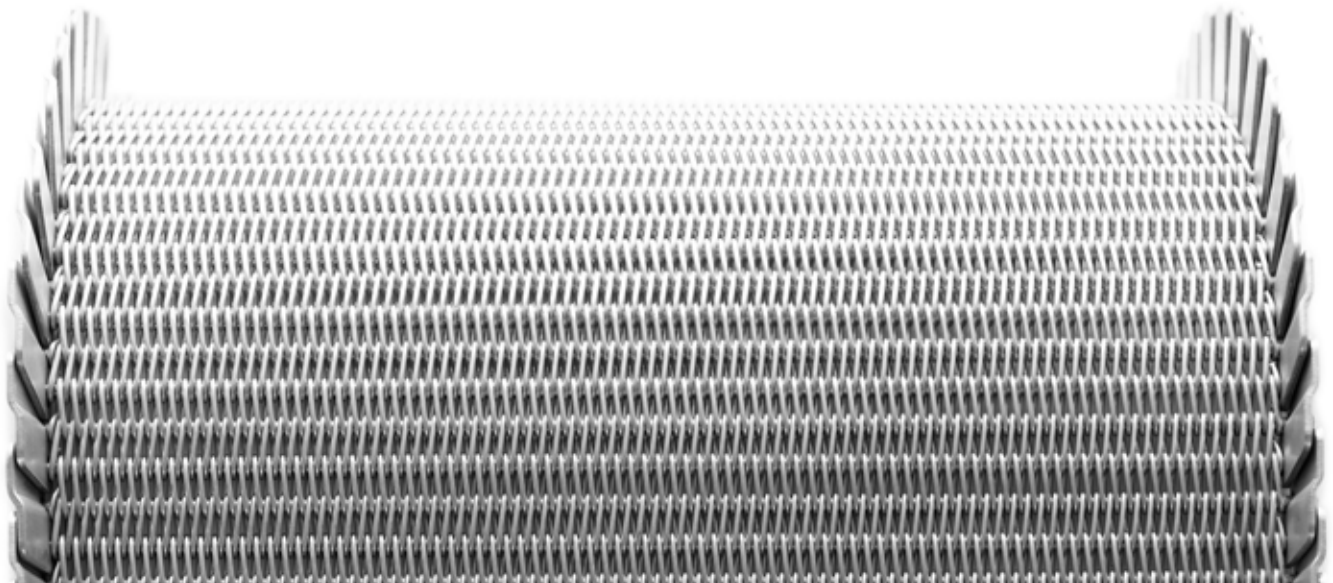



# WBT FMC



Nastro a maglia aperta fino ad un massimo dell' 85% formato da fili sagomati e innestati tra loro. Di facile pulizia e sanificazione, l'elevata flessibilità gli consente di avvolgersi su diametri molto piccoli. Trazione ad ingranaggi per un moto lineare e continuo senza sbandamenti anche alle alte velocità.

**WBT FMCD** Mantenendo le caratteristiche di WBT FMC, prevede una seconda catenella laterale di rinforzo.

*Open mesh belt, up to a maximum of 85%, formed by shaped and intertwined wires. Easy to clean and to sanitize, its high flexibility allows looping around very small diameters. Its traction sprockets allows linear and continuous motion, even at high speeds.*

**WBT FMCD** with the same characteristics as WBT FMC, but includes a second side chain for external reinforcement.

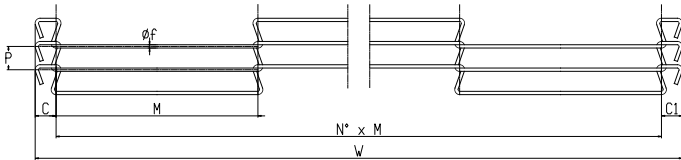

# WBT GP



Nastro a maglia aperta costituito da greche in piattina connesse tra loro da barrette dritte e trainato da ruote dentate. Particolarmente adatto nei processi di lavaggio, cottura, raffreddamento, trasferimento prodotti, asciugatura e trattamento delle acque.

*Open grid belt made of flat wire strips connected to each other by straight rods and pulled by sprockets. Suitable for cleaning processes, cooking, cooling, products transfers, drying and water treatment.*

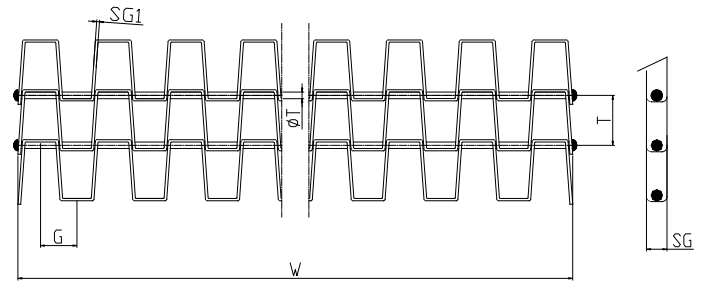

# WBT FMCD

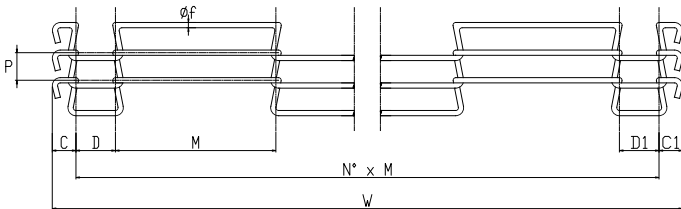

# WBT GO/GOP/GOC

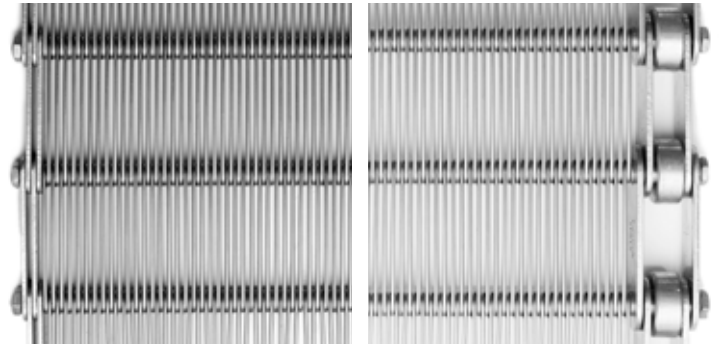

Nastro modulare ad apertura costante formato da graffette montate appaiate e connesse tra loro da barrette dritte. Facile pulizia e sanificazione. Semplice installazione e manutenzione.

**WBT GOC.** Nastro WBT GO, munito di catene laterali.

**WBT GOP.** Nastro WBT GO, sostituisce le graffette con piastrine.

*Modular belt with constant opening formed by eye links mounted in pairs and interconnected by straight rods. Easy to clean and to sanitize. Easy to install and to maintain.*

**WBT GOC.** Belt WBT GO with lateral chains.

**WBT GOP.** Belt WBT GO where the eye links are replaced by small plates.

# WBT RM

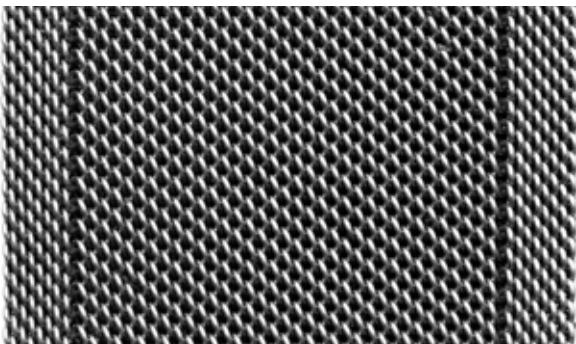

Nastro formato da spirali concatenate utilizzato prevalentemente nel trattamento termico dell'industria orafa.

*Belt made by intertwined spirals primarily used in the heat treatment of the jewelry industry.*

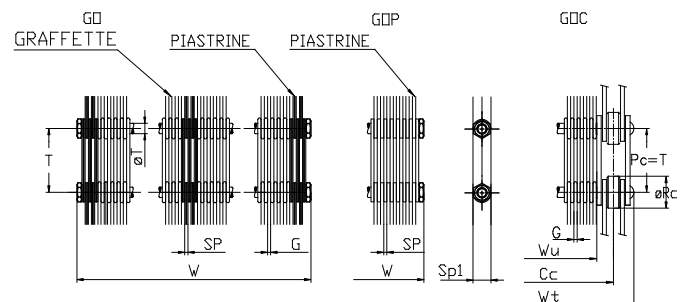

## WBT SA

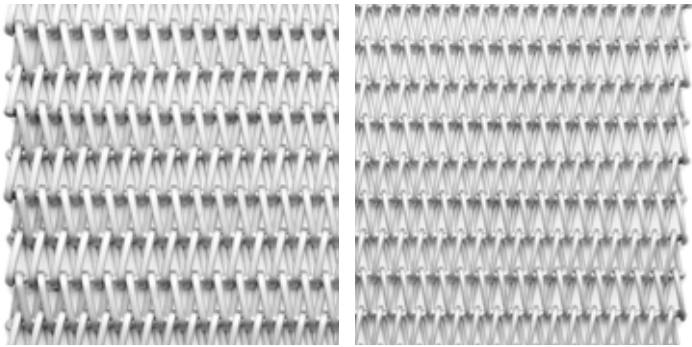

Nastro bilanciato costituito da spirali a torsione destra e sinistra montate alternate, connesse tra loro da barrette ondulate. Versatile, viene impiegato nella maggior parte dei processi industriali sia a freddo che ad alte temperature. Lineare e stabile in utilizzo, ottimo rapporto forza-peso, facile installazione e manutenzione.

*Balanced belt made by alternated right and left twist spirals, interconnected by corrugated bars. It is used in most industrial processes, cold ones as well as high temperatures ones. Linear and stable at usage, optimum ratio between force and weight, easy to install and to maintain.*

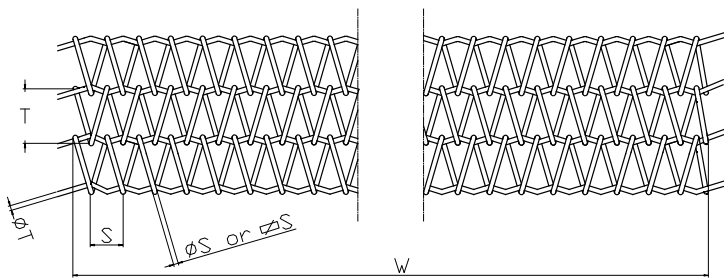

## WBT SDA

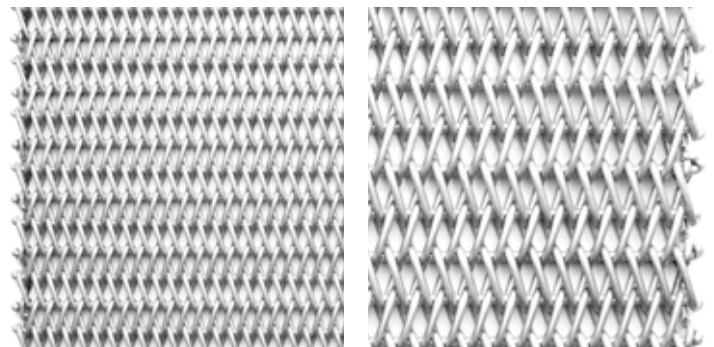

Nastro bilanciato costituito da spirali doppie a torsione destra e sinistra montate alternate e connesse tra loro da barrette ondulate o dritte. Impiegato in forni continui per il trattamento termico dei metalli per la sua resistenza alle sollecitazioni e il ridotto allungamento.

*Balanced belt made by alternated right and left double twist spirals, interconnected by corrugated bars. Used in continuous furnaces for heat treatment of metals because of its resistance to stress and to its low elongation.*

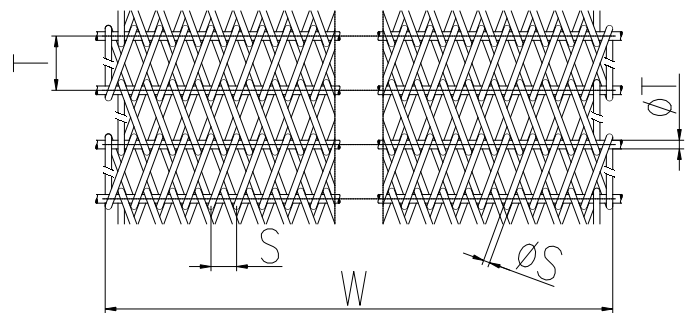

## WBT SAC

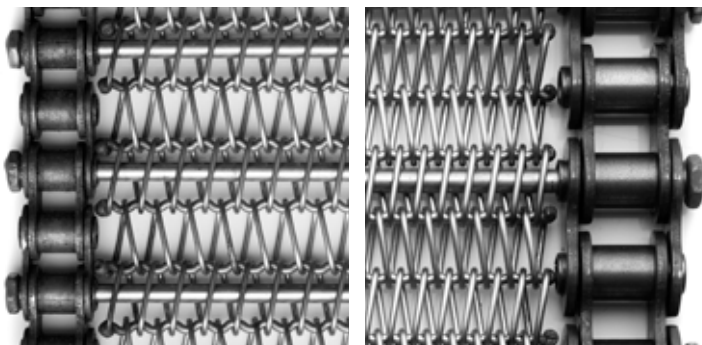

Nastro con le medesime caratteristiche di WBT SA, munito di catene laterali e, all'occorrenza, di spondine mobili.

*Belt with the same characteristics as WBT SA, with lateral chains and, if needed, mobile side edges.*

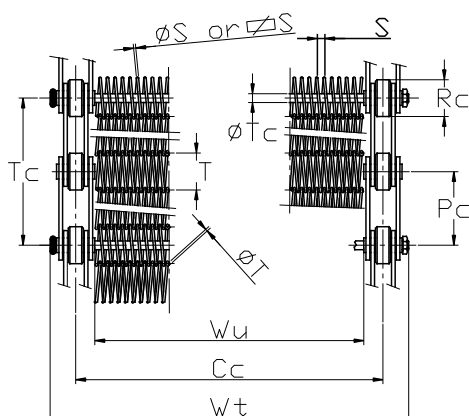

## WBT SDD

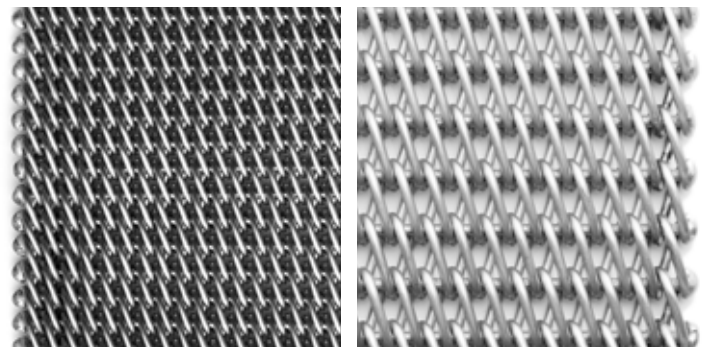

Nastro costituito da spirali monotorsione, doppie concatenate, e rinforzato dall'inserimento di barrette dritte. E' il nastro ideale per l'utilizzo gravoso a temperature fino a 1150° e per questo utilizzato in forni a tunnel per il trattamento termico di particolari metallici pesanti

*Belt made by single twist spirals double concatenated and reinforced with the insertion of straight bars. It is the ideal belt for high usage at temperatures up to 1150°C and is used in tunnel furnaces for heat treatment of heavy metal parts.*

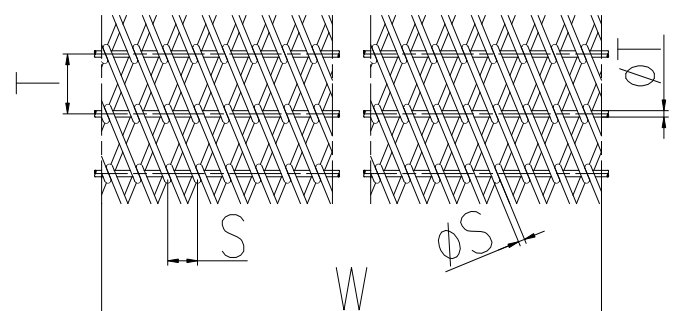

# WBT SF

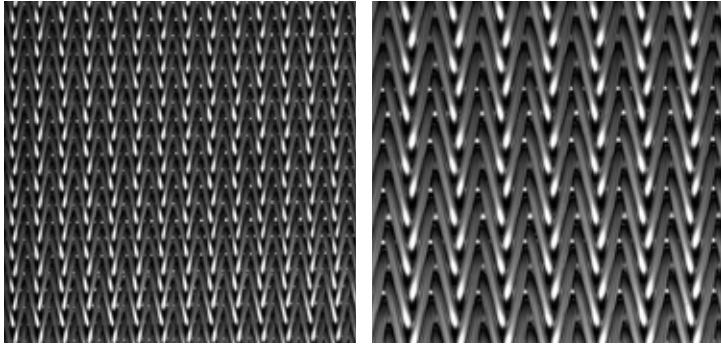

Nastro bilanciato a maglia fitta costituito da spirali a torsione destra e sinistra montate alternate e connesse tra loro mediante tre o più barrette. Adatto all'utilizzo in forni continui a tunnel per il trattamento termico di piccoli particolari fino alle temperatura di 1150°. Distribuisce uniformemente il calore, consigliato nel settore bakery.

*Balanced fine mesh belt made by right and left twist spirals, alternate mounted and interconnected by three or more bars. Suitable for use in continuous tunnel furnaces for heat treatment of small pieces up to temperatures of 1150°C. It distributes the heat uniformly, and therefore it is recommended for the bakery field.*

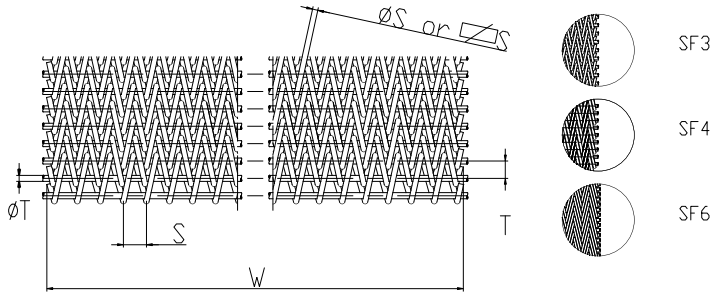

# WBT SC

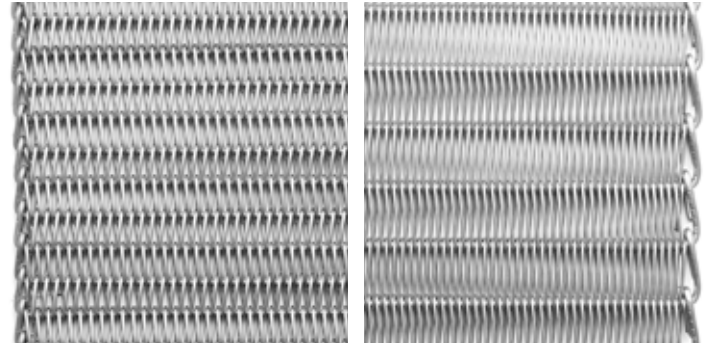

Nastro bilanciato costituito da spirali a torsione destra e sinistra montate alternate e connesse tra loro da barrette dritte. Perfetto per trasportare particolari anche di piccole dimensioni senza compromettere il passaggio dell'aria. Adatto all'utilizzo a freddo, viene impiegato maggiormente in forni continui a tunnel sia nel settore alimentare che nel metallurgico, fino a temperature di 1150°.

*Balanced belt made by right and left twist spirals, alternate mounted and interconnected by straight bars. Perfect for transportation of pieces, even small ones, without compromising the passage of air. Suitable also for cold usage, it is mostly used in continuous tunnel furnaces in the food applications as well as in the metallurgical ones, up to temperatures of 1150°C.*

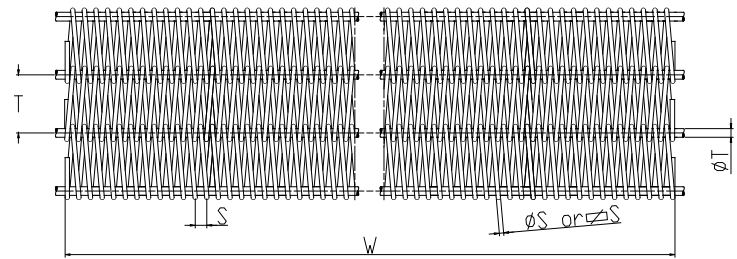

# WBT SFC

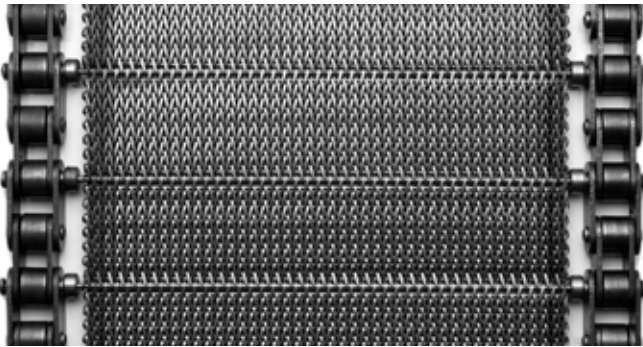

Nastro con le medesime caratteristiche di WBT SF, corredato di catene e all'occorrenza di spondine mobili e facchini di sollevamento.

*Belt with the same characteristics of WBT SF but complete with chains, mobile side plates and lifters.*

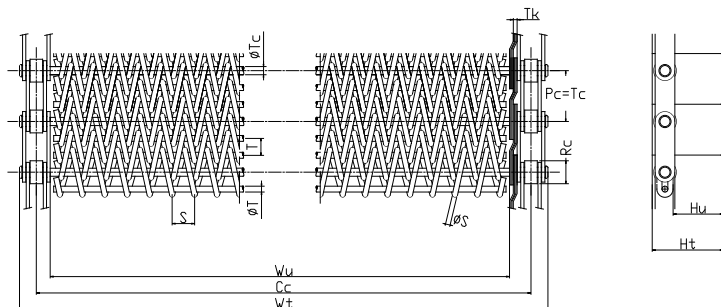

# WBT SCC

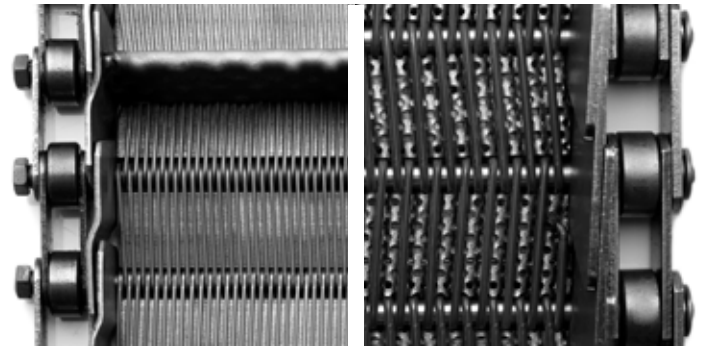

Nastro con le medesime caratteristiche di WBT SC, corredato di catene e all'occorrenza di spondine mobili e facchini di sollevamento.

*Belt with the same characteristics of WBT SC but complete with chains, mobile side plates and lifters.*

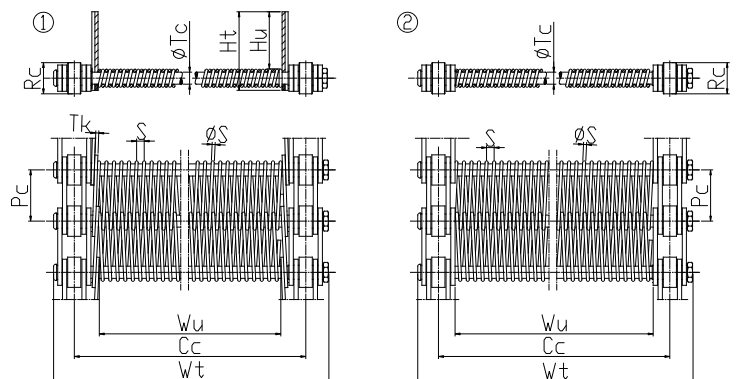

# BORDI LATERALI

## SIDE EDGES

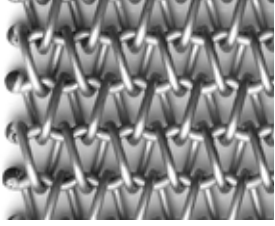

**BORDI SALDATI**  
WELDED EDGES

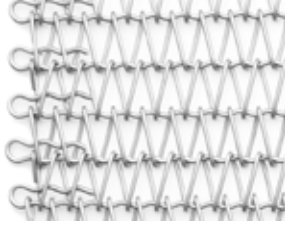

**BORDI A FORCELLA**  
BENT EDGES

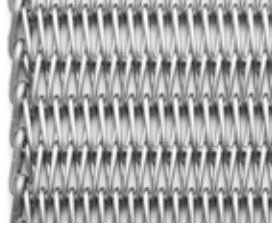

**BORDI A CATENELLA**  
LOOPED EDGES



**BORDI RIPIEGATI A SPONDINA**  
WELDED EDGES AND BENT SIDES

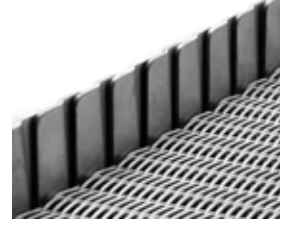

**BORDI CON SPONDINE LATERALI**  
WELDED EDGES WITH SIDES PLATES



# MATERIALI

## MATERIALS

	Werkstoff	C	Mn	P	S	Si	Ni	Cr	Mo	Mo
FE Lucido		0,016:0,06	0,32:0,39	0,006:0,011	0,016:0,1	0,016:0,1				
Fe Ramato		0,016:0,06	0,32:0,39	0,006:0,011	0,016:0,1	0,016:0,1				
C 20 Zincato		0,21	0,54	0,006	0,005	0,20				
C 38		0,38	0,64	0,001	0,001	0,21				
C 55		0,55	0,62	0,003	0,011	0,19				
18 NiCrMo5	1,6566	0,19	0,70	0,016	0,004	0,19	1,26	0,83	0,18	0Cu=0,17; Al=0,024
Ce 3%		0,045	0,048	0,013	0,011	0,29	0,07	2,9	0,54	Cu=0,09; Al=0,005; V=0,01
Cr 5%		0,05	0,53	0,012	0,013	0,36	0,05	5,74	0,55	Cu=0,06; Al=0,006
AISI 302	1,4310	0,12 max	1,5 max	0,045 max	0,15:0,35	2 max	6:9	16:18		
AISI 304	1,4301	0,07 max	2,0 max	0,045 max	0,03 max	1 max	8:10	18:20		N=0,07 max
AISI 310 S	1,4845	0,10 max	2,0 max	0,045 max	0,03 max	1,5 max	19:22	24:26		
AISI 314	1,4841	0,20 max	2,0 max	0,045 max	0,03 max	1,5:2,5	19:22	24:26		
AISI 316	1,4401	0,07 max	2,0 max	0,045 max	0,03 max	1 max	10-13	16,5:18,5	2:2,5	N=0,07 max
AISI 321	1,4541	0,08 max	2,0 max	0,045 max	0,015 max	1 max	9-12	17-19		Ti= 5xC; Ti max 0,7
AISI 330 Nb	1,4887	0,15 max	2,0 max	0,030 max	0,015 max	1:2	33:37	20:23	1:1,5	Mb 1:1,50
AISI 430	1,4016	0,08 max	2,0 max	0,04 max	0,03 max	0,6 max		16:18		
NiCr 80/20	2,4869					0,5:2	79:80	19:21		
Inconel 600	2,4816	0,15 max	1 max	0,02 max	0,015 max	0,5 max	72 min	14-17		Fe=6-10; Al=0,3 max; Cu=0,5 max Ti=0,3 max
Inconel 601	2,4851	0,1 max	1 max			0,5 max	60 min	20-22		Al= 2 max



**WBT**

**WBT SRL**

PI/VAT/TVA/CIF: 03373740137

Via XXV Aprile, 2 - 23804 Monte Marenzo (Lc) - ITALY

T. +39.0341.63.20.80

[info@wbtsrl.com](mailto:info@wbtsrl.com)

[www.wbtsrl.com](http://www.wbtsrl.com)