

siegling
belting

FOOD





CLEAN, EFFICIENT AND ALWAYS **ONE STEP AHEAD**

The food industry's a fast-paced environment. As material flow and intralogistics experts we monitor the market carefully and liaise closely with OEMs and end customers.

Today's challenges and requirements shape the direction our research and development takes. The results are practical product innovations that help our customers to gain a competitive edge.

Which is why Forbo Siegling guarantees consistent support of your HACCP concept and production processes. We also provide comprehensive services and advice the world over. And you can rest assured that our products and services will meet the demands of tomorrow's world too.

Contents

- 4 Superior reliability in all processes
- 8 Siegling Transilon conveyor and processing belts
- 21 Siegling Proposition timing belts
- 22 Siegling Prolink modular belts

HYGIENE FROM START TO FINISH

SUPERIOR RELIABILITY

IN ALL PROCESSES

With our in-depth experience of processes in all areas of the food industry, Forbo Siegling provides conveyor and processing belts, appropriate accessories and the skills to match.

We focus on flawless hygiene and top productivity – so that you can produce food reliably, safely and competitively.



Confectionery production

Forbo Siegling belts are ideal for all sorts of confectionery production – from chocolate to chewing gum. Their special characteristics support all sorts of process such as mixing, cooling, weighing, metal detecting and packaging.

Some of the products we offer include:

- belts with excellent release characteristics
- belts suitable for knife edges and ones with patterns
- belts with superior thermal conductivity and large open areas for cooling lines
- belts with exceptional resistance to oil and grease





Processing meat, poultry and seafood

From slaughtering to packaging, Forbo Siegling belts are excellent choices when it comes to productivity and food safety.

Some of the products we offer include:

- special HACCP belts with exceptional release characteristics and top resistance to hydrolysis
- incision-proof belts that are easy to clean
- blue belts for fast checking processes that don't strain eyes
- belts with fray-free edges, belt edge sealing and homogeneous belt bodies
- belts with different patterns for inclined conveying without extra profiles
- belts for deep freezing sections (cooling towers)

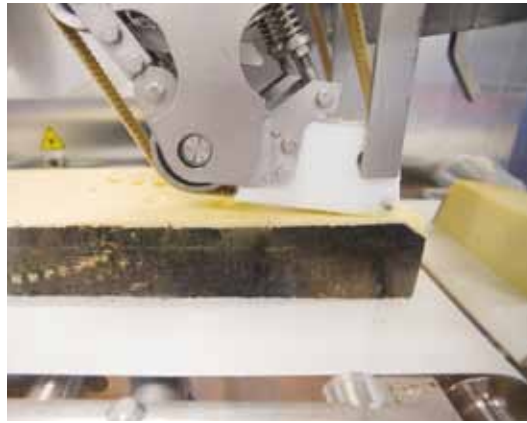

Dairy industry

In all processes in the dairy industry, from coagulating the milk to portioning, filling and packaging the finished products, Forbo Siegling's belts tick all the boxes when it's a question of hygiene and reliable production.

Some of the products we offer include:

- special HACCP belts with very good release characteristics and top resistance to hydrolysis
- incision-proof belts that are easy to clean
- special troughable belts for coagulation
- belts with fray-free edges, belt edge sealing and homogeneous belt bodies



Dough processing

Conveyor and processing belts handle virtually all processing phases in today's baked goods industry. In the production of baked goods, Forbo Siegling belts reliably ensure efficient processes and a high standard of food safety.

Some of the products we offer include:

- special HACCP belts with very good release characteristics and top resistance to hydrolysis
- blue belts for fast checking processes that don't strain eyes
- belts with fray-free edges, belt edge sealing
- elastic belts with homogeneous belt bodies (spreading belts)
- belts for deep freezing sections (cooling towers)
- belts suitable for knife edges and ones with patterns





Agricultural industry

Processing of fruit and vegetables involves a diverse range of processes. To achieve high-quality results, it's vital that produce is conveyed quickly and gently. Forbo Siegling belts treat products carefully, are fast and therefore cut production times.

Some of the products we offer include:

- belts with good resistance to fruit acids that are therefore long-lasting
- belts with profiles and side walls
- belts with large open areas for washing and drying
- very hard-wearing belts for use in abrasive environments

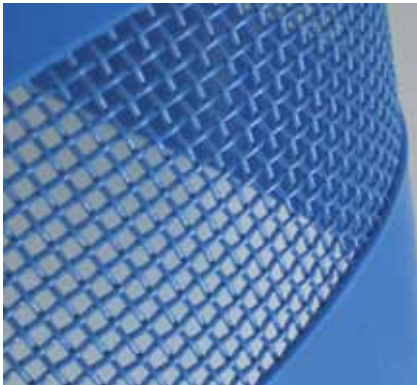

Packaging

Forbo Siegling ensures effective and dependable packaging processes thanks to a wide range of belts. Therefore, you can exploit your quality and productivity potential to the full. We can offer:

- check-weigher belts of equal thicknesses and exceptionally precise splices that make endless belts superfluous
- elastic belts for use in packaging machinery (buffer conveyors) with homogeneous structures and easy to clean surfaces
- light-permeable belts for vision-supported robot systems (pick & place)
- temperature-resistant belts for use in shrinking tunnels
- FDA- and EU-compliant folder gluers for making cardboard boxes
- round belts



For more information about round belts, folder-gluer belts and machine tapes visit www.forbo-siegling.com or take a look at these brochures:

No.	Title
227	Siegling Mesh belts – product range
229	Siegling Transilon round belts – product range
284	Siegling Extremultus folder and carrier belts
275	Siegling Extremultus machine tapes
251	Siegling Extremultus Grip Star™ – flat belts that don't let go





siegling transilon
conveyor and processing belts

SIEGLING TRANSILON

... are multi-layer, fabric-based or homogeneous belts for a wide range of conveying and processing jobs. They are true all-rounders or special belts for special applications throughout all segments of the food industry.



In terms of feedstock and migration figures, all HACCP types comply with the most important provisions and regulations (see symbols on the left). In the food segment, the majority of the Siegling Transilon PU- and PVC-types are certified as complying with Halal regulations by IFRC Asia (a member of the World Halal Council).

The properties

The advantages

compliant with EU- and/or FDA, MHLW- or Halal regulations (depending on type)	▶ types are suitable for direct contact with food
material that's easy/ flexible to process	▶ customized design (e.g. surfaces, profiles, sidewalls...)
tension members specific to application	▶ rigid or flexible depending on application
dimensionally stable	▶ can be used even when humidity and temperature fluctuate
lightweight and not very thick overall	▶ low energy consumption, very small drum diameters possible
low elongation	▶ short take-up ranges possible
closed surfaces	▶ superior cleaning and product release capabilities



HOW **SIEGLING TRANSILON** BENEFITS YOUR HACCP CONCEPT

We'll support your HACCP concept reliably in all hygiene-critical areas and in line with legal requirements. Our food range, particularly the special HACCP types, comes with a whole host of product characteristics and designs. These elements eradicate any potential safety risks in the manufacturing process.

Siegling Transilon HACCP belt

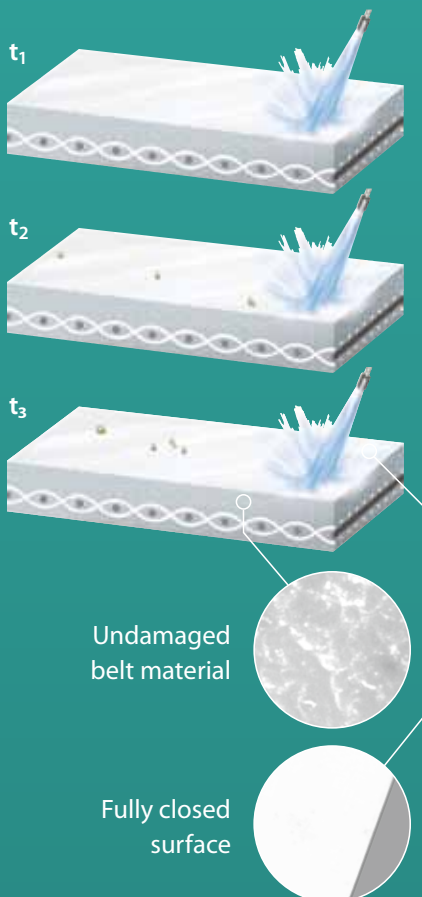

Standard conveyor belt

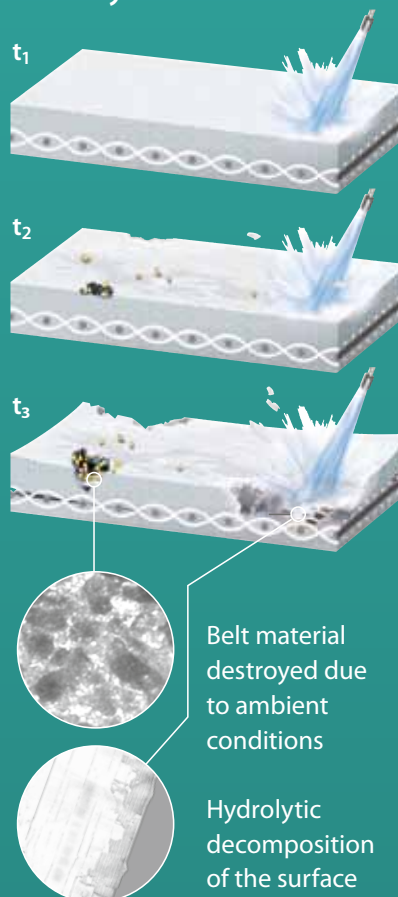

Siegling Transilon HACCP belt in comparison with a standard conveyor belt.

Influence of bacterial growth and hot water cleaning cycles on the condition of the belt or the way it functions depending on time [t].

Outstanding release properties

Due to their excellent release properties, all HACCP types are a huge advantage when processing adhesive foodstuffs. Forbo Siegling also has belts with special finishes for conveying products with a tendency to stick. They feature superb release properties, particularly in the case of sticky products like dough, caramel, or other confectionery and are easy to clean.



Belt edge sealing



When belts are made of synthetic materials and have fabric tension members, sealing closes the edges. This process prevents penetration of oil, grease and water, and therefore of bacteria in the belt edge. And the belt's service life is increased too.

Belts with Smartseal belt edge sealing are suitable for knife edges and can be made endless with all standard splice types.



Smartseal – homogeneous belt material

Fullseal



The edges of Fullseal belts can't fray. Fullseal combines the hygiene benefits of homogeneous urethane belts with the mechanical characteristics of belts with fabric tension members. Lengthways cuts between the warp fibres only separate the PU material and ensure the belt edge stays intact. Therefore fluids can't get into the belt.

Fullseal is ideal in hygiene-critical applications (such as dairy production, dough processing, meat and poultry processing).

Frayfree

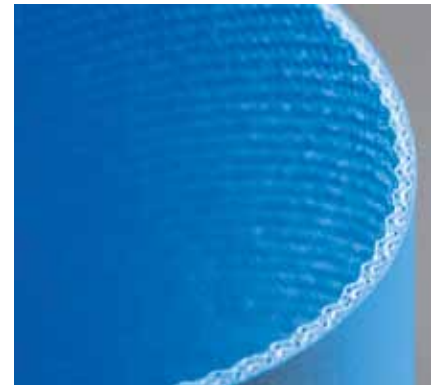

Frayfree is a belt design that keeps fraying belt edges to a minimum. A special type of fabric, a special weave and enhanced fibre length improve fibre grip in the fabric composite. Furthermore, state-of-the-art manufacturing technology ensures each of the fibres bonds with the coating material.

Frayfree belts minimize contamination with lint of the products conveyed.

SIEGLING BELTING

APPLICATION-DRIVEN DETAILS

Prosan™

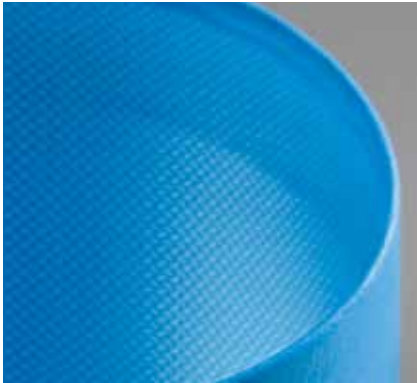

Prosan™ belts are coated on both sides and comply with hygiene requirements to the full. The pre-shrunk, very flexible tension members mean that small return radii are possible despite the coating on both sides of the belt. A patent is pending on the new underside pattern (BT = Broken Twill). It has a particularly low friction coefficient with easy-clean characteristics. Cleaning the belt is fast and straightforward.

Similarly to Frayfree belts, some unsealed Prosan™ belts have virtually fray-free edges. Optional Smartseal edge sealing also creates a belt that's fully protected.

Elastic belts

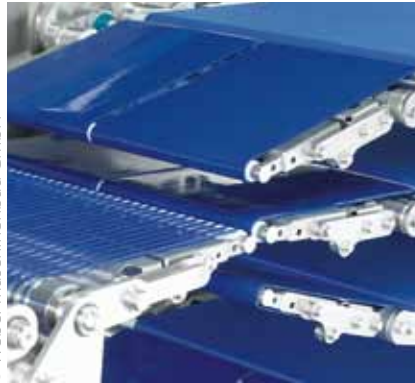

© Weber Maschinenbau GmbH

With their homogeneous structure and easy-clean surfaces, Siegling's elastic Extremultus belts score top marks on hygiene when processing unpackaged foodstuffs. They require no take-up system, track superbly and are also available as High Grip versions.

The combination of these characteristics make them top choices as dough belts, in spreader machinery, checkweighers, cutting machinery, buffer conveyors, packaging and labelling machines.

Profiles and sidewalls



Conveyor belts with profiles are used for inclined and steep conveying of bulk goods and small products. Profiles are available in various shapes and dimensions.

Sidewalls (often combined with lateral profiles) are used to contain bulk goods at the sides. Forbo Siegling's sidewall range is exceptionally food-safe and offers diverse options for unusual conveyor designs.

More information on Siegling products relevant to the food industry can be found in the following brochures:

No.	Title
120	The new sidewall range
205	Belts for the food and packaging industries – blue, safe and elastic
228	Tobacco
253	Prosan™ – Hygienic and safe all the way
317	Siegling Transilon Technical information 1, storage, finishing, fitting
318	Siegling Transilon Technical information 2, special features and properties



Belt scrapers

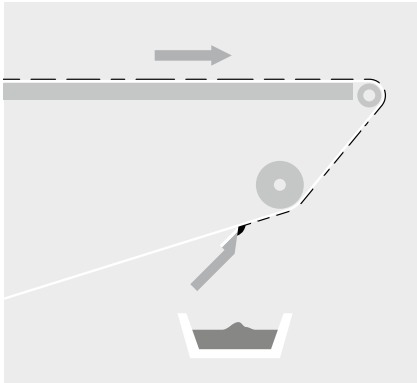

To produce hard-wearing, rigid scrapers, materials with different levels of hardness are processed to make one single part. Therefore, the scraper is very inherently stiff and can often be used without any additional support.

The highly elastic scraper lip lies very evenly over the entire width of the belt.

Consequently, they have significant advantages compared with conventional metal scrapers:

- the belt and the scraper last much longer
- scraping is more thorough
- they are up to four times more robust than UHMW scrapers
- they are easier to clean

Surface patterns

Special surface patterns can enhance the grip and release characteristics of many products and emboss the bottom (e.g. in the case of chocolate). We can custom-produce any type of embossing. Just come and talk to us.

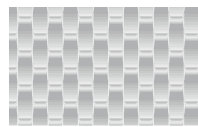

DIA Diagonal



FG Herringbone

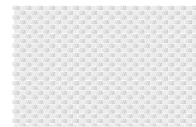

Fine Fabric, fine

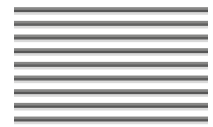

LG Longitudinal groove



MT Matte

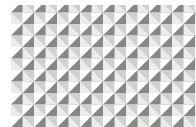

NP Inverted pyramid



QS Quartz sand

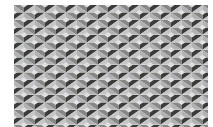

RF Fine rhomboid

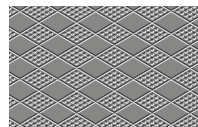

RFF
Flat fine rhomboid

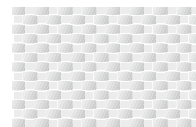

Rough Fabric, rough

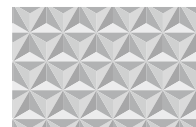

SP Star pyramid



TRI Triangle, crosswise

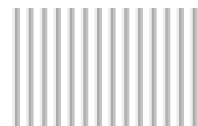

WG Wide groove

Suitable for knife edges

Belts that can handle knife edges are required for some applications, i.e. cooling lines, so that even the very smallest of products is transferred properly to the next belt.

Siegling Transilon belts are ideal for very small knife edge radii – special types can also be used in curves and merges. The belts lie very flat, so that even lightweight products are positioned correctly on long conveyors.

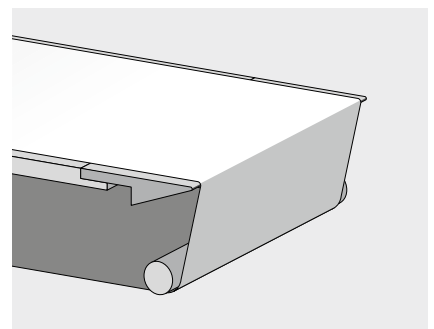

SIEGLING TRANSILON FOOD PRODUCT RANGE

Technical data, properties and recommendations, possible applications	Article number	Total thickness approx. [mm]	Weight approx. [kg/m ²]	Effective pull at 1% elongation (k _{1%} relaxed) [N/mm width]*	d _{min} counter-bend / d _{min} bend / r _{min} knife approx. [mm]**	Permissible operating temperature [°C]	Hardness of the top face coating [Shore A]	Standard width supplied / max. width supplied [mm]	Food compliance with EC / FDA / Halal / MHLW***
A – Polyolefin									
E 4/2 X0/A2 MT-HACCP blue FDA	906713	1.3	1.15	5	40/14/r5	-10/+60	92	3100 ³⁾	E/F/-/-
E 4/2 A0/A2 MT-HACCP white FDA	906660	1.3	1.15	5	40/14/r5	-10/+60	92	3400 ³⁾	E/F/-/-
E 8/2 0/A2 MT-TT white FDA	906775	1.6	1.35	4.5	60/24/-	-10/+120		3000	E/F/-/M
E 8/2 X0/A2 MT-NA-HACCP white FDA	906776	1.7	1.5	9.5	50/14/r5	-10/+60	90	3350	E/F/-/-
E 10/2 E0/A4 TT transparent	906652	2.25	2	7.5	60/-/-	-10/+60	90	4350 ³⁾	E/F/-/-
C/O – Cotton/fabric, uncoated									
E 2/2 U0/U0 transparent FDA	906735	1.1	1.2	3.5	14/-/r3	-30/+100		3000	E/F/H/-
EP 3/2 U0/0 NA transparent FDA	906599	0.9	0.8	2.5	40/8/r1.5	-30/+100		1400	E/F/H/-
E 3/2 0/U/C FINE white	999638	1.4	1.4	2.5	24/14/r3	-10/+100		1350	E/-/-/M
E 3/2 0/U/C ROUGH white	999637	2.1	1.8	2	30/-/r3	-30/+100		1400 ³⁾	E/-/-/M
E 3/2 U0/U/C ROUGH blue	906729	2	1.7	3	30/14/r5	-30/+100		2900	E/-/-/-
E 3/2 U0/U/C ROUGH transparent	906667	2	1.7	3	30/14/r5	-30/+100		2900	E/-/-/-
E 4/2 0/U/0 NA-PS white FDA	907014	1.65	1.6	4	14/-/r3	-30/+100		2100	-/F/H/-
E 5/2 0/0 transparent	900104	1.45	1.5	1	24/-/-	-10/+70		3100 ³⁾	E/-/H/-
E 6/2 0/U/0 CR-NA white FDA	907083	1.75	1.5	3.5	14/-/-	-30/+100		2100 ³⁾	-/F/H/-
E – Polyester									
E 12/2 E0/E3 MT-TT transparent	900348	1.7	1.8	10.5	40/16/-	-30/+100	92	4500 ³⁾	E/F/-/-
N/F – NOVO/Polyester felt									
E 6/1 U0/F20 white FDA	900130	2.5	1.4	4.5	40/30/r4	-30/+100		1450 ³⁾	E/F/-/-
NOVO 25 NA white	996160	2.6	1.35	7	40/-/-	-10/+120		2000 ³⁾	E/-/-/-
P – Polyamide									
P 3/3 P0/P0 transparent FDA	906786	1	1	1.5	60/25/-	-30/+100	75	1900 ³⁾	-/F/-/-
R – HighGrip									
E 4/1 U0/R2 HACCP-FF white FDA	906665	1.15	1.15	3	30/-/r3	-30/+100	55	3100	E/F/H/-
E 4/2 U0/R2 HACCP-FF white FDA	906705	1.35	1.55	5.5	30/14/r5	-30/+100	76	3100 ³⁾	E/F/H/-
E 4/2 U0/R2 HACCP-FF blue FDA	906869	1.35	1.55	5.5	30/14/r3	-30/+100	76	3100	E/F/H/-
E 8/2 U0/R10 LG blue FDA	906805	2.4	2.5	6.5	24/14/-	-30/+100	65	1400 ³⁾	E/F/-/M
S – Silicone									
E 3/1 U0/S3 white FDA	900184	1.1	1.05	2.5	24/8/r3	-30/+100	30	3100	E/F/-/-
E 3/1 U0/S3 HACCP-FF blue FDA	906760	1	1	2	14/8/r3	-30/+100	30	3100	E/F/-/-
E 3/1 U0/S3 HACCP-FF-PS white FDA	906828	1.1	1.1	2	14/8/r3	-30/+100	30	3050	E/F/-/-
E 4/2 S0/S0 transparent FDA	900135	1.3	1.1	5	40/-/-	-40/+180		3100	E/F/-/-
E 4/2 S0/S3 FSTR white FDA	900136	1.5	1.6	4.5	40/-/-	-40/+180	30	3100	E/F/-/-
E 6/2 U0/U/S3 white FDA	906477	1.6	1.8	5	40/10/r3	-30/+100	30	3100	E/F/-/-
E 8/H S0/S5 MT-HACCP white FDA	906478	1.4	1.5	6	30/10/-	-40/+180	60	2900	E/F/-/-
U – Polyurethane									
E 2/1 U0/U2 HACCP white FDA	900176	0.65	0.65	2.5	14/8/r3	-30/+100	85	3000/4500 ⁴⁾	E/F/H/-
E 2/1 U0/U2 MT blue FDA	906546	0.6	0.6	2	14/8/r3	-30/+100	92	3000/4600 ⁴⁾	E/F/H/-
E 3/1 0/U2 white FDA	994327	0.9	0.9	1	14/-/r3	-30/+100	85	1400	E/F/-/M
E 3/1 U0/U2 GL-NA amber FDA	900397	0.75	0.8	2.5	14/8/r3	-30/+100	85	3200	E/F/H/-
E 3/1 U0/U2 white FDA	907006	1.05	1.1	3.5	40/-/r3	-30/+100	85	2100	-/F/-/-
E 3/1 U0/U2 HACCP white FDA	900006	1.15	1.2	3	14/8/r3	-30/+100	85	3000/4600 ⁴⁾	E/F/H/M
E 3/1 X0/U2D GL-HACCP-FF white FDA	906823	1	1	2.5	14/8/r3	-20/+100	85	3200	E/F/-/-
E 3/1 U0/U2 MT-NA-HACCP white FDA	900201	0.8	0.9	3	14/8/r3	-30/+100	85	3100	E/F/H/-
E 3/1 U0/U2 MT-NA-HACCP-FF blue FDA	906662	0.85	0.9	3	14/8/r3	-30/+100		3200	E/F/H/-
E 3/1 U0/U2 HACCP-FF-PS blue FDA	906854	1.1	1.1	3	14/8/r3	-30/+100	85	3100	E/F/H/M
E 3/1 X0/U2D MT-HACCP-FF white FDA	906730	1	1	2.5	14/8/r3	-20/+100	85	3200	E/F/-/-
E 3/1 U0/U2 MT-G-HACCP blue FDA	906602	0.7	0.7	2.5	14/8/r3	-30/+100	85	3200	E/F/H/-
E 3/1 U0/U2 MT-G-HACCP white FDA	900008	0.7	0.7	2.5	14/8/r3	-30/+100	85	3200	E/F/H/-

SIEGLING TRANSILON

FOOD PRODUCT RANGE

Technical data, properties and recommendations, possible applications	Article number	Total thickness approx. [mm]	Weight approx. [kg/m ²]	Effective pull at 1% elongation (k _{10%} relaxed) [N/mm width]*	d _{min} counter-bend / d _{min} bend / r _{min} knife approx. [mm]**	Permissible operating temperature [°C]	Hardness of the top face coating [Shore A]	Standard width supplied / max. width supplied [mm]	Food compliance with EC / FDA / Halal / MHLW***
E 3/1 U0/U2 RF brown FDA	900007	1.2	1.1	3.75	14/8/r3	-30/+100	85	1500	E/F/H/-
E 3/1 U0/U2 RFF-NA amber FDA	900398	0.8	0.8	2.5	14/8/r3	-30/+100	85	1630	E/F/H/-
E 3/1 U0/U2 RFF-HACCP white FDA	906726	1.15	1.1	3	14/8/r3	-30/+100	85	1630	E/F/H/M
E 3/1 U0/U2 RFF-NA-HACCP-FF blue FDA	906770	0.9	0.9	3.25	14/8/r3	-30/+100	85	1630	E/F/H/-
E 3/1 U2/U2 BT/MT-HACCP-FF blue FDA	904697	1.4	1.6	3	30/14/r5	-30/+100	95	1400	E/F/-/M
E 3/1 U2/U2 BT/MT-HACCP-FF white FDA	904698	1.4	1.6	3	24/14/r5	-30/+100	95	1400	E/F/-/M
E 3/1 U0/U3 HACCP white FDA	904595	1.35	1.25	3.5	30/-/r3	-30/+100	86	1400	E/F/-/M
E 3/1 U0/U3 SP-NA amber FDA	906733	1	0.9	2.5	24/-/r3	-30/+100	85	1500	E/F/H/-
E 3/1 U0/U5 SP-PS white FDA	906177	1.55	1.5	2	24/14/r3	-30/+100	85	1450	E/F/H/-
E 3/2 U0/U2 NA white FDA	900085	1.45	1.6	5.75	24/14/r3	-30/+100	85	3100 ³⁾ /4600 ⁴⁾	E/F/H/M
E 3/2 U0/U2 HACCP white FDA	900103	1.4	1.6	5.5	24/8/r3	-30/+100	85	3100 ³⁾ /4600 ⁴⁾	E/F/H/M
E 3/2 U0/U2 HACCP-FF blue FDA	906664	1.5	1.6	5	24/8/r3	-30/+100	85	3200 ³⁾	E/F/H/-
E 3/2 U0/U2 MT blue FDA	906211	1.4	1.55	6	25/-/r3	-30/+100	85	2200	-/F/-/-
E 3/2 U0/U2 MT white FDA	900447	1.45	1.6	5.5	24/8/r3	-30/+100	85	3000 ³⁾ /4600 ⁴⁾	E/F/H/-
E 3/2 U0/U4 DIA-HACCP-FF blue FDA	906852	2	1.75	5.5	24/14/-	-30/+100		1450	E/F/H/-
E 3/2 U0/U4 GSTR white FDA	999947	2.2	1.9	3	60/-/-	-30/+100	86	1400 ³⁾	E/F/-/M
E 3/2 U0/U10 WG-HACCP blue FDA	906768	2	1.8	4	24/14/-	-30/+100	85	1400	E/F/-/M
E 4/1 U0/U2 NA white FDA	907058	0.8	0.95	3	40/-/r3	-30/+100	85	2100 ³⁾	-/F/-/-
E 4/2 U0/U2 white FDA	996009	1.3	1.4	4	40/-/r3	-30/+100	85	2100	-/F/-/-
E 4/2 U0/U2 HACCP-FF white FDA	906645	1.35	1.55	5	14/-/r3	-30/+100	92	3200 ³⁾	E/F/H/-
E 4/2 U0/U2 LF white	906373	1.35	1.5	4	24/14/r3	-30/+100	85	3100 ³⁾	E/-/-/
E 4/2 U0/U2 SMT-HW-HACCP-PS blue	904454	1.4	1.6	3	14/-/r3	-30/+100	95	1400 ³⁾	E/-/-/M
E 4/2 U0/U2 SMT-HW-HACCP-PS white	904441	1.4	1.7	3	14/-/r3	-30/+100	95	1400 ³⁾	E/-/-/M
E 4/2 U0/U2 MT blue FDA	906540	1.35	1.55	4	24/14/r3	-30/+100	92	3000 ³⁾ /4600 ⁴⁾	E/F/H/-
E 4/2 U0/U2 MT-PS white FDA	907192	1.3	1.4	3	40/-/r3	-30/+100	92	2100 ³⁾	-/F/H/-
E 4/2 U0/U2 MT-HACCP white FDA	900207	1.35	1.55	4	24/14/r3	-30/+100	92	3100 ³⁾ /4600 ⁴⁾	E/F/H/M
E 4/2 U0/U2 MT-HACCP-FF blue FDA	906663	1.4	1.55	5.75	24/14/r3	-30/+100	92	3200 ³⁾	E/F/H/-
E 4/2 U0/U2 QS-HACCP-FF blue FDA	906765	1.35	1.5	4.75	24/14/r3	-30/+100	92	2000	E/F/H/-
E 4/2 U2/U2 BT/MT-HACCP-FF blue FDA	904699	1.4	1.6	4	30/14/r5	-30/+100	95	1400	E/F/-/M
E 4/2 U2/U2 BT/MT-HACCP-FF white FDA	904696	1.4	1.6	4	30/14/r3	-30/+100	95	1400	E/F/-/M
E 4/2 U0/U3 NP-HACCP-FF blue FDA	906835	1.65	1.7	5.5	30/14/r5	-30/+100	92	3100 ³⁾	E/F/H/-
E 4/H U8/U8 NP/MT-NA blue FDA	907139	2.5	2.8	2	30/24/-	-30/+100	92	1600	E/F/-/-
E 8/2 U0/U2 C white FDA	999619	1.25	1.3	5.5	14/-/-	-30/+100	86	2100 ³⁾	-/F/H/M
E 8/2 U0/U2 MT-NA white FDA	900277	1.4	1.45	6.5	24 ²⁾ /8/r5	-30/+100	85	3100 ³⁾	E/F/H/-
TE 80/2 0/2U MT-Q-NA white FDA	907157	1.5	1.7	5.5	14/-/-	-30/+100	85	2100 ³⁾	-/F/-/-
E 8/2 U0/U5 white FDA	907048	1.7	1.85	5	25/-/-	-30/+100	85	2100 ³⁾	-/F/-/-
E 8/2 U0/U5 MT CL transparent FDA	997001	1.85	2	5.5	40/20/-	-30/+100	92	2100	-/F/-/-
E 8/2 U0/U5 MT white FDA	907049	1.7	1.85	5	25/-/-	-30/+100	92	2100 ³⁾	-/F/-/-
E 8/2 U0/U5 MT-HACCP blue FDA	906804	1.6	1.7	6.5	24/14/r5	-30/+100	92	3200 ³⁾	E/F/H/-
E 8/2 U0/U5 MT-HACCP white FDA	906692	1.6	1.7	7	24/14/r5	-30/+100	92	3200 ³⁾	E/F/H/-
E 8/2 U0/U5 QS-HACCP white FDA	906777	1.6	1.7	5.5	24/14/r5	-30/+100	92	2000	E/F/H/-
E 8/2 U0/U8 transparent FDA	900024	2	2.2	7.5	30/24/-	-30/+100	85	3050 ³⁾	E/F/H/-
E 8/2 U0/U8 blue FDA	906842	2	2.2	7.5	30/24/-	-30/+100	85	3050 ³⁾	E/F/H/-
E 8/2 U0/U8 CTP transparent FDA	906830	3.6	2.3	7	30/-/-	-30/+100	85	1300	E/F/H/-
E 8/2 V1/V/U10 MT transparent FDA	907128	2.3	2.8	7	60/-/-	-10/+70	92	2100	-/F/-/-
E 8/H U0/U2 MT-HACCP blue FDA	906473	1.35	1.25	8	30/-/r3	-30/+100	85	3100	E/F/H/-
E 8/H U0/U2 MT-HACCP white FDA	906451	1.35	1.25	8	30/8/r3	-30/+100	85	3100	E/F/H/-
E 8/H U2/U2 MT/MT-HACCP blue FDA	906604	1.6	1.7	8.5	60/10/r5	-30/+100	85	3000	E/F/H/-
E 8/H U0/U5 NP-HACCP blue FDA	906605	1.6	1.65	8	60/-/r3	-30/+100	85	3100	E/F/H/-
E 8/H U0/U5 NP-HACCP white FDA	906489	1.6	1.65	7.5	40/24/r3	-30/+100	85	3100	E/F/H/-
E 10/H X0/U2 MT-HACCP transparent FDA	906557	1.25	1.15	8	14/10/r3	-30/+100	85	3200	E/F/H/-
E 14/2 U0/U4 MT-M white FDA	906698	2.9	3	15.5	40/24/-	-30/+100	85	1300 ³⁾ /3000 ⁴⁾	E/F/H/-
E 18/H U0/U2 MT white FDA	906420	1.75	1.75	17.5	24 ²⁾ /-/	-30/+100	85	4750 ⁴⁾	E/F/H/-



	Laterally stiff	Troughable	Suitable for knife edges	Low noise	Good heat conductivity	Good resistance to oil and grease	Incision resistant	Good release properties	Profiles on the top face/underside/side wall	Belt edge sealing****	Available in AP = Asia Pacific, AA = America, EU = Europe, GL = globally*****
	●		●		●	●	●	●	5) / ● / -	P/S	GL
	●		●		●	●	●	●	- / - / -	S	EU
	●		●		●	●	●	●	5) / ● / -	5)	EU
	●		●		●	●	●	●	● / ● / -	S	AA
	●		●		●	●	●	●	● / ● / -	S	GL
	●		●		5)	●	●	●	● / ● / -	S	GL
	●		●		●	●	●	●	● / ● / -	S	AP
	●		●		●	●	●	●	- / β) / -	5)	EU, AP
	●		●		●	●	●	●	- / ● / -	P/S	EU
	●		●		●	●	●	●	● / ● / ● ⁹⁾	S	GL
	●		●		●	●	●	●	● / ● / ● ⁹⁾	P/S	GL
	●		●		5)	●	●	●	● / ● / ● ⁹⁾	S	GL
	●		●		●	●	●	●	● / ● / -	S	AA, AP
	●		●		●	●	●	●	● / ● / -	5)	EU
	●		●		●	●	●	●	● / ● / -	S	EU
	●		●		●	●	●	●	● / ● / ⁵⁾	S	AA, AP
	●		●		●	●	●	●	● / ● / ●	P/S	GL
	●		●		5)	●	●	●	● / ● / -	S	AA, AP
	●		●		●	●	●	●	● / ● / ● ⁹⁾	S	AA
	●		●		●	●	●	●	● / ● / ● ⁹⁾	5)	GL
	●		●		5)	●	●	●	- / ● / -	P/S	GL
	●		●		5)	●	●	●	● / ● / -	S	AP
	●		●		●	●	●	●	● / ● / -	S	AP
	●		●		●	●	●	●	● / ● / -	P/S	GL
	●		●		5)	●	●	●	5) / β) / -	S	AA
	●		●		●	●	●	●	● / ● / ● ⁹⁾	P/S	GL
	●		●		●	●	●	●	● / ● / ● ⁹⁾	S	GL
	●		●		●	●	●	●	● / ● / ●	S	EU
	●		●		●	●	●	●	● / ● / -	S	GL
	●		●		●	●	●	●	● / ● / ⁵⁾	S	GL
	●		●		●	●	●	●	● / ● / ●	5)	GL
	●		●		5)	●	●	●	● / ● / -	5)	AA, AP
	●		●		5)	●	●	●	● / ● / -	S	AA
	●		●		●	●	●	●	● / ● / ●	S	AA, AP
	●		●		●	●	●	●	● / ● / ●	S	AA
	●		●		●	●	●	●	● / ● / ●	S	AA
	●		●		●	●	●	●	● / ● / ●	S	EU
	●		●		●	●	●	●	● / ● / ●	5)	EU, AA
	●		●		●	●	●	●	● / β) / ●	5)	EU
	●		●		●	●	●	●	● / ● / ●	P/S	GL
	●		●		●	●	●	●	● / ● / ⁵⁾	S	EU
	●		●		●	●	●	●	- / ● / -	S	EU
	●		●		●	●	●	●	● / ● / ⁵⁾	S	AA
	●		●		●	●	●	●	● / ● / -	P/S	GL
	●		●		●	●	●	●	● / ● / ● ⁹⁾	P/S	GL
	●		●		●	●	●	●	● / ● / -	P/S	EU, AA
	●		●		●	●	●	●	● / ● / -	P/S	GL
	●		●		●	●	●	●	● / ● / ●	P/S	GL
	●		●		●	●	●	●	● / ● / ●	P/S	GL
	●		●		●	●	●	●	● / - / -	S	EU, AA
	●		●		●	●	●	●	● / ● / ●	S	EU
	●		●		●	●	●	●	● / ● / ●	S	GL

- * Established in line with ISO 21181:2005
- **
 - Minimum drum diameter d_{min} with counter-bending (top face touches drum)
 - Minimum drum diameter d_{min} with bending (driving face touches drum)
 - Minimum radius r_{min} of a fixed knife edge (rX) or minimum diameter d_{min} of a rolling knife edge (dX) (driving face touches knife edge)
- Missing values on request. The smallest permissible drum diameters were established at room temperature with z-splices and counter bending and do not apply to conveyor belts with mechanical fasteners. Lower temperatures, profiles and side walls can require larger drum diameters. On this point, see our brochure "Technical information 2" (ref. no. 318)
- *** E = (EU) 10/2011 and (EC) 1935/2004, F = Food and Drug Administration, H = Halal certified, M = MHLW Notification no. 370
- **** P = Proseal, S = Smartseal
- ***** Please inquire if not available in your region
- 2) Lower values for special applications possible. Please inquire
- 3) Larger widths with longitudinal seam possible
- 4) Maximal widths without longitudinal seam on request
- 5) Please inquire
- 6) No Z-splice – see data sheet
- 7) Rolling knife edge
- 8) Smaller minimum drum diameter with counter-bending on request
- 9) Welding on of sidewalls by HF recommended
- Yes
- Yes, particularly suitable
- Partly suited, on request

Legend continued on the next double page.

SIEGLING TRANSILON

FOOD PRODUCT RANGE

Technical data, properties and recommendations, possible applications	Article number	Total thickness approx. [mm]	Weight approx. [kg/m ²]	Effective pull at 1% elongation (k _{1%} relaxed) [N/mm width]*	d _{min} counter-bend / d _{min} bend / r _{min} knife approx. [mm]**	Permissible operating temperature [°C]	Hardness of the top face coating [Shore A]	Standard width supplied / max. width supplied [mm]	Food compliance with EC / FDA / Halal / MHLW***
U0/U0 – Fabric, polyurethane impregnated									
E 2/1 U0/U0 NA transparent	900001	0.55	0.4	2.5	30/-/r3	-30/+100		1400	E/-/-/M
E 2/1 U0/U0 NA transparent FDA	907222	0.55	0.4	2.5	30/-/r3	-30/+100		2000	E/F/-/-
E 3/1 U0/U0 transparent FDA	906430	0.85	0.6	3	14/8/r3	-30/+100		3000/4500 ⁴⁾	E/F/H/-
E 3/1 U0/U0 white FDA	900177	0.9	0.7	2.5	40/-/r3	-30/+100		2100	-/F/-/-
E 3/1 U0/U0 PS blue FDA	906681	0.85	0.7	3	14/8/r3	-30/+100		3100	E/F/H/-
E 3/2 U0/U0 transparent FDA	900009	1.2	1.1	4.5	14/8/r3	-30/+100		4600 ³⁾	E/F/H/-
E 4/1 U0/U0 NA green FDA	907075	0.6	0.4	3	40/-/r3	-30/+100		2100 ³⁾	-/F/-/-
E 4/2 U0/U0 transparent FDA	900206	1.1	1.1	3.75	24/14/r3	-30/+100		3200/4650 ⁴⁾	E/F/H/M
E 4/2 U0/U0 HACCP-FF blue FDA	906723	1.05	0.9	3	24/14/r3	-30/+100		3100	E/F/H/-
E 6/2 U0/U0 blue FDA	906558	1	0.9	4	30/24/r3	-30/+100		3100 ³⁾	E/F/H/-
E 12/2 U0/U0 transparent FDA	900040	1.4	1.4	10.5	40/-/-	-30/+100		4650 ³⁾	E/F/H/M
V – Polyvinyl chloride									
E 5/2 0/V3 MT-NA white FDA	900015	1.85	2.15	3	30/24/-	-10/+70	65	2800 ³⁾	E/F/H/-
E 8/2 U0/V4 MT blue FDA	906595	2.1	2.3	6	30/24/-	-10/+70	72	3100 ³⁾	E/F/H/-
E 8/2 U0/V5 MT white FDA	900028	2.2	2.5	6	30/24/-	-10/+70	65	4500 ³⁾	E/F/H/-
E 8/2 U0/V5 NP white FDA	900029	2.1	2.15	6	40/30/-	-10/+70	65	3100 ³⁾	E/F/H/-
TE 80/2 5V/8V NP/GL-NA blue FDA	903984	2.7	3.15	6	60/-/-	-10/+70	65	2000 ³⁾	-/F/-/-
E 8/2 V5/V8 NP/MT blue FDA	906567	2.85	3.2	6	40/-/-	-10/+70	72	3100 ³⁾	E/F/H/-
E 8/2 U0/V18 TRI blue FDA	906612	3.5	3.5	5	40/-/-	-10/+70	72	1250	E/F/H/-
E 10/M V1/V10 MT blue FDA	906533	2.85	3.3	6	60/40/-	-10/+70	56	3100 ³⁾	E/F/H/-
E 10/M V1/V10 MT white FDA	900092	2.85	3.3	5.75	60/40/-	-10/+70	55	3050 ³⁾	E/F/H/-
E 12/2 U0/V7 MT white FDA	909145	2.8	3.45	10	60/-/-	-10/+70	65	2000 ³⁾	-/F/-/-
E 12/2 U0/V20 FG-NA white FDA	900051	5.2	3.9	10	60/-/-	-10/+70	65	1500 ³⁾	E/F/H/-
E 12/2 U0/V20 MT-NA white FDA	900050	3.7	4.4	11	60/40/-	-10/+70	65	3100 ³⁾	E/F/H/-
E 15/M V1/V10 MT white FDA	900093	5	5.3	8.5	90/-/-	-10/+70	65	3000 ³⁾	E/F/H/-
Elastic belts									
UU 20U-NA FSTR/FSTR white FDA	995385	1.0	1.15	0.08	10/-/-	-20/+60		600/1200	E/F/-/M
UU 20U-NA FSTR/FSTR blue FDA	855576	1.0	1.15	0.11	10/-/-	-20/+60		600/1200	E/F/-/M
UU 20U-10 NA FSTR blue HACCP FDA	855645	1.0	1.15	0.11	15/-/-	-20/+60		600/1200	E/F/-/M
UU 20U-9 GSTR/FSTR black/blue HACCP FDA	855646	0.9	0.85	0.07	14/-/-	-20/+60		600/1200	E/F/-/M
UU 20U-NA FSTR/NP blue FDA	855590	1.4	1.5	0.1	10/-/-	-20/+60		600/1200	E/F/-/M
UR 20U GSTR/FSTR black/blue	855624	1.5	1.6	0.2	10/-/-	-20/+60		600/1200	-/-/-/-
UU 40U-NA FSTR/FSTR blue FDA	855584	1.1	1.1	0.2	20/-/-	-20/+60		600/1200	E/F/-/-
UU 40U-12 NA NP/STR blue HACCP FDA	855629	1.15	1	0.2	14/-/-	-20/+60		600/1200	E/F/-/M
UR 40U-12 FSTR blue FDA	855647	1.2	1.3	0.13	10/-/-	-20/+60		600/1200	E/F/-/-
UU 60U-NA FSTR/FSTR blue FDA	855595	1.6	1.65	0.3	20/-/-	-20/+60		600/1200	E/F/-/-



Laterally stiff	Troughable	Suitable for knife edges	Low noise	Good heat conductivity	Good resistance to oil and grease	Incision resistant	Good release properties	Profiles on the top face/underside/side wall	Belt edge sealing****	Available in
●		●		5)				5)●/—	5)	AP
●		●		5)				5)●/—	5)	AA
●		●			●		●	●/●/—	P	GL
●		●		5)				5)●/—	S	AA
●		●			●		●	5)●/—	P	EU
●		●			●		●	●/●/—	P/S	GL
●		●		5)				5)●/—	S	AA
●		●			●		●	●/●/—	S	GL
●	●	●		●	●		●	●/●/—	S	GL
●		●			●		●	●/●/—	P/S	GL
●●		●	●		●		●	●/●/—	S	EU, AA
●	●				●			●/●/—	P/S	EU
●					●			●/●/—	P/S	EU
●					●			●/●/●	GL	GL
●					●			●/●/●	P/S	GL
●					●	●		●/●/●	S	AP
●					●	●		●/●/5)	P, S	EU, AP
●					●	●		●/●/—	S	EU, AP
●	●				●	●		●/●/●	S	EU
●	●				●	●		●/●/●	P/S	GL
●			●					●/β/●	S	AP
●								—/●/—	5)	GL
●					●	●		●/●/●	P/S	EU, AP
○	○							●/●/●	5)	EU, AP
	●	7)	●		●		●	5)		GL
	●	7)	●		●		●	5)		GL
	●	7)	●		●		●	5)		GL
	●	7)	●		●		●	5)		GL
	●	7)	●		●		●	5)		GL
	●	7)	●		●		●	5)		AA, EU
	●	7)	●		●		●	5)		EU
	●	7)	●		●		●	5)		GL
	●	7)	●		●		●	5)		GL
	●	7)	●		●		●	5)		AA, EU

Legend continued from the previous double page.

Tension member fabrics

- E = Polyester
- EP = Polyester/polyamide blended fabric
- NOVO = Polyester felt
- P = Polyamide

Design

- 1, 2, 3 = Number of fabric plies
- H = HighTech-fabric
- M = Solid-woven material

Coatings

- 0 = Fabric uncoated
- A = Polyolefin
- C = Cotton
- E = Polyester
- F = Polyester felt
- P = Polyamide
- S = Silicone
- R = High Grip
- U = Polyurethane
- U0 = Polyurethane impregnation
- V = Polyvinyl chloride

Surface patterns

- BT = Broken twill
- DIA = Diagonal
- FG = Herringbone
- Fine = Fabric, fine
- FSTR = Fine texture
- GL = Smooth
- GSTR = Coarse texture
- LF = Smooth, low friction
- LG = Longitudinal groove
- MT = Matte
- NP = Inverted pyramid
- QS = Quartz sand
- RF = Fine rhomboid
- RFF = Flat fine rhomboid
- Rough = Fabric, rough
- SMT = Semi-matte
- SP = Star pyramid
- TRI = Triangle, crosswise
- WG = Wide groove

Belt properties

- C, Q = Laterally flexible, suitable for curved belts
- FDA = In compliance with FDA – see data sheet & table regarding EC & MHLW
- FF = Non-fraying (Frayfree)
- HACCP = Supports the HACCP concept
- HW = Hot-water resistant
- LF = Low friction
- NA = Non-antistatic
- PS = Pre-shrunk
- TT = Pyrolysis compliant (tobacco type)

SIEGLING BELTING FABRICATION

Splice types

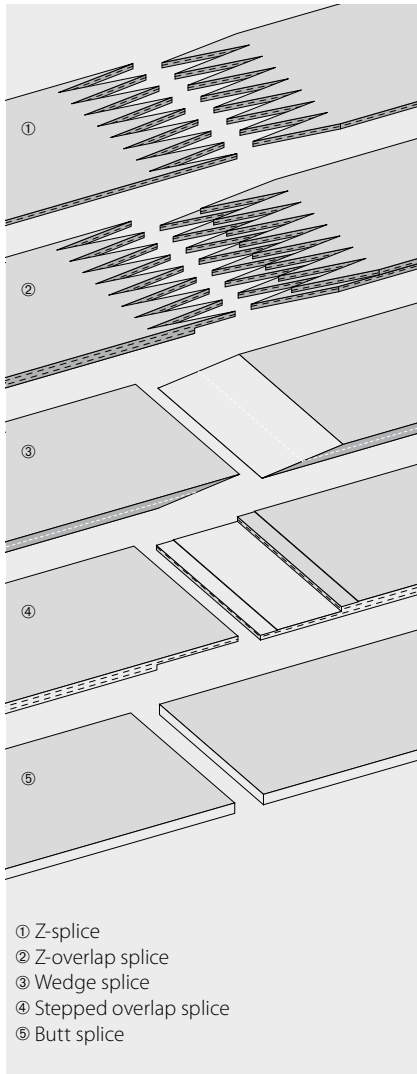

Different types of splice are used depending on the belt and application. (All types are also suitable for belts with edge sealing).

Mechanical fasteners

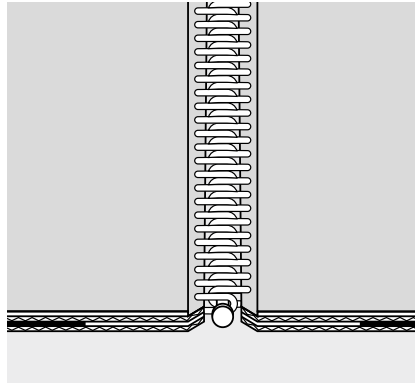

Mechanical fasteners allow belts to be made endless quickly and easily. Belts can also be fitted and removed without the need to dismantle parts of the machinery.

Plastic fasteners are normally chosen for the food industry. They are:

- EU- and FDA-compliant
- ideal for use in metal detectors
- also available as versions that can be embedded or heated into the belt coating

Metal fasteners are only used in exceptional cases (e.g. in the agricultural industry).

Using lasers on belts



Applying lettering or images by laser is an impressive alternative to screen-printed and foil methods: the printed image is created by recoloring the surface by laser. Because of its extreme durability, precise positioning and crisp printing results, this process opens up new ways of using belts, for example:

- precisely applied positioning grids and control markings for optical sensors help in automated processes (e.g. in pizza manufacturing and bakery machines)
- technical data, belt characteristics and ordering codes can be permanently stored on the top face
- almost any visuals can be added as lasting advertising (i.e. on check-out counter belts)



siegling proposition timing belts

Perforations

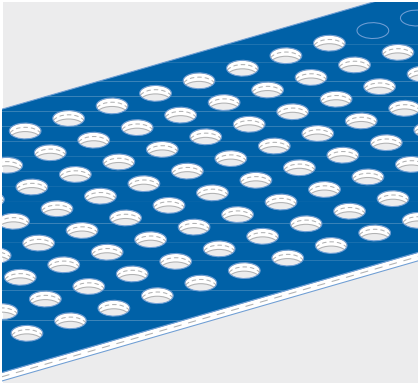

Siegling Transilon material can have virtually any number of perforations with high precision tolerances.

Siegling Transilon products are supplied as:

- endless belts
- prepared belts for on-site splicing
- roll material
- belts with mechanical fasteners
- belts with sealed edges (Smartseal, Proseal)
- belts with profiles welded on (longitudinal, lateral, diagonal, semi-circle)
- belts with sidewalls
- belts with perforations
- special designs with metal eyelets, trip foil strips, special markings etc.

Siegling Proposition timing belts

Siegling Proposition timing belts are produced from top-quality polyurethane with embedded tension members made of steel cord or Kevlar. Thanks to their low mass and extreme tensile strength, they are quiet to operate and require almost no maintenance. These characteristics make them ideal for demanding tasks like accelerating and braking, as well as for exact positioning.

A wide range of coatings, patterns and profiles can be applied to standard timing belts. They can be custom-adapted for conveying and processing jobs by adding perforations, or by milling and grinding.

Coatings

There's a choice of over 30 standard materials for use in filling and packaging machinery. Coatings can provide the following added value:

- improved release characteristics due to better grip
- protection of sensitive products due to coatings' oft surfaces
- better food safety due to FDA compliance

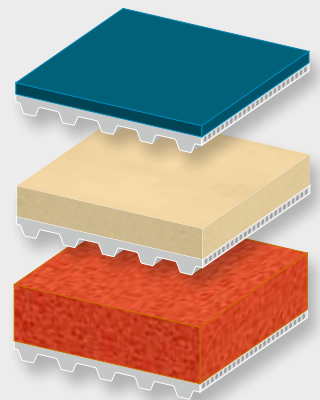

Cams and profiles

Cams and profiles help to produce innovative designs. In addition to numerous standard cams made of semi-finished products, any special types can be made using injection moulding techniques.

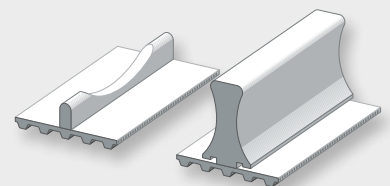

Mechanical processing

Timing belts and coatings can be milled, ground and punched with precise tolerances for special tasks.

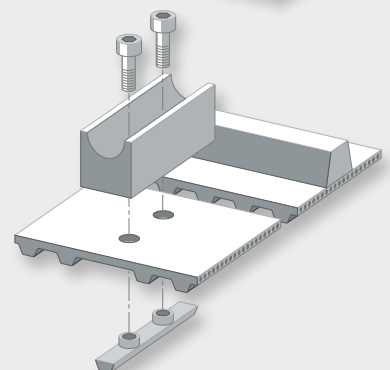

You can find detailed information about this range in our **Siegling Proposition timing belts** brochure (ref. no. 245).

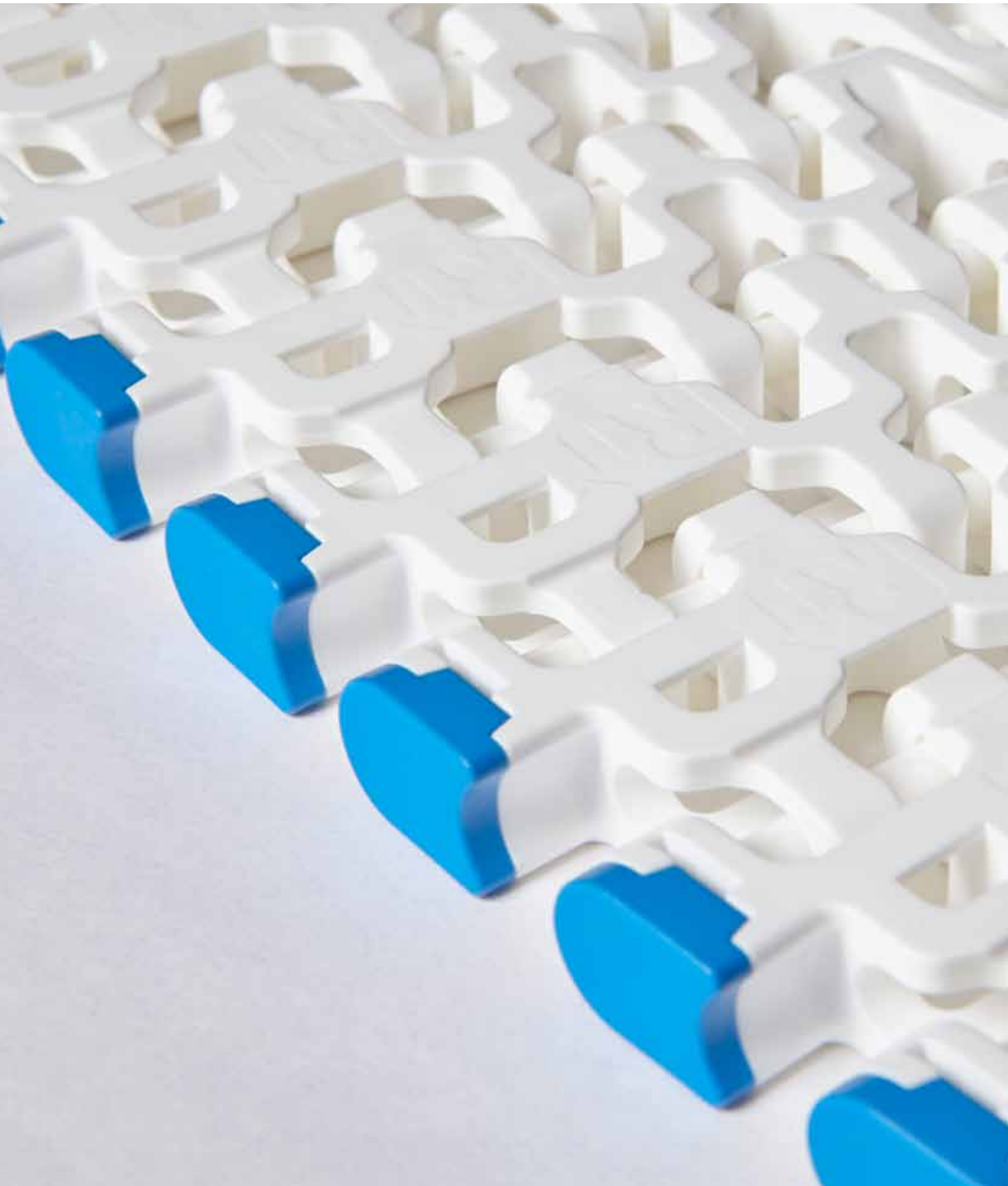



siegling prolink
modular belts

SIEGLING PROLINK

... are plastic modular belts made of homogeneous materials that are often superb combinations in conveying and processing. Diverse designs, pitches, patterns and open areas tap into a wide range of uses in food processing.



In terms of feedstock and migration figures, Siegling Prolink modular belts made of PE, PP, POM and PA types comply with the most important standard provisions and regulations (see symbols on the left). All Siegling POM Prolink modular belts are certified for compliance with the Halal regulations by IFRC Asian (member of the World Halal Council).

The characteristics

FDA-, EU- and Halal-compliant
(depending on type)

homogeneous material

robust

open design

resistant to decay

easy to fit

form-fit drive

The advantages

▶ all types are suitable
for direct contact with food

▶ resistant to cuts and incisions

▶ operate even under extreme conditions

▶ easy to clean, drainage possible

▶ long service lives

▶ save time and money

▶ no creep, reliable tracking



WHAT **SIEGLING PROLINK** CAN DO FOR YOUR HACCP CONCEPT

Siegling Prolink plastic modular belts offer built-in hygiene thanks to fully closed surfaces and homogeneous materials that are EU-, FDA- and NSF-approved. Series 4.1, 6.1 and 10 in particular support your HACCP concept with further hygiene-friendly characteristics.

- easy-clean design with wide channels on the bottom of the modules
- excellent resistance to hydrolysis
- good release properties
- they come in blue as a strong color contrast

Fewer areas where contamination can occur

Large radii, wide hinge eyelets and perfectly fitted hinge pins don't leave contamination and soiling to chance. (Figure: Prolink series 6.1)



Quick and easy to clean

On the returns, the lengthways and crosswise hinges provide openings for rinsing. On the underside, continuous channels without any annoying ribs make cleaning effective. (Figure: Prolink series 6.1)

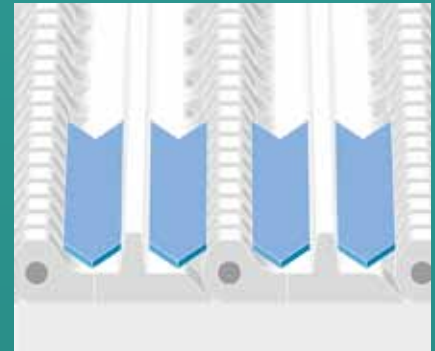

Incision-proof surfaces

POM-CR modules are exceptionally incision-proof and resistant to impact. This minimises the risk of grooves forming and delamination. (Figure: Prolink series 6.1)

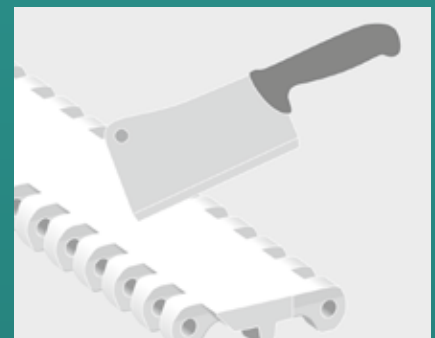

SIEGLING PROLINK

APPLICATION-DRIVEN DETAILS



Patterns/grips

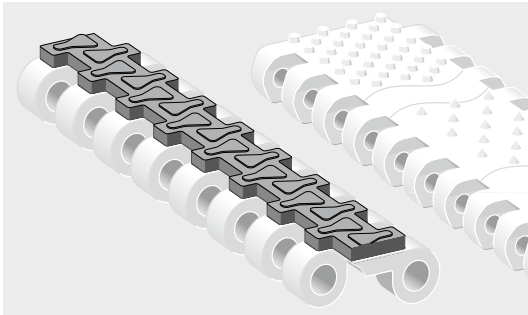

Secure grip is vital during inclined and stop-and-go conveying. Which is why Prolink modules come with patterns and grips to suit the consistency of the product conveyed. There's a choice of nub tops, pointed studs and Friction Top inserts.

Profiles and side guards

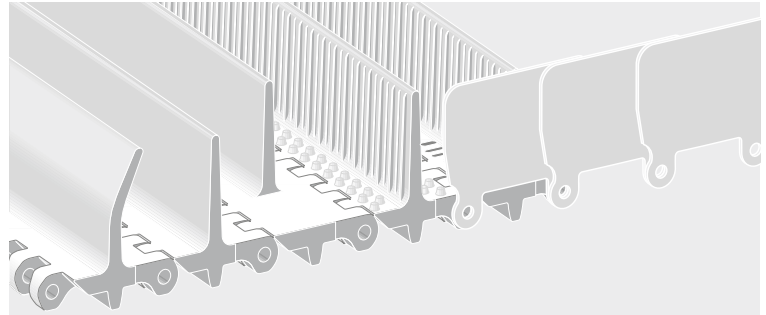

Profile modules enhance inclined and steep conveying of bulk goods and small products. Profiles are available in various shapes and dimensions. Special non-slip finishes (NCL) improve release of moist and sticky products. Side guards at different heights can be applied to contain products at the sides.

Spiral towers

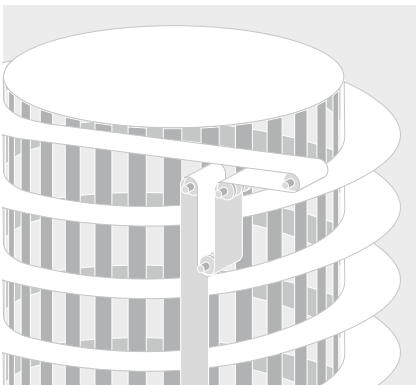

Curved belts with open areas are always used in spiral towers in order to convey baked goods, meat, poultry reliably during cooling, freezing or cooking processes. Special Prolink side modules make sure the system runs very quietly.

Little space required



Siegling Prolink combo belts combine the strength of the popular Prolink series 5 ST with the very small curved radius of series 11. Combo belts enable exceptionally space-saving, high-performance conveyor layouts.

Small return radii

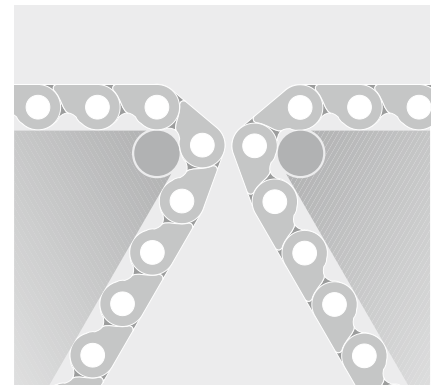

Transferring small items from one area to the next is highly critical. Siegling Prolink allows return radii of just 3 mm (series 13).

SIEGLING PROLINK FOOD PRODUCT RANGE

Application	Belt types
<p>Series 1 Straight running belts Pitch 50 mm (2 in)*</p> <p>Belts for medium to heavy-duty industrial conveying applications</p>	<p>S1-0 FLT Closed, smooth surface S1-0 NSK Closed, anti-skid pattern S1-0 FRT1 Closed, friction top S1-18 FLT Open (18%), smooth surface</p>
<p>Series 2 Straight running belts Pitch 25 mm (1 in)*</p> <p>Belts for light-duty food and container handling applications</p>	<p>S2-0 FLT Closed, smooth surface S2-0 FRT1 Closed, friction top S2-12 FLT Open (12%), smooth surface S2-57 GRT Open (57%), grid top surface S2-57 RRB Open (57%), raised ribs for transfer processes</p>
<p>Series 3 Straight running belts Pitch 50 mm (2 in)*</p> <p>Belts for medium-duty food applications</p>	<p>S3-0 FLT Closed, smooth surface S3-0 LRB Closed, with lateral ribbing S3-16 FLT Open (16%), smooth surface S3-16 LRB Open (16%), with lateral ribbing</p>
<p> ¹⁾ Series 4.1 Straight running belts Pitch 14 mm (0.55 in)*</p> <p>Belts for light to medium-duty food and non-food applications</p>	<p>S4.1-0 FLT Closed, smooth surface S4.1-0 NPY Closed, with negativ pyramid pattern S4.1-0 FRT1 Closed, friction top S4.1-21 FLT Open (21%), smooth surface S4.1-21 NTP Open (21%), with round studs</p>
<p> ¹⁾ Series 6.1 Straight running belts Pitch 50 mm (2 in)*</p> <p>Belts for medium to heavy-duty, hygiene-critical applications</p>	<p>S6.1-0 FLT Closed, smooth surface S6.1-0 NTP Closed, with round studs S6.1-0 CTP Closed, with pointed studs S6.1-21 FLT Open (21%), smooth surface S6.1-23 FLT Open (23%), smooth surface S6.1-36 FLT Open (36%), smooth surface</p>



¹⁾ NSF-compliant from these certified Forbo plants:
Huntersville (USA), Maharashtra (India), Malacky (Slovakia), NSW (Australia), Pinghu (China), Saint-Petersburg (Russia), Shizuoka (Japan), Tlalnepanitla (Mexico)

SIEGLING PROLINK FOOD PRODUCT RANGE

Application	Belt types
<p>Series 8 Straight running belts Pitch 25.4 mm (1 in)</p> <p>Belts for medium to heavy-duty applications</p>	<p>S8-0 FLT Closed, smooth surface S8-0 SRS Closed, slip-resistant surface S8-0 NSK Closed, anti-skid pattern S8-0 FRT1 Closed, friction top S8-0 RTP A90 Closed surface, with roller top S8-25 RAT Open (25 %) surface with rounded contact surfaces S8.1-30 FLT Open (30 %) flat top surface with rounded hinges for improved cleanability</p>
<p> Series 10 Straight running belts Pitch 25.4 mm (1 in)</p> <p>Belts for light to medium-duty hygiene-critical applications</p>	<p>S10-0 FLT Closed, smooth surface S10-0 NTP Closed, with round studs S10-0 FRT1 Closed, friction top S10-22 FLT Open (22 %), smooth surface S10-36 FLT Open (36 %), smooth surface S10-36 LRB Open (36 %), with lateral ribbing</p>
<p> Series 13 Straight running belts Pitch 8 mm (0.31 in)</p> <p>Belts for light-duty food and non-food nose bar applications</p>	<p>S13-0 FLT Closed, smooth surface S13-0 NPY Closed, with negativ pyramid pattern S13-0 CTP Closed surface and pointed studs S13-34 FLT Open (34 %), smooth surface</p>
<p> Series 14 Straight running belts Pitch 12.7 mm (0.5 in)</p> <p>Belts for medium-duty food and non-food applications</p>	<p>S14-0 FLT Closed, smooth surface S14-25 FLT Open (25 %), smooth surface S14-25 CUT Open (25 %) surface with curve top surface S14-25 FRT1 Open (25 %), friction top</p>
<p> Series 15 Straight running belts Pitch 12.7 mm (0.5 in)</p> <p>Belt for light-duty food applications utilizing 12.7 mm (0.5 in) nose bars</p>	<p>S15-47 GRT Open (47 %), lattice-shaped surface S15-47 RSA Open (47 %), lattice-shaped surface with reduced surface area</p>

¹⁾ NSF-compliant from these certified Forbo plants:
 Huntersville (USA), Maharashtra (India), Malacky (Slovakia), NSW (Australia), Pinghu (China), Saint-Petersburg (Russia), Shizuoka (Japan), Tlalnepantla (Mexico)

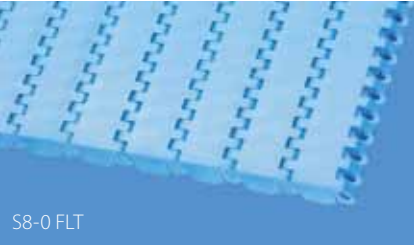
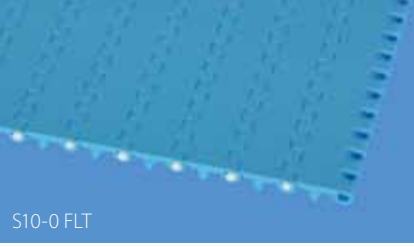

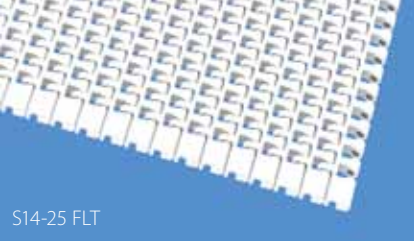
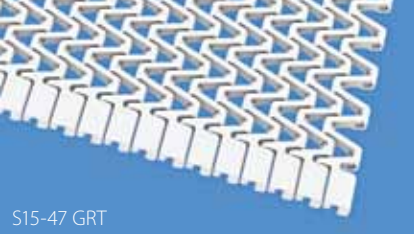
	Materials**	Colors (standard)**	Pitch [mm (in)]*
 <p>S8-0 FLT</p>	PP, PP (R7), POM, POM (R6), POM-CR, PA-HT	AT, BL, BL (BK), BK, LG, LG (BK), WT, YL	25.4 (1)
 <p>S10-0 FLT</p>	PE, PE-MD, PP, PP-MD, POM, POM-MD, PA***	BL, LB, WT	25.4 (1)
 <p>S13-0 FLT</p>	POM, PA***	BL, WT	8 (0.31)
 <p>S14-25 FLT</p>	PE, PP, POM	BL, WT	12.7 (0.5)
 <p>S15-47 GRT</p>	PP, POM, PA***	BL, WT	12.7 (0.5)

* All imperial measurements have been rounded up.

** Not all materials are available in all colors.

*** Values valid for dry applications (RH <50%). Belts in PA material will absorb water in wet environments, causing them to expand and reduce the nominal belt pull capacity.

Surface pattern

CTP	=	Cone top
CUT	=	Curved top
FLT	=	Flat top (smooth)
FRT(X)	=	Friction top (Design X)
GRT	=	Grid top
LRB	=	Lateral rib
NPY	=	Negativ pyramid
NSK	=	Non skid
NTP	=	Nub top (round studs)
RAT	=	Radius top
RSA	=	Reduced surface area
RTP	=	Roller top
RRB	=	Raised rib
SRS	=	Slip-resistant surface

Style

2.2	=	2.2 collapse factor
2.2 G	=	2.2 collapse factor, guided
F2 – F8	=	Collapse factor modules
HD	=	Hold Down
G	=	Guided
RG	=	Reversed guided
ST	=	Strong (S5)

Material

PA	=	Polyamide
PA-HT	=	PA high temperature
PE	=	Polyethylene
PE-MD	=	PE metal detectable
POM	=	Polyoxymethylene (Polyacetal)
POM-CR	=	POM cut resistant
POM-MD	=	POM metal detectable
PP	=	Polypropylene
PP-MD	=	PP metal detectable
R4	=	TPE 86 Shore A, PP
R6	=	TPE 63 Shore A, POM
R7	=	TPE 50 Shore A, PP
R8	=	TPE 55 Shore A, PE
TPC1	=	Thermoplastic Copolyester

Color





AT	=	Anthracite
BG	=	Beige
BL	=	Blue
BK	=	Black
DB	=	Dark blue
LB	=	Light blue
LG	=	Light gray
UC	=	Uncolored
WT	=	White
YL	=	Yellow

SIEGLING PROLINK

FOOD PRODUCT RANGE

Application	Belt types
<p>Series 5 Side flexing and spiral belts Pitch 25 mm (1 in)*</p> <p>Belts for light to medium-duty food and non-food applications</p>	<p>S5-45 GRT Open (45%), lattice shaped S5-45 NTP Open (45%), lattice shaped with high round studs S5-45 GRT G Open (45%), lattice shaped, guided S5-45 GRT RG Open (45%), lattice shaped, reversed guided S5-45 GRT ST Reinforced type, open (45%), lattice shaped S5-39 FRT1 Open (39%), lattice shaped, friction top, raised S5-33 FRT2 Open (33% for full FRT2 surface area), lattice shaped, friction top, flat</p>
<p>Series 9 Side flexing and spiral belts Pitch 50 mm (2 in)*</p> <p>Belts for medium to heavy-duty food and non-food applications</p>	<p>S9-57 GRT Open (57%), lattice shaped S9-57 NTP Open (57%), lattice shaped with round studs S9-57 GRT G Open (57%), lattice shaped, guided S9-57 GRT Longer side modules, open (57%), lattice shaped F2, F3, F4, Collapse factor modules F5, F6, F7, F8</p>
<p>Series 11 Side flexing and spiral belts Pitch 25 mm (1 in)*</p> <p>Belts for light-duty food and non-food applications</p>	<p>S11-45 GRT Open (45%), lattice-shaped, with replaceable caps S11-45 GRT HD Open (45%), lattice-shaped, with replaceable Hold Down caps S11-33 FRT2 Open (33% for full FRT2 surface area), lattice-shaped, friction top, flat</p>
<p>Series 18 Side flexing and spiral belts Pitch 25.4 mm (1 in)*</p> <p>Belts for light to medium-duty food and non-food applications</p>	<p>S18-44 GRT 2.2 Open (44%), lattice-shaped surface S18-44 GRT 2.2 G Open (44%), lattice-shaped surface and Hold Down Tabs</p>

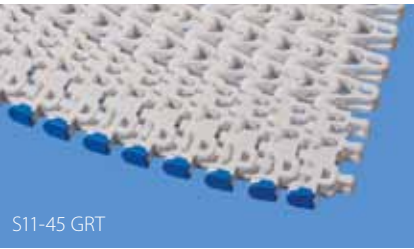

	Materials**	Colors (standard)**	Pitch [mm (in)]*
 <p>S5-45 GRT</p>	PE, PP, PP (R4), PP (R7), POM-CR, PA***	BL, BL (BG), BL (BK), DB, WT, WT (BG)	25 (1)
 <p>S9-57 GRT</p>	PE, PP, POM, POM-CR, PA***	BL, DB, LG, UC, WT	50 (2)
 <p>S11-45 GRT</p>	PP, PP (R7), POM-CR, PA***	WT, WT (BG), BL, BL (BG)	25 (1)
 <p>S18-44 GRT 2.2 G</p>	PP, POM-CR	WT, BL	25.4 (1)

* All imperial measurements have been rounded up.

** Not all materials are available in all colors.

*** Values valid for dry applications (RH <50%). Belts in PA material will absorb water in wet environments, causing them to expand and reduce the nominal belt pull capacity.

Surface pattern

CTP	=	Cone top
CUT	=	Curved top
FLT	=	Flat top (smooth)
FRT(X)	=	Friction top (Design X)
GRT	=	Grid top
LRB	=	Lateral rib
NPY	=	Negativ pyramid
NSK	=	Non skid
NTP	=	Nub top (round studs)
RAT	=	Radius top
RSA	=	Reduced surface area
RTP	=	Roller top
RRB	=	Raised rib
SRS	=	Slip-resistant surface

Style

2.2	=	2.2 collapse factor
2.2 G	=	2.2 collapse factor, guided
F2 – F8	=	Collapse factor modules
HD	=	Hold Down
G	=	Guided
RG	=	Reversed guided
ST	=	Strong (S5)

Material

PA	=	Polyamide
PA-HT	=	PA high temperature
PE	=	Polyethylene
PE-MD	=	PE metal detectable
POM	=	Polyoxymethylene (Polyacetal)
POM-CR	=	POM cut resistant
POM-MD	=	POM metal detectable
PP	=	Polypropylene
PP-MD	=	PP metal detectable
R4	=	TPE 86 Shore A, PP
R6	=	TPE 63 Shore A, POM
R7	=	TPE 50 Shore A, PP
R8	=	TPE 55 Shore A, PE
TPC1	=	Thermoplastic Copolyester

Color

AT	=	Anthracite
BG	=	Beige
BL	=	Blue
BK	=	Black
DB	=	Dark blue
LB	=	Light blue
LG	=	Light gray
UC	=	Uncolored
WT	=	White
YL	=	Yellow

Siegling – total belting solutions

Committed staff, quality oriented organization and production processes ensure the constantly high standards of our products and services.

Forbo Movement Systems complies with total quality management principles. Our quality management system has ISO 9001 certification at all production and fabrication sites. What's more, many sites have ISO 14001 environmental management certification.



Ref. no. 269-2
10/20 - UDH - Reproduction of text or parts thereof only with our approval. Subject to change.



Forbo Siegling service – anytime, anywhere

The Forbo Siegling Group employs around 2,400 people. Our products are manufactured in ten production facilities across the world. You can find companies and agencies with warehouses and workshops in over 80 countries. Forbo Siegling service points are located in more than 300 places worldwide.

Forbo Siegling GmbH

Lilienthalstrasse 6/8, D-30179 Hannover

Phone +49 511 6704 0

www.forbo-siegling.com, siegling@forbo.com



MOVEMENT SYSTEMS