

Logistics Material Handling

weldable elastic monolithic conveyor belts and belt profiles for intralogistics



CONTENT

- 03 Introduction
- 04 „Material Handling“:
Applications, product requirements and solutions
- 06 Product groups of BEHAbelt
- 07 Features of monolithic conveyor belts
- 08 Features of belt profiles
- 09 Product information of monolithic conveyor belts
- 10 Product information of belt profiles
- 12 Welding technology
- 13 Technical information
- 15 Service
- 16 Get your samples

smart conveying: logistics – an industry in motion

The range of different application types in intralogistics is very extensive. In order that the individual processes can be coordinated in the best possible way, BEHAbelt offers versatile solutions for the requirements of material handling.

Our product solutions reach from classic round and V-belts to elastic monolithic conveyor belts. The suitable welding technology allows you to minimize downtimes quickly and cost-savings, even on site.



ADVANTAGES

ONE-STOP SHOP

As a manufacturer of these products, we are able to individually manufacture the appropriate product solution even for special application requirements.

Due to our in-house tool shop and the large number of available material and design variants, we are always able to manufacture and develop the most suitable product for you.

COMPETENCE AND EXPERIENCE

Our decades of experience are the key to our comprehensive consulting expertise. Belts and belt profiles from BEHAbelt have been used successfully for years in intralogistics and packaging machines worldwide.

FOR YOUR APPLICATIONS

BEHAbelt offers product solutions for most drive and conveyor systems in intralogistics, such as

APPLICATIONS

- Roller conveyor
- Inclined conveyors
- Cross conveyor
- Curved conveyor
- Check weigher
- Labelling systems
- Packaging machines
- Inward and outward transfer
- Sorting conveyors
- etc.

Belt profiles for your application



Roller to roller drive



Tangential drive

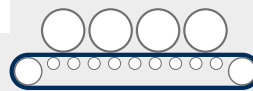

Crossed drive/
Central drive shaft



TYPICAL APPLICATIONS WITH BELT PROFILES

Application	Product group	Geometries	Surfaces	Hardness Shore	Characteristics	Welding tools
<ul style="list-style-type: none"> · Roller to roller drive · Central drive shaft · Tangential drive 	Round belts	$\varnothing = 2 \dots 20 \text{ mm}$	smooth and rough	80, 84, 88, 92 A	Antistatic PU Plus temperature flexibility	EErgo & FZ RS02
<ul style="list-style-type: none"> · Tangential drive · Roller conveyor, straight and curves 	V-belts	13x8...32x20 mm	smooth	80, 84, 88, 92 A	Antistatic PU Plus temperature flexibility	EErgo & FZ RS02 HP01
<ul style="list-style-type: none"> · Roller to roller drive, straight and curves 	Poly-V	PJ2, PJ3, PJ4	smooth	80, 88 A		EErgo & FZ
<ul style="list-style-type: none"> · Central drive shaft · Roll to roll drive 	Twisted round belts	$\varnothing = 2 \times 3 \text{ mm}$ ($\varnothing = 5,0 \text{ mm}$)	smooth and rough	76, 80 A	PU Plus	Hook connectors
<ul style="list-style-type: none"> · Central drive shaft · Roller to roller drive 	Hollow round belts	$\varnothing = 4,8/6,3/8/9,5/12,5/15 \text{ mm}$	smooth	80, 88, 90 A		Nipple connectors EErgo & FZ

ROLLER CONVEYORS

In the logistics industry, roller conveyors have a prevalent position; they can be found in almost every process area. This includes our BEHAbelt tangential belt Bluepower as well as our special low stretch material compound PUplus, which are designed for dimensional stability and high load and torque absorption.

For roller-to-roller drives we also offer round belts as well as a unique Poly-V solution, which can also be joined quickly and easily on site to keep downtime to a minimum.

CALCULATIONS

On pages 13 and 14 you will find some helpful formulas and remarks on the topics of design, groove geometry, pretension or belt length calculation.

MAINTENANCE / OPTIMIZATION

To avoid long downtimes, the use of weldable elastic belt profiles offers considerable advantages. With our professional welding technology, you can replace roller conveyor belts quickly and easily.

As an alternative, there are two types with mechanical quick-connections: hook belts or hollow round belts. This end connection is made without welding and therefore does not require trained worker.

In general, the design with tangential drives results in energy savings and thus lower energy costs. Furthermore, the correct design of the belt profiles can optimise the system and also save energy.

Conveyor belts for your application



Belt conveyor



Crossed drive/
Central drive shaft



TYPICAL APPLICATIONS WITH BELTS

Application	Product group	Band width x thickness	Surface	Hardness Shore	Characteristics	Welding tools
· Central drive shaft	Flat belts	10...15 mm x 1,0...2,0 mm	SR / FI	80, 84, 95 A		EErgo & FZ02/3F
· Sorting conveyors · In-/Outfeed-System · Inclined/declined	elastic monolithic conveyor belts	750x1,0...4,0 mm	SR / LGB / SM	80, 84, 95 A		FZ02/3F, HS400/800
· Check weighers	elastic monolithic conveyor belts	750x0,9 mm	SM	80, 84, 95 A		HS400/800
· Inclined/declined	elastic monolithic conveyor belts	750x1,0...4,0 mm	SR / LGB / SM	80, 84, 95 A	2C-Technology	HS400/800

CONVEYOR LINES

Even basic conveying functions require numerous different belt properties, for different materials to be conveyed, conveying speeds, deflection cards, stop & go and accumulation operation as well as other operating conditions BEHAbelt supplies optimally designed product solutions.

INCLINED CONVEYOR

Conveyed goods can be transported at an angle even with smooth belt surfaces. The conveying angles that can be realized here depend on the nature of the material to be conveyed, the coating on the carrying side and the external influences such as dust, humidity, etc. For larger conveying angles and the conveying of small parts and bulk materials, BEHAbelt supplies structured or cross-profiled conveyor belts.

Elastic belts in intralogistics reduce the costs of system design, as tensioning stations are largely unnecessary. Depending on the material to be conveyed or the type of conveyor (e.g. accumulation or inclined conveyor), a wide variety of belt types are required. With BEHAbelt's new 2-component design, 2 different degrees of shore hardness can be combined in one belt. If a belt for inclined conveying is required, the conveying side can have high grip, while the running side has low friction.

CROSSBELT SORTER

Crossbelt sorters generally require very thin and flexible belts whose surfaces have high coefficients of friction. High coefficients of friction on the carrying side guarantee precise transfer to the sorter. In cross belt sorters, the high acceleration requires extremely good friction coefficients of the belt surface. BEHAbelt offers belts with a thickness of 0.9 mm and more.

Overview product portfolio

**ELASTIC MONOLITHIC
CONVEYOR BELTS**



**V-RIBBED BELT
POLY-V**



V-BELTS

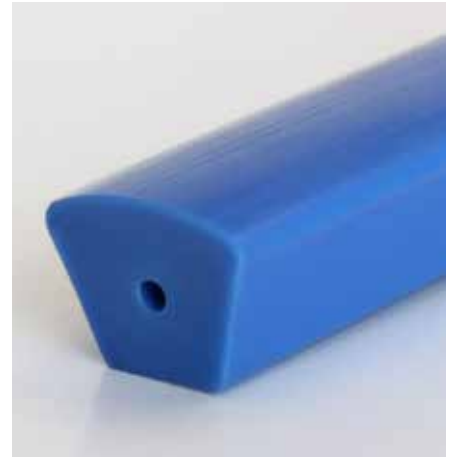

ROUND BELTS



TWISTED ROUND BELTS



HOLLOW ROUND BELTS



**BELT GUIDE:
V-GUIDES**

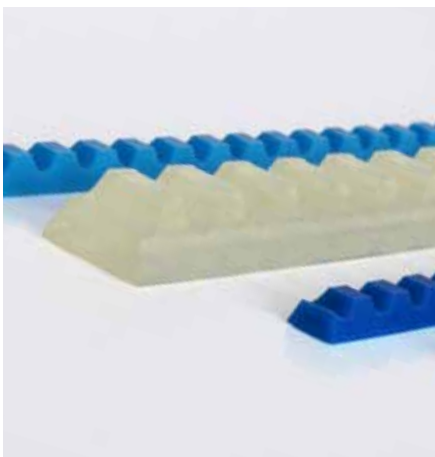

**BELT GUIDE:
BELT EDGES**

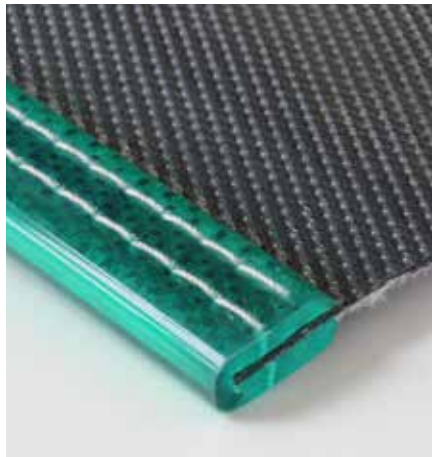

WELDING TECHNOLOGY



Elastic monolithic conveyor belts

2C

BELT CONSTRUCTION AND CHARACTERISTICS

Monolithic conveyor belts are extruded homogeneously and do not consist of several layers that are connected to each other. Layer separation or the detachment of coating particles are therefore impossible.

Materials and designs are selected to cover a wide range of characteristics, such as wear and chemical resistance.

Special features like antistatic dissipation, UV resistance, cold flexibility or hydrolysis resistance can be added by using additives in the manufacturing process.

Belt constructions of BEHAbelt can be manufactured in one or two layers (2C-technology) in order to combine different product requirements on the top and bottom side of the conveyor belt optimally.

A well arranged selection of the belt surface ensures a safe transport of the products. Because of the large selection of belt surfaces and belt structures, perfect functioning can also be guaranteed for specific process sections.

2C-TECHNOLOGY

BEHAbelt additionally offers belts consisting of 2 components. Depending on the material to be conveyed or the type of conveyor (e.g. accumulation or inclined conveyor), a wide variety of belt types are required. With BEHAbelt's new 2-component design, 2 different degrees of shore hardness can be combined in one belt. If a belt for inclined conveying is required, the conveying side can have high grip, while the running side has low friction.

ON-SITE WELDING

Elastic monolithic belts are easy and quick to weld endlessly. This is done by means of a conventional butt splice, which can be carried out on site. For this we offer the corresponding welding set HS400 or HS800 (see page 12).

PRODUCT ADVANTAGES

Perfect for your application

- Material thicknesses from 0.9 - 4 mm
- Large selection of different surface structures, e.g. good grip qualities, low friction
- Useful special features, e.g. antistatic or hydrolysis resistant, flexible at low temperatures

Process safety

- High abrasion and wear resistance
- Safety and reliability
- Impact resistant
- Especially low noise
- Less downtime
- Easy and quick to weld



Weldable belt profiles

BELT MATERIALS AND CHARACTERISTICS

For the manufacturing of belt profiles BEHAbelt works with high quality PU and TPE materials which guarantee an optimal performance and a long service life in conveyor technology and drive applications. On the one hand they are resistant to oil, grease or chemical agents and on the other hand they are resistant to hydrolysis.

The extruded belts are available in various Shore hardnesses and diameters. Depending on the requirements, they are reinforced with a tensile member and thus increase the tensile load and tensile strength.

Both PU and TPE belt profiles are easy to weld. BEHAbelt delivers the belts either endlessly welded to your desired length or the belts can be welded independently on site.

The loss of time when changing profiles in the conveyor system is very low due to the use of elastic belt profiles. The welding with a welding paddle is carried out without any problems and the elasticity saves an additional tensioning aid during installation.



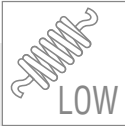

PU plus

is a special material composition for elevated load capacity and reduced elongation with the same product design and unchanged pulley diameters, compared to products made of standard PU compounds.

As standard, PU Plus is offered for Poly-V, round belts and twisted round belts.



PU plus V-ribbed belts

Elastic BEHAbelt PUplus V-ribbed belts PJ offer a powerful power transmission for linear and curved conveyors in the light load range up to approx. 50 kg.

The special material mixture PUplus provides an optimal compromise between tensile strength and elasticity.

Advantages for installation / belt replacement

- Thanks to the elasticity, installation and belt replacement are simple and time-saving.
- Each length can be produced independently on site with a welding paddle and guide clamp.
- On request, endless belts can be manufactured.

Advantages for system design

- Weldable belts by the meter allow individual lengths.
- Better behaviour in conveying curves (inclined running-in).

Advantages for safety

- Reduction of the risk of injury:
 - in case of belt retraction during operation
 - when replacing the belt, thanks to the force-saving installation







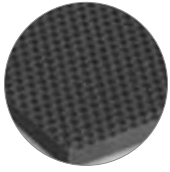



Conveyor belts for logistics

MORE BELTS IN OUR
PRODUCT PORTFOLIO

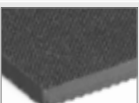

BOTTOM SIDE: FABRIC IMPRESSION (FI), WIDTH 750 mm

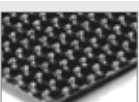

Top side	Colour	Features	Quality	Hardness Shore	Profile thickness		Weight per m ² approx. kg	Recommended Min. pulley Ø		Pull force for k1% pretension		Standard roll		Recommended pretension	Order No.
					mm	inch		mm	inch	N/mm	lbs/inch	m	ft		
 smooth matt (SM)			PU75A	80 A	1,6	1/16	1,92	15	0,60	0,24	1,35	50	164	1-5%	FBFI750X16SB
 slightly rough (SR)			PU80A	84 A	1,2	3/64	1,44	10	0,40	0,25	1,40	50	164	1-5%	FBFJ750X12SB
					1,6	1/16	1,92	15	0,60	0,32	1,80	50	164	1-5%	FBFJ750X16SB
 Longitudinal (LGB)			PU80A PU65A	84 A 72 A	2,2	1/24	1,44	18	0,71	0,28	1,58	50	164	1-5%	FBFGJ750X22S
 rough impression (RI)			PU80	84A	2,0	5/64	2,4	20	0,8	0,40	2,25	50	164	1-5%	FBFJ750X20SJ

COEFFICIENT OF FRICTION μ_{dyn} FOR FLAT BELT SURFACES ON STEEL (DRY)

Quality	smooth gloss (SG)	smooth matt (SM)	fabric impression (FI)	rough impression (RI)	Inverted diamond (ID)	Slightly rough (SR)
PU65A	0,85	0,80	0,65	0,60	0,65	0,65
PU75A	0,70	0,65	0,55	0,50	0,55	0,55
PU80A	0,65	0,60	0,45	0,40	0,45	0,45
PU95A	0,45	0,40	0,25	0,20	0,25	0,25

Please consider a coefficient of friction of $\mu = 0.15$ for a roller conveyor support.

One-stop shop for belt accessories

NOTECHED V-GUIDES / GUIDE PROFILES



Weldable V-guides are often used as guide profiles on the running side in order to support the straight running of e.g. short or under-square conveyor belts or to absorb cross forces in case of sidewise product feeding.

BELT EDGES FOR CURVED CONVEYORS

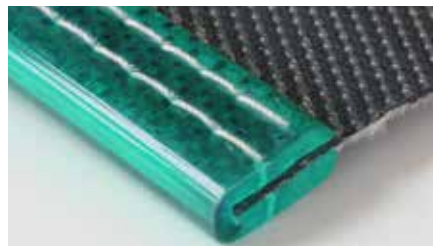

Belt edges for stabilising and guidance of curved belts. Belt edges are usually applied by sewing and/or gluing.

GUIDE PROFILE ROUND/SMOOTH Ø 5x9 mm

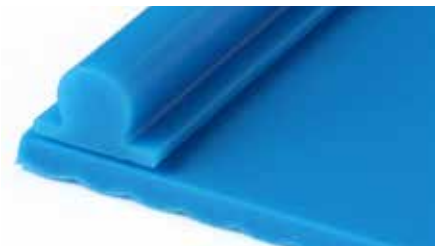

Special weld-on profile for guiding conveyor belts. The special feature here is the geometry of a 5mm round belt, which fits exactly into the groove of roller conveyors.

Belt profiles for logistics

V-RIBBED BELTS

PU75A plus



80° Shore A

Order No.	Geometry mm	Recomm. Min. pulley-∅		Fmax/belt (Standard)	
		mm	inch	kg	lbs
FBPVIPJ20	4,8 x 4	30	1,2	7,2	15,8
FBPVIPJ30	7 x 4	30	1,2	10,5	23,1
FBPVIPJ40	9,3 x 4	30	1,2	14,4	31,7

Recommended pretension: 3...6 %
Coefficient of friction μ : Steel: 0,70; PE: 0,40; HDPE: 0,35

PU85A plus



88° Shore A

Order No.	Geometry mm	Recomm. Min. pulley-∅		Fmax/belt (Standard)	
		mm	inch	kg	lbs
FBPVKPJ2L	4,8 x 4	40	1,6	10,3	22,7
FBPVKPJ3L	7 x 4	40	1,6	15,0	33,1
FBPVKPJ4L	9,3 x 4	40	1,2	20,6	45,4

Recommended pretension: 3...6 %
Coefficient of friction μ : Steel: 0,60; PE: 0,30; HDPE: 0,25

V-BELTS

TPE55D / VAULTED TOP



55° Shore D / 100° Shore A

Order No.	Geometry mm	Recomm. Min. pulley-∅		Fmax/belt (Standard)	
		mm	inch	kg	lbs
FBKBLP17113W	17 x 11,3	175	7,0	119,2	262,2

 also available with polyester reinforcement

Recommended pretension: 2...4 %
Coefficient of friction μ : Steel: 0,35; PE: 0,20; HDPE: 0,15

TPE55D / WITH CHAMFER



55° Shore D / 100° Shore A

Order No.	Geometry mm	Recomm. Min. pulley-∅		Fmax/belt (Standard)	
		mm	inch	kg	lbs
FBKH55D17115	17 x 11,4	175	7,0	116,0	255,2

 also available with polyester reinforcement

Recommended pretension: 2...4 %
Coefficient of friction μ : Steel: 0,35; PE: 0,20; HDPE: 0,15

PU75A smooth



80° Shore A

Order No.	Geometry mm	Recomm. Min. pulley-∅		Fmax/belt (Standard)	
		mm	inch	kg	lbs
FBKP75A17	17 x 11 (B)	100	3,9	37,2	81,9
FBKP75A22	22 x 14 (C)	145	5,7	60,8	133,7

Recommended pretension: 4...8 %
Coefficient of friction μ : Steel: 0,70; PE: 0,40; HDPE: 0,35



TWISTED ROUND BELTS

PU75A plus smooth (matt)



80° Shore A

Order No.	Diameter ∅	Recomm. Min. pulley-∅		Fmax/belt (Standard)	
		mm	inch	kg	lbs
FBX13X2500G	5,0	40	1,6	5,9	13,0

available standard lengths of 250 - 710 mm

Recommended pretension: 6...8 %
Coefficient of friction μ : Steel: 0,70

PU70A smooth



76° Shore A

Order No.	Diameter ∅	Recomm. Min. pulley-∅		Fmax/belt (Standard)	
		mm	inch	kg	lbs
FBXH3X250LG	5,0	40	1,6	2,6	5,8

available standard lengths of 250 - 710 mm

Recommended pretension: 8...10 %
Coefficient of friction μ : Steel: 0,75

ROUND BELTS



PU75A smooth



Order No.	Diameter ∅	Recomm. Min. pulley-∅		Fmax/belt (Standard)	
		mm	inch	kg	lbs
FBRP75A040	4,0	30	1,2	3,1	6,8
FBRP75A050	5,0	40	1,6	4,9	10,8
FBRP75A060	6,0	50	2,0	7,3	16,1

Recommended pretension: 4...8 %
Coefficient of friction μ : Steel: 0,70; PE: 0,40; HDPE: 0,35

80° Shore A

PU75A plus matt



Order No.	Diameter ∅	Recomm. Min. pulley-∅		Fmax/belt (Standard)	
		mm	inch	kg	lbs
FBRI0400G	4,0	30	1,2	3,6	7,9
FBRI0500G	5,0	40	1,6	5,7	12,5
FBRI0600G	6,0	50	2,0	8,1	17,8

Recommended pretension: 3...6 %
Coefficient of friction μ : Steel: 0,70; PE: 0,40; HDPE: 0,35

80° Shore A

PU80A smooth



Order No.	Diameter ∅	Recomm. Min. pulley-∅		Fmax/belt (Standard)	
		mm	inch	kg	lbs
FBRP80A040TR	4,0	30	1,2	4,1	9,0
FBRP80A050TR	5,0	45	1,8	6,2	13,6
FBRP80A060TR	6,0	55	2,2	9,0	19,8

Recommended pretension: 4...8 %
Coefficient of friction μ : Steel: 0,65; PE: 0,35; HDPE: 0,30

84° Shore A

PU85A rough



Order No.	Diameter ∅	Recomm. Min. pulley-∅		Fmax/belt (Standard)	
		mm	inch	kg	lbs
FBRP85A040R	4,0	35	1,4	4,7	10,3
FBRP85A050R	5,0	50	2,0	7,1	15,7
FBRP85A060R	6,0	60	2,4	10,4	22,9

Recommended pretension: 4...8 %
Coefficient of friction μ : Steel: 0,45; PE: 0,30; HDPE: 0,25

88° Shore A

PU85A plus rough



Order No.	Diameter ∅	Recomm. Min. pulley-∅		Fmax/belt (Standard)	
		mm	inch	kg	lbs
FBRK040LR	4,0	35	1,4	5,3	11,6
FBRK050LR	5,0	50	2,0	8,1	17,8
FBRK060LR	6,0	60	2,4	11,7	25,6

Recommended pretension: 3...6 %
Coefficient of friction μ : Steel: 0,45; PE: 0,30; HDPE: 0,25

88° Shore A

HOLLOW ROUND BELTS



PU75A smooth



Order No.	Diameter ∅ mm	Recomm. Min. pulley-∅		Fmax/belt (Standard)	
		out/in	mm	inch	kg
FBHP75A048	4,8 / 1,8	30	1,2	3,7	8,1
FBHP75A063	6,3 / 2,5	45	1,8	6,7	14,7
FBHP75A080	8,0 / 3,2	55	2,2	10,8	23,8

Recommended pretension: 4...8 %
Coefficient of friction μ : Steel: 0,70; PE: 0,40; HDPE: 0,35

88° Shore A

PU85A rough



Order No.	Diameter ∅ mm	Recomm. Min. pulley-∅		Fmax/belt (Standard)	
		out/in	mm	inch	kg
FBHP85A048R	4,8 / 1,8	35	1,4	5,3	11,7
FBHP85A063R	6,3 / 2,5	55	2,2	9,4	20,6
FBHP85A080R	8,0 / 3,2	65	2,6	15,3	33,7

Recommended pretension: 4...8 %
Coefficient of friction μ : Steel: 0,45; PE: 0,35; HDPE: 0,30

88° Shore A

PU85A smooth



Order No.	Diameter ∅ mm	Recomm. Min. pulley-∅		Fmax/belt (Standard)	
		out/in	mm	inch	kg
FBHP85A048GE	4,8 / 1,8	35	1,4	5,3	11,7
FBHP85A063GE	6,3 / 2,5	55	2,2	9,4	20,6
FBHP85A080GE	8,0 / 3,2	65	2,6	15,3	33,7

Recommended pretension: 4...8 %
Coefficient of friction μ : Steel: 0,60; PE: 0,35; HDPE: 0,30

88° Shore A

Welding tools

FOR ON-SITE WELDING

FOR BELTS UP TO A WIDTH OF 800 mm

BEHAbelt has developed the welding tools **HS400** and **HS800** especially for butt welding of conveyor belts.

- HS400 for up to 400 mm belt width
- HS800 for up to 800 mm belt width
- Sophisticated design with positioning aids and stoppers ensures highly repeatable accuracy of weldings
- Clamping lever with locking device
- Exact temperature adjustment via control unit
- No adhesion of PU or TPE material due to Teflon-coated heating paddle



FOR BELT PROFILES AND FLAT BELT STRIPS UP TO A WIDTH OF 80 mm

The welding paddles BEHAbelt EErgo 60 and 90 have been especially designed for joining PU and TPE profiles and flat belt strips.

- EErgo 60 in combination with the guide clamp FZ01 Vario for butt welding of belt profiles
- EErgo 90 in combination with the guide clamp FZ02/3F for butt welding of flat belt strips up to a width of 80mm.
- Very fast heating time of approx. 5 minutes



FOR BELT PROFILES

Butt welds within seconds with the unique friction welding machine RS02 for PU profiles

- No long heating-up and set-up times, spliced within seconds.
- Precise pressure and automatical 0-positioning prevents uneven welds and premature failure.
- Automatic alignment ensures that the belt ends are aligned perfectly.
- Due to its small size the RS02 press can be used in confined spaces.



Calculations

CALCULATION OF BELT LENGTH

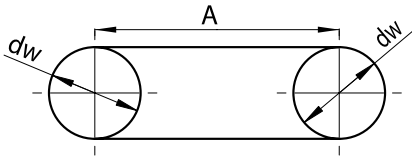

$$L_{f1} = dw \times \pi + 2 \times A$$

dw = effective diameter (position of the neutral fiber of belt)
 A = center distance
for round belts: dw = bottom of groove + diameter of belt

The recommended pretension has to be considered in addition!

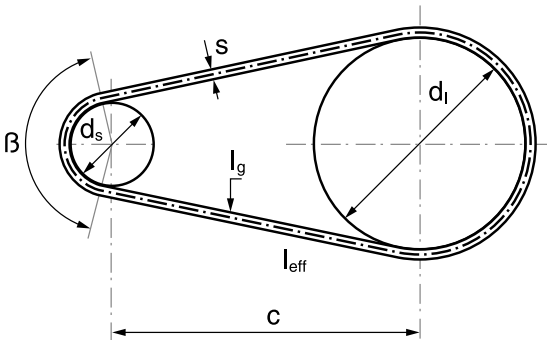

$$l_{eff} = 2c \cdot \sin\left(\frac{\beta}{2}\right) + \frac{\pi}{2} \left[d_s + d_i + 2s + \frac{(d_i - d_s)(180 - \beta)}{180} \right] \text{ [mm]}$$

$$\beta = 2 \arccos\left(\frac{d_i - d_s}{2c}\right) \text{ [}^\circ\text{]}$$

c = center distance [mm]
 ds = Diameter of the small pulley [mm]
 di = Diameter of the big pulley [mm]
 beta = Wrapping angle on small pulley

The recommended pretension has to be considered in addition!

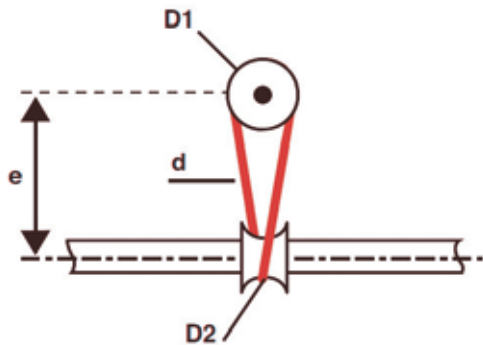

Lineshaft conveyor belts (semi-crossed)

$$L_{f3} = [(D1 + d) + (D2 + d)] \times \pi / 2 + 2 \times \sqrt{[(D1 + d)^2 / 4 + e^2]}$$

recomm. center to center distance (e): 4 x D1

D1 : pulley diameter at bottom of groove
 D2 : inner diameter of diabolo roller
 d : diameter of belt
 e : center distance

The recommended pretension has to be considered in addition

PULLEYS FOR ROUND BELTS

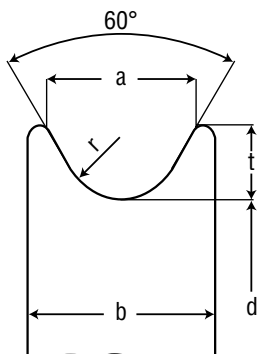

Belt \varnothing	2	3	4	4,8	5	6	6,3	7	8	9,5	10	12	12,5	15	18	20
a (mm)	4,5	5,5	7	8	8	10	10	11	12	14,5	15	18	18,5	23	28	30
b (mm)	6,5	8	10	12	12	14	14	15	16	19	19	22	23,0	27	32	36
t (mm)	2,5	3	3,5	4	4	5	5	5,5	6	7	7,5	9	9	12	14	15
r (mm)	1,4	1,9	2,5	3	3	3,5	3,5	4	4,5	5,5	5,5	6,5	7	8	9,5	11

Please select the appropriate minimum pulley diameter according to the different PU/Polyester qualities. The best qualified materials for pulleys are steel, high-alloyed steel, aluminium or Polyamid when it comes to plastic. Please keep in mind the low friction coefficient μ when using plastic material.

RECOMMENDED PULLEYS FOR V-BELTS

Profile according to DIN 2215	6	8	10	13	17	22	32
Global standard acc. to ISO 4184	Y	M	Z	A	B	C	D
Upper width b (mm)	6	8	10	13	17	22	32
Height h (mm)	4	5	6	8	11	14	20
Lower width u (mm)	3,3	4,55	5,9	7,5	9,4	12,35	18,25
Pulley angle α	$\angle 34 - 38^\circ$						
Groove width b1	6	8	10	13	17	22	32
	→ depending on how much the profile should stick out above the upper pulley edge						
Groove depth t (mm)	h + 2,0 mm						

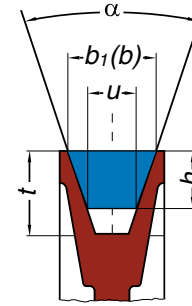

For BEHAbelt V-belts according to DIN 2215 / ISO 4184 pulleys for V-belts according to DIN 2217/ISO 4183 have to be used.

INSTALLATION, PULLEY DIAMETER, CENTER DISTANCE RELATED TO SHORE HARDNESS

Minimum pulley diameter range	
Shore 72A / 80A / 85A	10...30 mm
Shore 95A	35...80 mm

General belt hardness choice based on center to center design	
Shore 72A / 80A / 85A	max. 3m
Shore 95A	3...10 m

- On conveyors with fixed center distance between the pulleys, belts with lower shore hardness can be installed manually.
- Harder materials require tension device to install the belts
- Attention: The actual pre-tension may require a verification of the maximal possible load on the belt and the admissible bearing load to avoid overstress on pulleys and bearings.

Please contact us for the optimal belt design.

DRIVE PULLEY DESIGN CONVEYOR BELT: CALCULATION

Length of cylindrical area b_c

$$b_c = b_0 / 2$$

Pulley width b

$$b = b_0 \times 1,1$$

Crown bow h

$$h = (d + 100) / 450 \text{ mm}$$

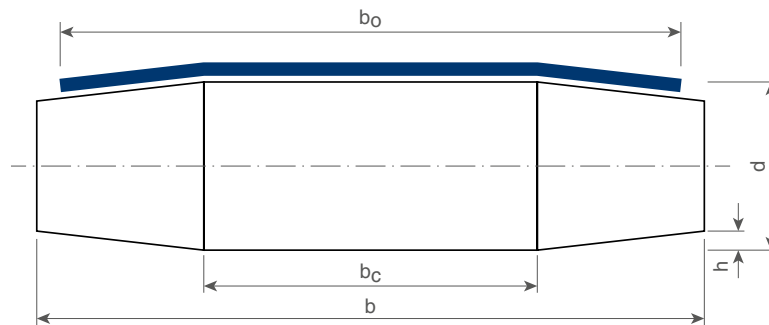

As a rule, machine designers traditionally use a drum design with the pitch 1/3 / 1/3 / 1/3. However, the 1/4 / 1/2 / 1/4 pitch has proven to be particularly suitable for soft belt types.

CALCULATION HELP FOR BELTS

Pretension force belt (N) =

$$k1\% \times \text{belt width (mm)} \times \text{pretension (\%)} \times 2$$

Axe load (N) =

$$k1\% \times \text{belt width (mm)} \times \text{pretension (\%)} \times 2 / \text{number of axes}$$

Theoretical max. conveyor load (kg) =

$$k1\% \times \text{belt width (mm)} \times \text{pretension (\%)} \times 0,1 / \text{coefficient of friction } \mu_{\text{dyn}} \text{ bottom surface belt to contact surface}$$

The mentioned coefficient of friction is the dynamic coefficient of friction. Due to the higher coefficient of friction μ_{stat} when starting the belt, we recommend to consider 2x the dynamic coefficient of friction as a reference value. This is particularly relevant if the conveyor belt is subjected to many start/stop operations. (☞ for μ_{dyn} see also table above)

Service

BEABELT HAS THE FIELD EXPERIENCE IN THE LOGISTIC INDUSTRY SINCE MORE THAN 45 YEARS

We have deep insight into the applications through our customers and our suppliers.
We are always developing innovative products and solutions for our customers based on our experience and know-how.



DETAILED ADVICE

It is important to us to support you with our experience in selecting the most suitable belt profile or belt for your application.

The know-how gained from many applications shows us that there is potential for optimisation in most processes.



CALCULATION AND DESIGN SUPPORT

BEHAbelt offers through its competent technical team with profound practical knowledge. We would be pleased to support you with calculations to optimise your application with the corresponding design of the belt profiles and belts and thus avoid downtimes.



FABRICATION

Our customers not only require belts by roll but also endless joined belts. This is why BEHAbelt offers "Express Confectioning Service".

When we designed the machines of our tailoring shop our goal was to being able to fabricate both, small and big quantities, at attractive cost and to ensure delivery of orders within a couple of days only - therefore we optimized machine set-up times and lead times.

An automated welding process ensures consistent quality for all possible belt geometries and coated belts.

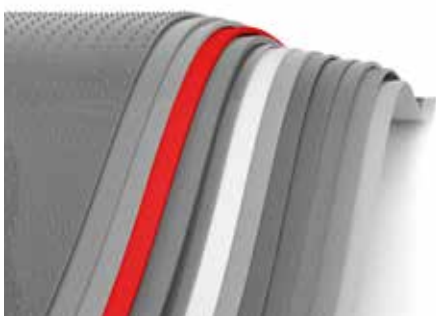

CUSTOMER-SPECIFIC BELTS

BEHAbelt offers you the exclusive and fast delivery of your desired profile or conveyor belt! If a standard profile does not meet the requirements of your application, BEHAbelt offers you the unique opportunity to develop a customer-specific product.

Thanks to our modern in-house tool shop, we are able to produce special profiles for you in the shortest possible time.

GET YOUR SAMPLES

We are happy to provide you with samples of your required products free of charge. We are looking forward to your message.

Phone: +49 7684 907-0



Your specialist dealer / system supplier

PBEPM0000097 · 02/20

BEHAbelt 
Made in Germany

BEHA Innovation GmbH

In den Engematten 16 · 79286 Glottertal/Germany

Tel.: +49 7684 907-0 · Fax: +49 7684 907-101

E-Mail: info@behabelt.com · Internet: www.behabelt.com