

**Vacuum Gripping Systems**  
Area and Layer Gripping Systems  
Suction Spiders



# Schmalz

## World of Vacuum Technology

Consistent customer orientation and groundbreaking innovations, excellent quality and comprehensive consulting competence make Schmalz the world's leading partner for vacuum technology in automation, handling and clamping applications.

As a company that acts globally and offers innovative products and services, we provide our customers with efficient solutions tailored precisely to their particular applications' requirements. We inspire our customers everywhere where production processes are designed more efficiently through the use of vacuum technology.

With our certifications, including ISO 9001 for quality management, ISO 14001 for environmental management and ISO 50001 for energy management, we guarantee our partners standardized and sustainable processes.

## Schmalz Media Center

 [www.schmalz.com/video](http://www.schmalz.com/video)

See our vacuum gripping systems in action. The Schmalz Media Center will take you with few clicks to the application examples in your industry segment – user-friendly, informative and practical.



### Lights, Camera, Action!

Just scan the QR code with your smartphone, select an industry segment and play the video.



# Vacuum Gripping Systems from Schmalz

## Schmalz – Your Partner for System Solutions

4

### Industry Solutions

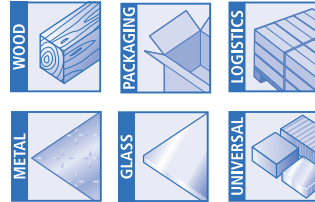

### Vacuum Gripping Systems in Use

6

### Area Gripping Systems



### Vacuum Area Gripping Systems FXP / FMP Flexibility and Power

12

**New!**



### Vacuum Area Gripping Systems SBX Very Robust Grippers for the Timber and Woodworking Industry

28



### Layer Gripping Systems



### Vacuum Layer Gripping Systems SPZ High-Performance Palletizers for Warehousing and Intralogistics

32

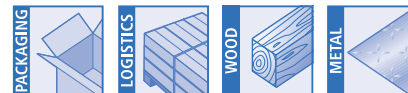

### Suction Spiders



### Vacuum Suction Spiders SSP Custom Made Solutions for End-of-Arm-Tooling

36



### Contact

39



**“Our system consultants and designers have extensive knowledge in the field of vacuum technology, combined with decades of experience in the international mechanical and plant engineering. Entrust your automation task to us: we understand your requirements.”**

Peter Gröning  
Head of Business Development and System House  
Vacuum Gripping Systems

## Schmalz – Your Partner for System Solutions

Schmalz is a competent and experienced partner for vacuum system solutions for automation. With first-class products, extensive experience and custom made services, a Schmalz system helps you to minimize costs throughout the entire life cycle – whether you utilize Schmalz for the efficient procurement of individual components or you seek full project management for the creation of turn-key solutions.

### Services with Added Value Throughout the Entire Life Cycle



#### Consultation and System Design

- Qualified consultation with assistance from an experienced project manager
- Consideration of application-specific requirements and customer processes
- Resource efficient system design

#### Engineering

- No design time required on your side
- Future-proof solution in accordance with the latest technological standards
- Vacuum technology efficiently combined with mechatronic solutions

#### System Construction and Tests

- Professional and service-friendly construction of the gripping system
- Use of high-quality and standardized components
- Safety and functionality verified through tests with the original workpieces

#### Procurement and Logistics

- Fast delivery through single sourcing
- Elimination of time required for procurement of individual components and associated logistics

#### Mounting and Installation

- Professional mounting at the operation site and support during process integration on request

#### Start of Operations and Training

- Hand-over of a fully functional system
- Professional on-site training for your employees
- Comprehensive documentation

#### Operation and Service

- Optional solutions for process monitoring ensure smooth operation and high availability
- Fast service for replacement parts

# Exceptional in Automation

## From the Components to Your Custom Gripping System



Vacuum components from Schmalz

### Innovative Vacuum Components

A gripping system is only as good as its individual parts. Benefit from the widest range of vacuum components on the market:

- Optimally coordinated individual components from a single supplier, from suction pads, to vacuum generators, to system monitoring units
- Numerous products specially developed for specific industries
- Integrated state-of-the-art technology for energy and process control
- Modularity ensured through standardized interfaces and connection systems



In a dialog with our customers

### Knowledge Through Experience

You can rely on our expertise, obtained from over 30 years of experience in the area of vacuum technology:

- Our system consultants engage in a dialog with you on site to help develop the solution
- Specialist industry managers know and understand the processes and requirements specific to your industry
- Our approximately 400 registered and granted industrial property rights demonstrate our talent for innovation and our capability for developing solutions
- Transfer of knowledge in customer seminars at the Schmalz Academy

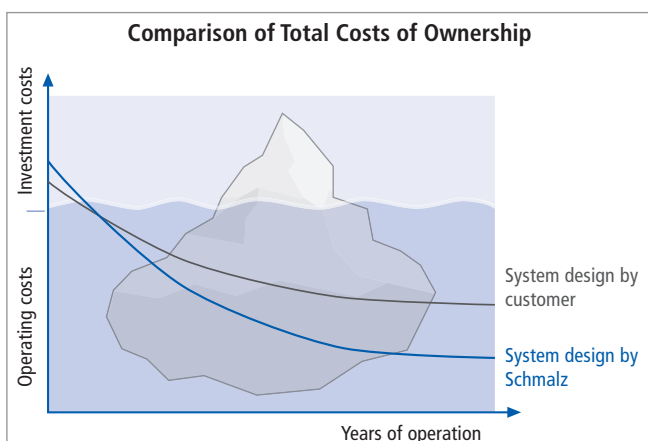

Comparison of the total costs of ownership of a Schmalz system solution with those for a system designed by the customer: Our system experience helps you to optimize productivity and operating costs (e.g. for energy consumption, maintenance and spare parts) throughout the entire duration of operation.

### System Solutions from Schmalz Minimize Total Costs of Ownership

Reduction of the total costs of ownership through optimally coordinated systems:

- Custom-tailored implementation of your requirements
- Schmalz assumes responsibility for the system
- Concurrent engineering generates mutual transfer of knowledge
- Outsourcing of vacuum expertise combined with mechatronic system expertise
- Schmalz acts as an extended workbench
- Conservation of your resources and the ability to focus on your core competencies
- Active support during start of operations and on-site service



## Industry Solutions

### Vacuum Gripping Systems in Use

Vacuum gripping systems from Schmalz are used in a wide variety of industries to ensure efficient process automation. Our many years of experience and our close relationship with our customers mean we know your processes. That allows us to produce products to meet the highest industry requirements. Our range of solutions stretches from flexible, easy integrate universal grippers to complex, custom-designed system solutions.

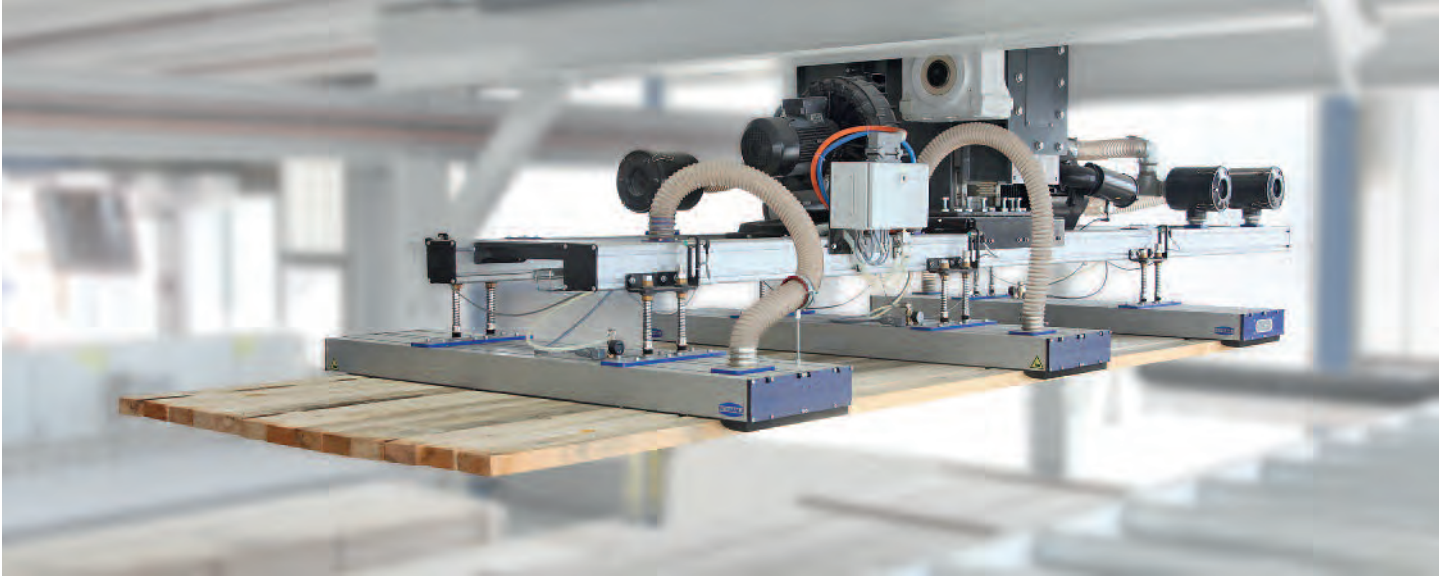

Vacuum suction spider SSP being used for handling wooden boards



## Wood

### Powerful and Secure Handling Under Demanding Operating Conditions

Whether for gentle handling of furniture parts or powerful gripping of unplanned boards and planks, vacuum gripping systems from Schmalz can be used to automate handling processes in woodworking and furniture production.

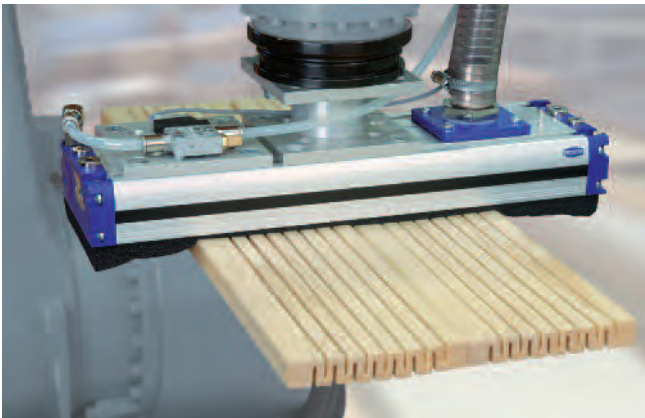

Vacuum area gripping system FMP being used to handle structured wooden boards

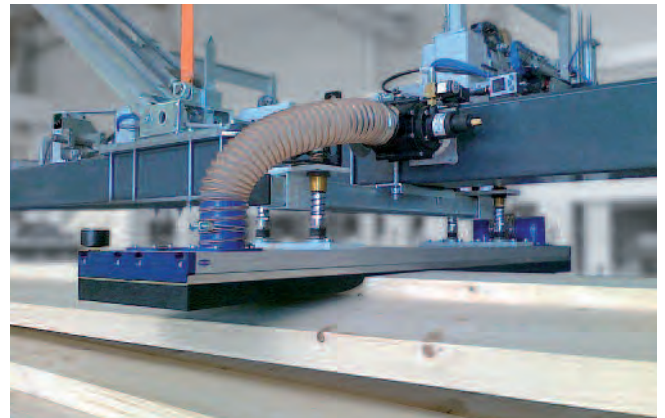

Vacuum area gripping system FMP in a double gripper configuration being used to handle construction timber



Vacuum area gripping system SBX for handling layers of wooden boards

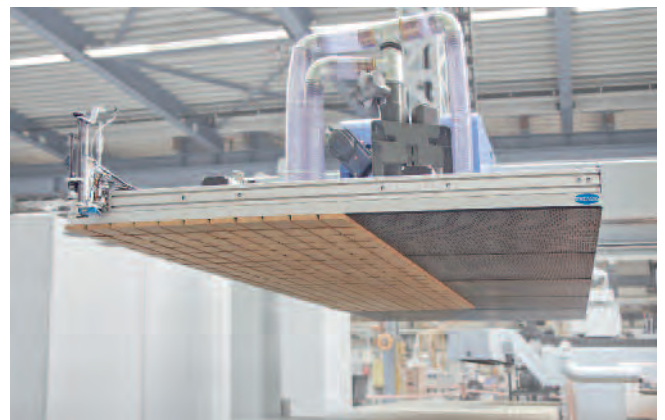

Schmalz Nesting Gripper SPZ-NG for destacking complete layers of workpieces during nested manufacturing



Vacuum area gripping system FMP being used to load shipping boxes with smaller boxes



## Packaging

### Flexible Solutions for Case Packing and End-of-Line Palletizing

Packaging processes demand flexibility, fast acceleration and short cycle time. A custom-designed vacuum gripping system from Schmalz allows you to dynamically palletize and de-palletize a wide range of packaging, including bending boxes, shrink-wrapped packages, bags and cans.



Vacuum area gripping system FXP being used to handle foil-wrapped goods

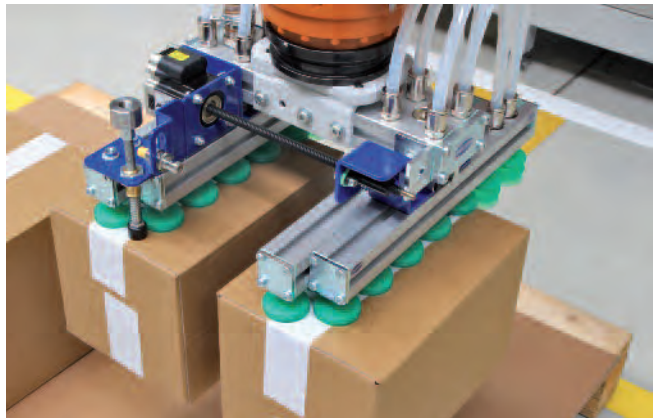

Vacuum suction spider SSP with electrically adjustable grippers for separating boxes or building layers



Vacuum layer gripping system SPZ for handling empty jars



Vacuum area gripping system FXP being used to handle beverage cans





Vacuum layer gripping system SPZ-M-C for palletizing and de-palletizing a wide range of goods



## Logistics

### Efficient Palletizing, Layer by Layer

Distribution logistics involve transporting countless goods around the globe every day. Schmalz palletizers are employed at transfer points to palletize and depalletize them in complete layers. Even workpieces which can hardly be gripped by vacuum are manageable thanks to innovative gripping technology.

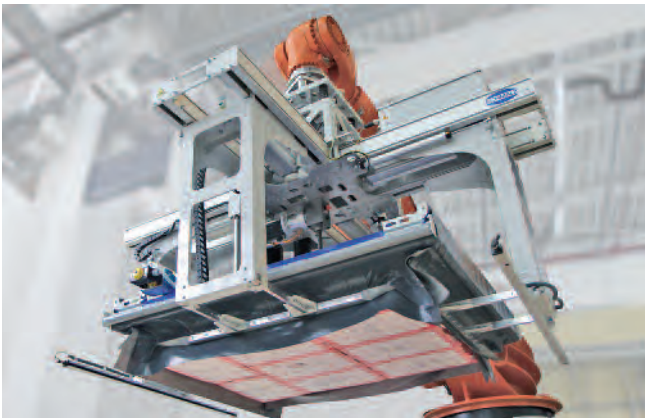

Vacuum layer gripping system SPZ-M-C being used to palletize beverage trays



Vacuum suction spider SSP being used to pick boxes in a goods distribution center



Vacuum layer gripping system SPZ for handling cardboard boxes in layers



Vacuum layer gripping system SPZ on a forklift for picking cans



Vacuum area gripping system FXP being used to handle plastic bumpers



## Automotive and Sheet Metal

### Intelligent Vacuum for Automation with Added Value for Processes

Body shop, shell construction, vehicle assembly – aside from sheet metal handling Schmalz gripping systems are used in automobile manufacturing to handle many other materials such as plastics, glass and carbon fiber. Intelligent systems allow you to optimize cycle times, energy consumption and availability.



Vacuum area gripping system FXP being used to handle car body parts in the body shop



Vacuum area gripping system FXP being used to handle automotive glass during vehicle assembly



Vacuum area gripping system FMP being used to handle sections in layers

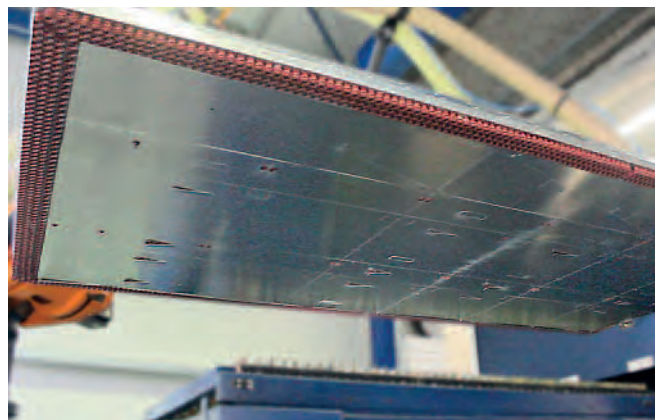

Vacuum layer gripping system SPZ for destacking blanks during laser fabrication



**Solar** | Vacuum suction spider SSP being used to handle module glass



## Other Industry Solutions

### From Universal to Custom – Gripper Solutions for Virtually any Application

Vacuum gripping systems from Schmalz are used in many other industries to ensure flexible and economical automation processes: from versatile universal grippers to custom specific solutions designed for the customer.

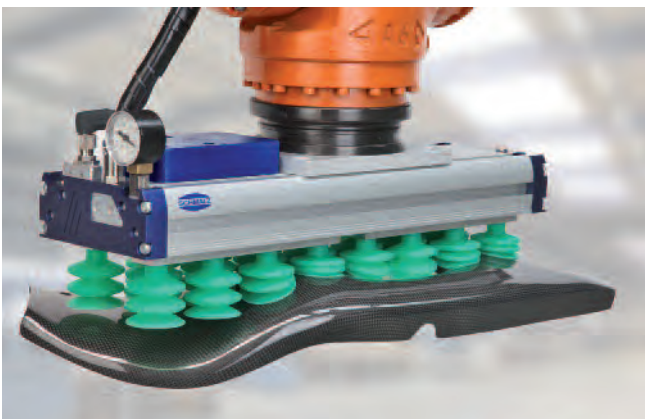

**Composites** | Vacuum area gripping system FXP being used to handle molded CFRP parts

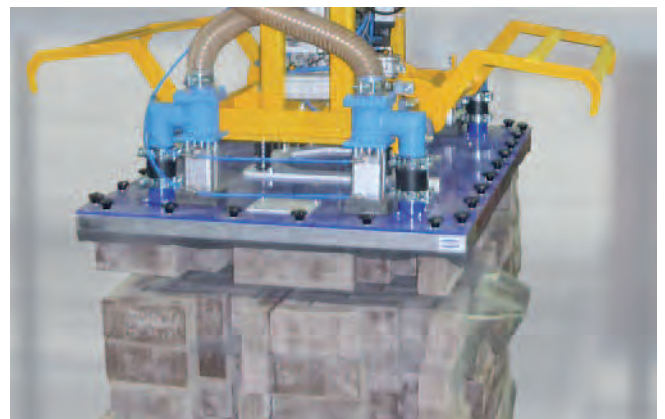

**Construction materials** | Vacuum layer gripping system SPZ with gripping arms for handling bricks and pallets



**Construction materials** | Vacuum layer gripping system SPZ being used to handle clinker bricks

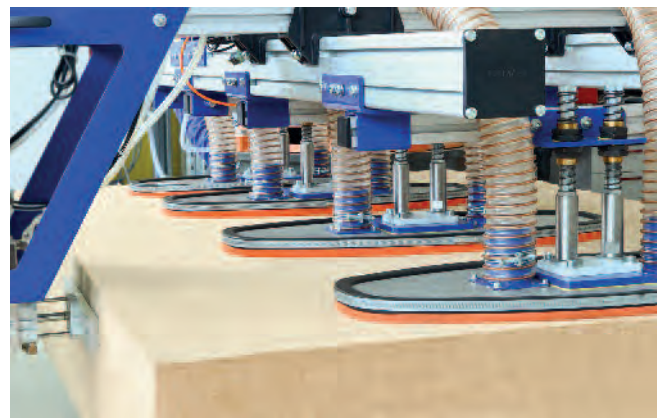

**Construction materials** | Vacuum suction spider SSP being used to handle and separate porous sheets of insulation



**New!**

## Vacuum Area Gripping Systems Universal Grippers with Extra Power

Everything firmly in its grip – The area grippers from Schmalz' FXP / FMP series are truly versatile products that are setting new standards in process reliability, energy efficiency and availability in the area of automated vacuum handling.

Schmalz has developed the vacuum area gripping system SBX for particularly rugged applications in the timber and wood-working industry (from p. 28).

# Vacuum Area Gripping Systems FXP / FMP

## Flexibility and Power

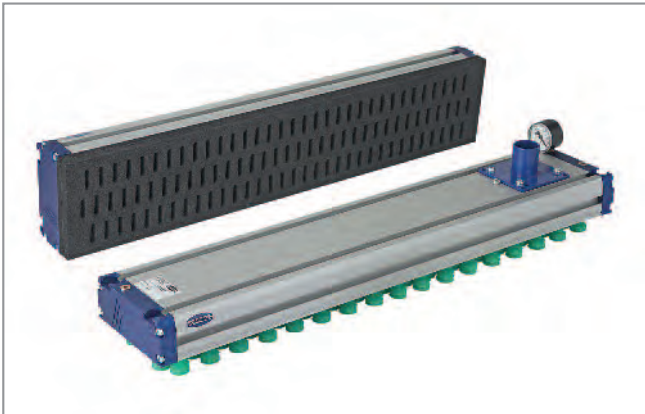

Vacuum area gripping systems FXP / FMP

### Application

- Universal gripper for handling workpieces regardless of size, geometry, material and surface
- Handling of workpieces made from various materials, such as wood (coated or unplanned), packaging (boxes, bags or cans), metal sheets, glass, plastics, CFRP, etc.
- Handling of porous workpieces and workpieces with gaps
- Handling of workpieces with an undefined pick-up position
- Ideal for use on robots due to its low weight

### Highlights



#### 86 % More Power

A benchmark test indicates that the FXP / FMP series from Schmalz generates an 86 % higher suction force on average than comparable grippers on the market. This is due to innovative features such as vacuum boosters, leak-free check valves and sealing foam with high suction cell density.

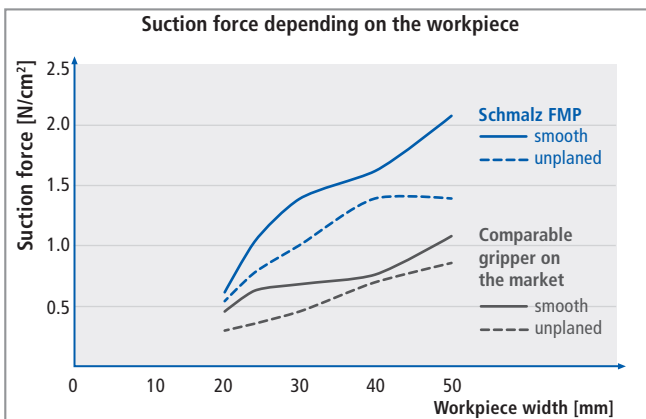

Comparison of suction forces for the example of FMP



Powerful handling of heavy wooden beams



#### Unique Flexibility

Handling of workpieces wider than 20 mm, regardless of material, geometry, surface and position



#### High Energy Efficiency

Optimization of the flow ensures that energy is used more efficiently, which permanently reduces operating costs



#### Low Weight

Maximum acceleration within the process and reducing system costs by use of smaller robots



#### Low Sound Level

Low-noise operation with a sound level of only 74 dB(A)



#### Minimal Maintenance

Easy retooling of flow technology and fast replacement of sealing elements

# Vacuum Area Gripping Systems FXP / FMP

Modular Design with Individually Adapted Vacuum Generation



## FXP: Integrated Vacuum Generation

As a unit that is ready for connection, the area gripping system FXP is equipped with a plug-in ejector for vacuum generation. It can be individually configured and quickly retooled in case of changing application conditions. The modular design ensures easy maintenance and enables the integration of additional functions for energy and process optimization directly in the gripper.

### Aluminum base section

- High stiffness and low weight
- Lateral T-slots for fixation of sensors
- Integrated air duct for separation
- Variable gripper length possible

### Vacuum booster

- Faster evacuation due to reduced inner volume
- Maximum power is reached instantly

### Valve film

- For quickly changing the valve type and size
- Self-cleaning effect

### End cover with integrated functions

- Compressed air connection, vacuum gauge as well as optional vacuum switch and control valve

### Silencer

### Vacuum generation

- Plug-in ejector

### Sealing elements

- Fig. shows suction pads with push-in function
- Also available with sealing foam with optimized adhesive film

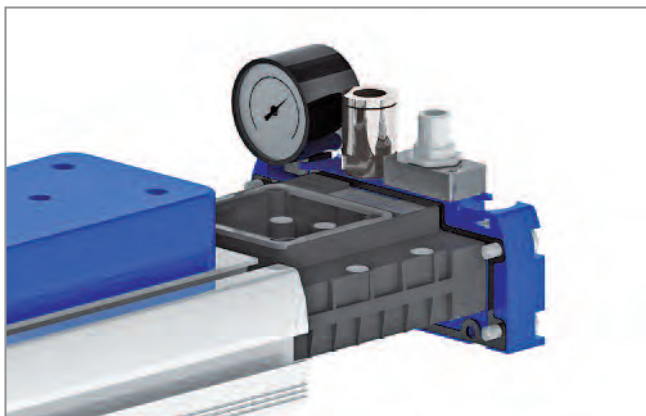
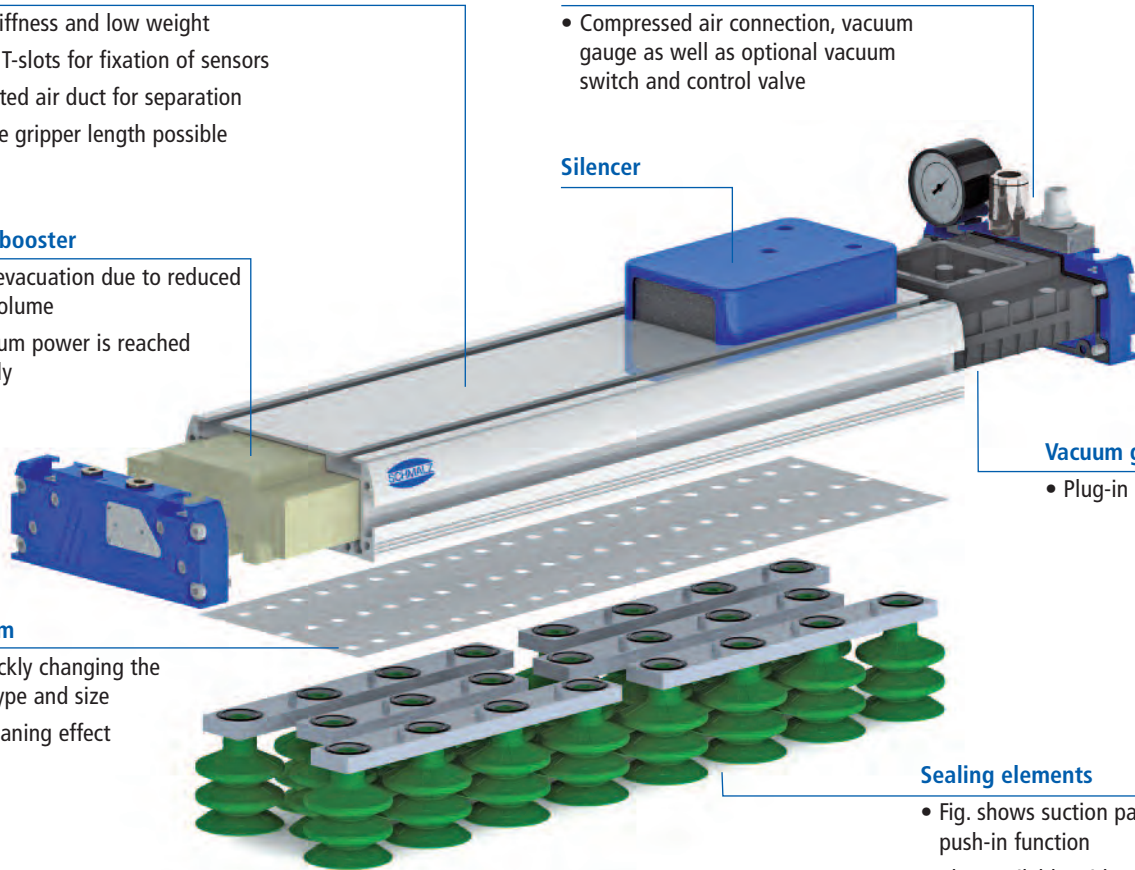

## Integrated Plug-in Ejector

- Optimized ejector performance: with comparatively low maximum vacuum, the ejector generates a high volume flow and thus provides high holding forces, especially for applications with porous workpieces
- Fast evacuation and high suction flow even at low vacuum values
- Control valves integrated into the end cover for controlling the suction and blow off functions (optional)
- Silencer for reducing the sound level to 74 dB(A)
- Ready to connect unit, easy to clean

# Vacuum Area Gripping Systems FXP / FMP

Modular Design with Individually Adapted Vacuum Generation

## FMP: External Vacuum Generation

The area gripping system FMP has the same modular design as the type FXP, but is equipped with a connection piece for external vacuum generators. It is therefore suitable for use in combination with powerful pumps and blowers.

Connection piece for external vacuum generators

Aluminum base section with vacuum booster

End cover

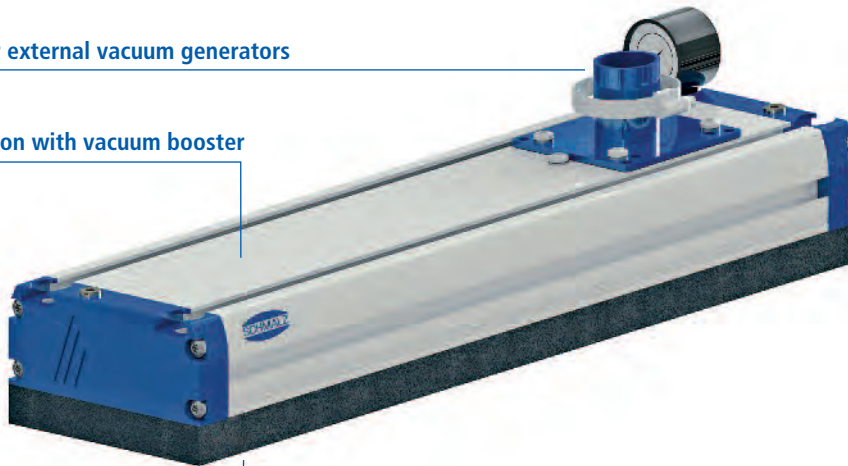

Valve film and sealing element

- Fig. shows sealing foam

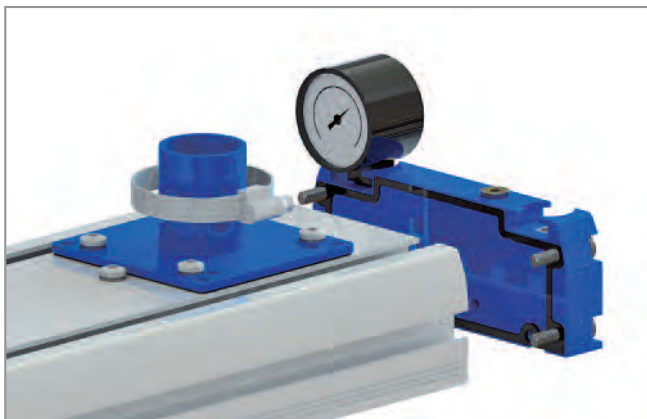

## Connection Piece for External Vacuum Generation

- Allows use of an electrical vacuum generator (blower or pump)
- Suitable for handling very porous or warped workpieces due to high flow rate

## Selection Aid

Application features	FXP	FMP
Minimization of interfering edges caused by hoses and attached vacuum generator (integration of functions)	✓	
Easy mounting and quick connection of the gripper	✓	
Minimal system costs (investment costs including vacuum generation, hoses and controller)	✓	
Minimal operating costs (because of the option of electrical vacuum generation), especially for applications with multiple grippers		✓
Handling of highly porous workpieces		✓

# Vacuum Area Gripping Systems FXP / FMP

## Innovative Valve Technology



Valve type and size can be changed easily and quickly in case of changing requirements

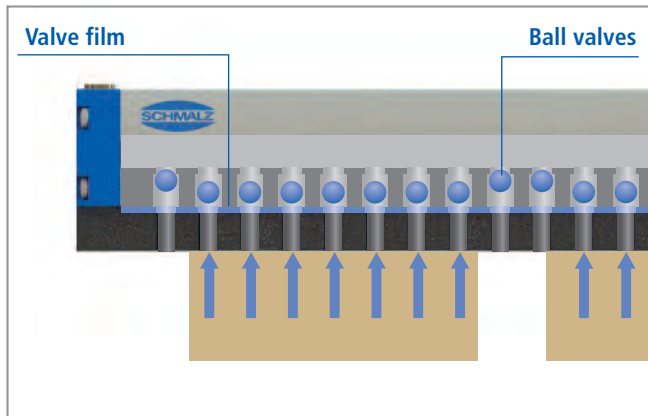

### Check Valves SVK

- Ball valves integrated in the base section for closing off uncovered suction cells
- Leak-free integrated, resulting in a higher vacuum as well as improved energy efficiency and holding force
- Valve film with clover shape for high flow rate and quick picking up and blowing off
- Proper functioning ensured even with unplaned surfaces

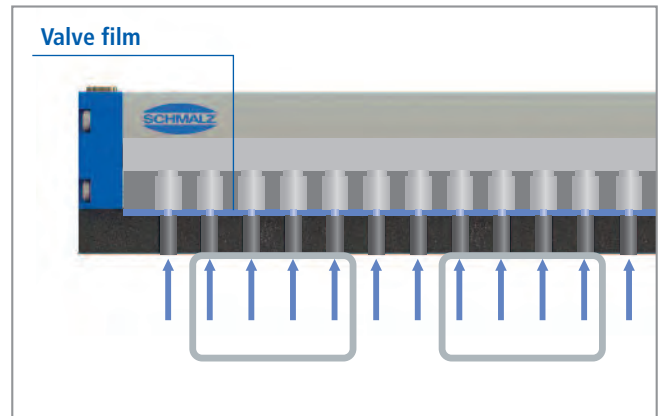

### Flow Restrictors SW

- Valve film with integrated flow restrictors to minimize leakage losses due to uncovered suction cells
- Suitable for swiveling operations and high accelerations
- Different flow diameters available (optional)

## Selection Aid

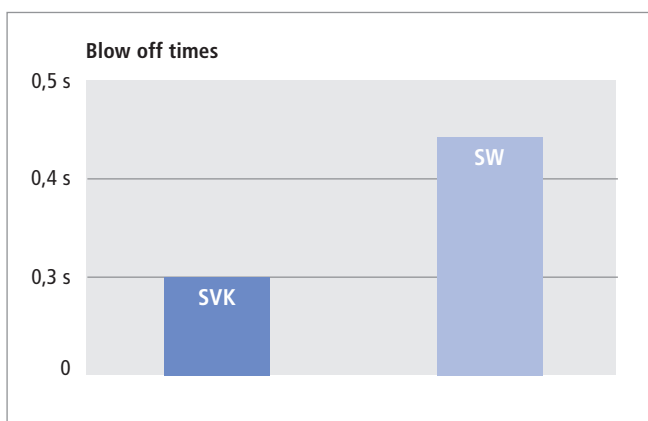

The higher nominal flow of the SVK valve type allows it to achieve significantly shorter blow off times than the SW type can (values in fig. measured at a gripper length of 442 mm)

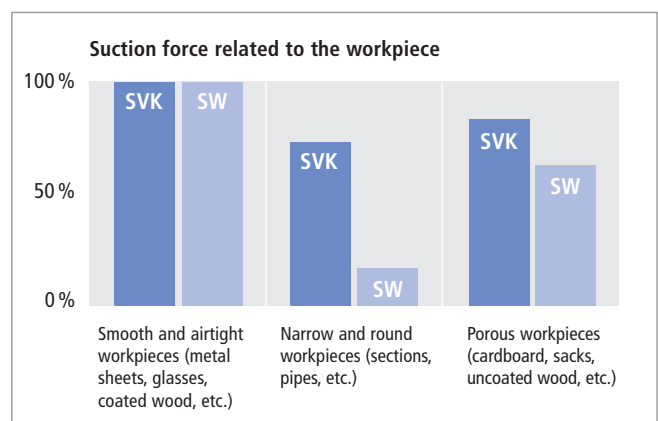

The valve type SVK achieves a higher suction force than the SW in case of porous workpieces and low degree of gripper coverage

Application features	SVK	SW
Smooth and airtight workpieces (e.g. metal sheets, glass, coated wood)	✓	✓
Porous workpieces (e.g. boxes, sacks, uncoated wood)	✓	
Structured surfaces	✓	
Workpieces with low of gripper coverage (e.g. pipes, sections)	✓	
Minimum cycle times (active blow off)	✓	
Optimization of energy efficiency	✓	
Swiveling movements > 45°		✓



# Vacuum Area Gripping Systems FXP / FMP

Flexible, Quick-Change Sealing Elements



Sealing foam and suction pads can be changed quickly and easily due to the optimized adhesive film and the push-in function



## Sealing Foam with Quick-Change Adhesive Film

- Optimal adjustment capabilities
- Quick rebound for short cycle times
- Replaceable without adhesive residue and without the need to clean the sheet
- Intended for workpieces wider than 20 mm (in the design with 5 suction rows, on request)
- With optional filter mat

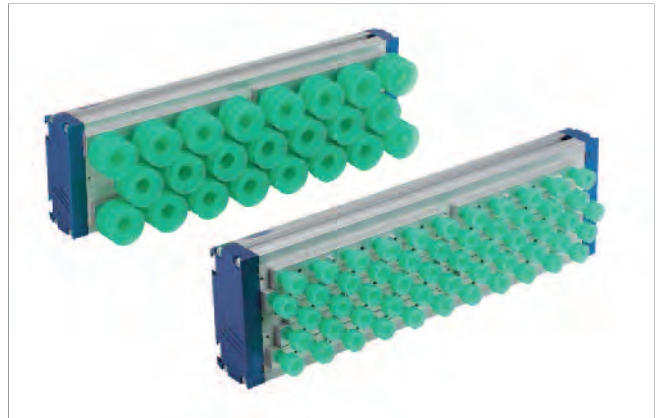

## Suction Pads with Push-in Function

- Optimal height compensation and damping effect
- Quick replacement due to the push-in mechanism
- Diameters 20 mm and 40 mm
- Made from FDA-compliant silicone
- With optional insert filter

## Selection Aid

Application features	Sealing foam	Suction pads
Rigid workpieces such as sheets, metal sheets, boards, sections and pallets	✓	
Flexible workpieces such as cardboard boxes, sacks, bags and trays		✓
Elongated workpieces such as strips, sections, boards	✓	
Workpieces with rough and structured surface	✓	
Handling of smaller product layers such as jars (open or closed) and cans with a continuous edge	✓	

## Additional Functions, Compactly Integrated

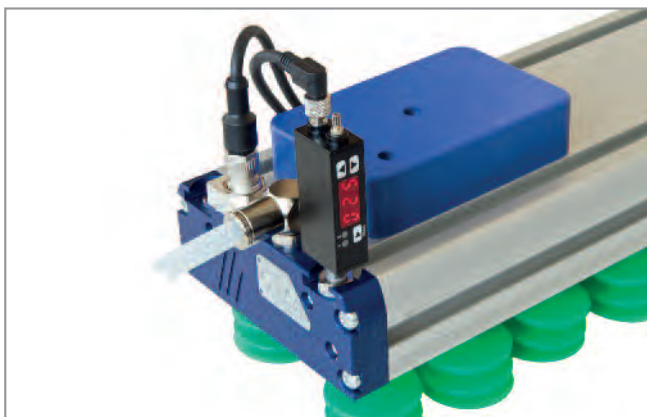

## End Cover with Integrated Functions

Minimization of system costs and installation times through integration of:

- Compressed air connection for ejector supply (type FXP)
- Control valves for switching the suction and blow off functions on/off (optional for type FXP-S)
- Connection for the blow off and separation functions
- Option to attach a vacuum gauge or vacuum switch

# Vacuum Area Gripping Systems FXP / FMP

## Product Specifications





### Note on Configuration



Tests with the original workpieces are necessary to ensure that the area gripping system functions properly. We will gladly conduct these for you in our test center in order to find the best solution for your application.

### Designation Code

Designation code explained using the example of: FXP-S-SVK 442 5R36 SPB2-20P

FXP	S*	SVK	442	5R	36	SPB2-20P
Type	Version	Valve technology	Length [mm]	Number of suction rows	Suction cell grid distance [mm]	Sealing element [mm]
FXP (Integrated vacuum generation)	S Control valves	SVK Check valves	442	5R 5 suction rows	36	SPB2-20P
FXP (Integrated vacuum generation)	S Control valves	SVK Check valves	442 640 838	3R 3 suction rows (standard)	18	 Sealing foam (Height = 20)
FMP (External vacuum generation)		SW Flow restrictors	1,234 1,432	5R 5 suction rows (on request)	18	 Sealing foam (Height = 20)
				5R 5 suction rows	36	 SPB2-20P Suction pad (Ø 20)
				3R 3 suction rows	54	 SPB2-40P Suction pad (Ø 40)

### \*Integrated Control Valves (Optional)

- Control of vacuum on/off (24V DC, normally open) and blow off on/off (24V DC, normally closed)
- Integrated in the end cover of the type FXP
- Electrical connection: M12 plug (4-pole)
- Part number on request

### Service and Practical Tips

- Lift capacity and handling safety can be increased for uneven workpieces and rough surfaces by pressing down on them firmly (foam and suction pads should ideally be compressed by 50 %) and by using jointed and spring-loaded level compensation for the area gripping system
- The service life of the sealing foam is 3 to 12 months (depending on the application, when setting down and lifting linearly)
- The service life of the suction pad is 6 to 12 months (depending on the application, when setting down and lifting linearly)
- Six-month maintenance intervals of the area gripping system are recommended

# Vacuum Area Gripping Systems FXP / FMP

Design with Sealing Foam (Height = 20 mm)



## Ordering Data for Area Gripping Systems

Type*	Part number		Type*	Part number	
	Without filter	With filter		Without filter	With filter
FXP-SVK 442 3R18	10.01.38.00675	10.01.38.00680	FMP-SVK 442 3R18	10.01.38.00303	10.01.38.00415
FXP-SVK 640 3R18	10.01.38.00676	10.01.38.00681	FMP-SVK 640 3R18	10.01.38.00411	10.01.38.00416
FXP-SVK 838 3R18	10.01.38.00677	10.01.38.00682	FMP-SVK 838 3R18	10.01.38.00412	10.01.38.00417
FXP-SVK 1234 3R18	10.01.38.00678	10.01.38.00683	FMP-SVK 1234 3R18	10.01.38.00413	10.01.38.00418
FXP-SVK 1432 3R18	10.01.38.00679	10.01.38.00684	FMP-SVK 1432 3R18	10.01.38.00414	10.01.38.00419
FXP-SW 442 3R18	10.01.38.00685	10.01.38.00690	FMP-SW 442 3R18	10.01.38.00433	10.01.38.00428
FXP-SW 640 3R18	10.01.38.00686	10.01.38.00691	FMP-SW 640 3R18	10.01.38.00434	10.01.38.00429
FXP-SW 838 3R18	10.01.38.00687	10.01.38.00692	FMP-SW 838 3R18	10.01.38.00435	10.01.38.00430
FXP-SW 1234 3R18	10.01.38.00688	10.01.38.00693	FMP-SW 1234 3R18	10.01.38.00436	10.01.38.00431
FXP-SW 1432 3R18	10.01.38.00689	10.01.38.00694	FMP-SW 1432 3R18	10.01.38.00437	10.01.38.00432

\*Customer-specific gripper dimensions on request

## Ordering Data for Sealing Foam (Spare Part)

Type	Part number		
		Without filter	With filter
DI-PL 442x128 3R18		10.01.38.00113	10.01.38.00192
DI-PL 640x128 3R18		10.01.38.00405	10.01.38.00408
DI-PL 838x128 3R18		10.01.38.00140	10.01.38.00409
DI-PL 1234x128 3R18		10.01.38.00193	10.01.38.00196
DI-PL 1432x128 3R18		10.01.38.00406	10.01.38.00410

Note: A special foam for vacuum applications is used. Other foam heights and types (e.g. oil-resistant and temperature-resistant foams) on request

## Technical Data

Type	Number of suction cells	Air consumption* [l/min]	Max. suction flow [l/min]	Max. degree of evacuation [%]	Suction force** [N]	Weight [kg]
FXP-SVK 442 3R18	66	250	1,050	55	550	2.6
FXP-SVK 640 3R18	99	375	1,350	55	820	3.4
FXP-SVK 838 3R18	132	500	1,600	55	1,090	4.2
FXP-SVK 1234 3R18	198	875	2,940	55	1,650	5.7
FXP-SVK 1432 3R18	231	1,000	3,180	55	1,910	6.3
FXP-SW 442 3R18	66	250	1,050	55	440	2.5
FXP-SW 640 3R18	99	375	1,350	55	660	3.3
FXP-SW 838 3R18	132	500	1,600	55	870	4.1
FXP-SW 1234 3R18	198	875	2,940	55	1,310	5.6
FXP-SW 1432 3R18	231	1,000	3,180	55	1,530	6.2

Sound level: 74 dB(A)

Type	Number of suction cells	Required suction flow*** [l/min]	Suction force** [N]	Weight [kg]
FMP-SVK 442 3R18	66	300	550	2.5
FMP-SVK 640 3R18	99	450	820	3.3
FMP-SVK 838 3R18	132	600	1,090	4.1
FMP-SVK 1234 3R18	198	900	1,650	5.5
FMP-SVK 1432 3R18	231	1,050	1,910	6.1
FMP-SW 442 3R18	66	300	440	2.4
FMP-SW 640 3R18	99	450	660	3.2
FMP-SW 838 3R18	132	600	870	4.0
FMP-SW 1234 3R18	198	900	1,310	5.4
FMP-SW 1432 3R18	231	1,050	1,530	6.0

\*For compressed air with 5.5 bar input pressure

\*\*At -0.25 bar and with the gripper fully covered by a workpiece typical for the application (wooden board with structured surface)

\*\*\*The external vacuum generator used must supply at least the specified suction flow (at the vacuum connection piece of the FMP) at -0.25 bar but max. 135 % of the specified suction flow

# Vacuum Area Gripping Systems FXP / FMP

Design with Sealing Foam (Height = 20 mm)



## Design Data FXP

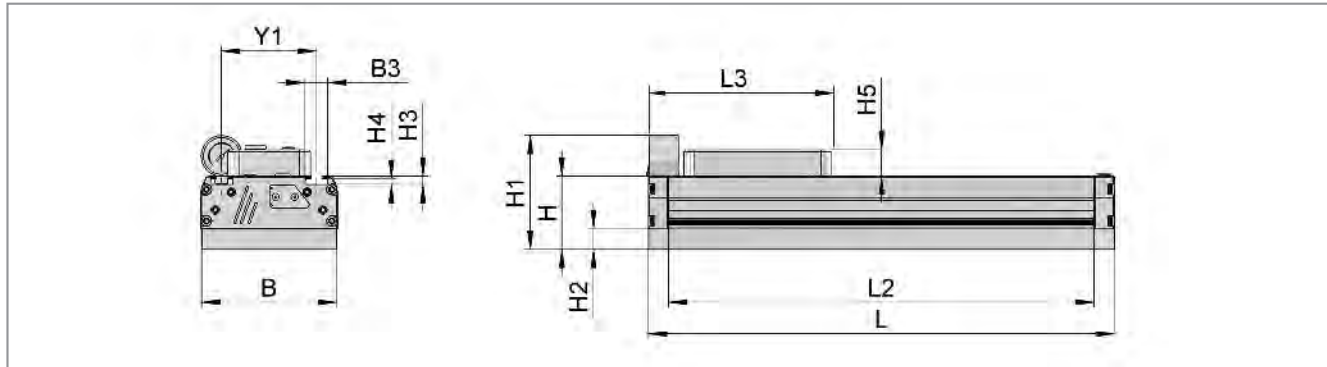

Type	Dimensions [mm]											
	B	B3	H	H1	H2	H3	H4	H5	L	L2	L3	Y1
FXP-SVK 442 3R18	130	21.6	70	111	20	7.7	5.5	28	442	404	154	90
FXP-SVK 640 3R18	130	21.6	70	111	20	7.7	5.5	28	640	602	154	90
FXP-SVK 838 3R18	130	21.6	70	116	20	7.7	5.5	28	838	800	154	90
FXP-SVK 1234 3R18	130	21.6	70	116	20	7.7	5.5	28	1,234	1,196	154	90
FXP-SVK 1432 3R18	130	21.6	70	116	20	7.7	5.5	28	1,432	1,394	154	90
FXP-SW 442 3R18	130	21.6	70	111	20	7.7	5.5	28	442	404	154	90
FXP-SW 640 3R18	130	21.6	70	111	20	7.7	5.5	28	640	602	154	90
FXP-SW 838 3R18	130	21.6	70	116	20	7.7	5.5	28	838	800	154	90
FXP-SW 1234 3R18	130	21.6	70	116	20	7.7	5.5	28	1,234	1,196	154	90
FXP-SW 1432 3R18	130	21.6	70	116	20	7.7	5.5	28	1,432	1,394	154	90

Note: Two ejectors/silencer box covers are used for the 1,234 mm and 1,432 mm lengths. Type FXP requires compressed air hose 12/9 mm

## Design Data FMP

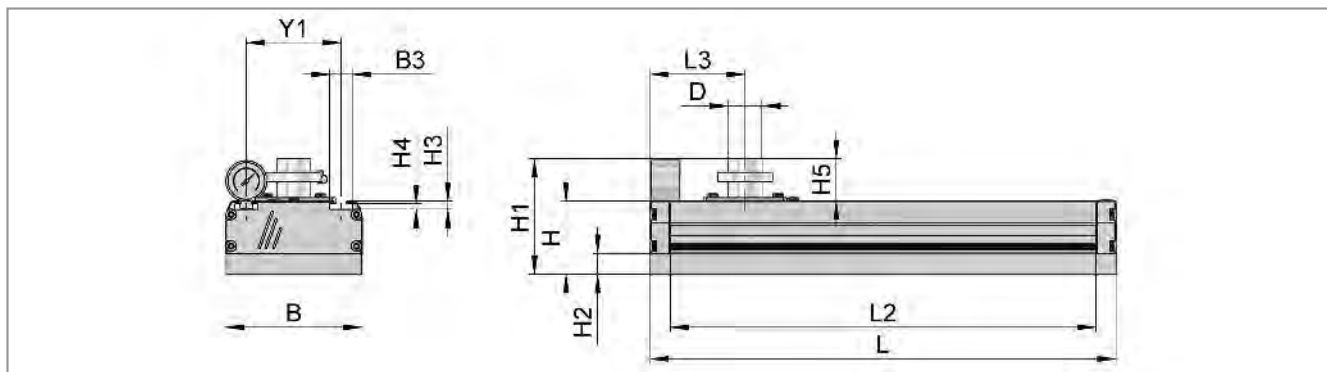

Type	Dimensions [mm]												
	B	B3	D	H	H1	H2	H3	H4	H5	L	L2	L3	Y1
FMP-SVK 442 3R18	130	21.6	32	70	111	20	7.7	5.5	41	442	404	90	90
FMP-SVK 640 3R18	130	21.6	32	70	111	20	7.7	5.5	41	640	602	90	90
FMP-SVK 838 3R18	130	21.6	60	70	116	20	7.7	5.5	46	838	800	90	90
FMP-SVK 1234 3R18	130	21.6	60	70	116	20	7.7	5.5	46	1,234	1,196	90	90
FMP-SVK 1432 3R18	130	21.6	60	70	116	20	7.7	5.5	46	1,432	1,394	90	90
FMP-SW 442 3R18	130	21.6	32	70	111	20	7.7	5.5	41	442	404	90	90
FMP-SW 640 3R18	130	21.6	32	70	111	20	7.7	5.5	41	640	602	90	90
FMP-SW 838 3R18	130	21.6	60	70	116	20	7.7	5.5	46	838	800	90	90
FMP-SW 1234 3R18	130	21.6	60	70	116	20	7.7	5.5	46	1,234	1,196	90	90
FMP-SW 1432 3R18	130	21.6	60	70	116	20	7.7	5.5	46	1,432	1,394	90	90

Note: Vacuum hose with internal diameter equal to dimension D required

# Vacuum Area Gripping Systems FXP / FMP

Design with Suction Pads ( $\varnothing = 20 \text{ mm}$ )

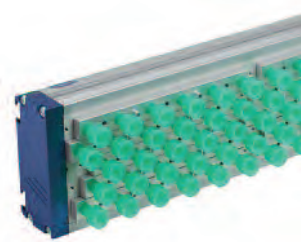

## Ordering Data for Area Gripping Systems

Type*	Part number		Type*	Part number	
	Without filter	With filter		Without filter	With filter
FXP-SVK 442 5R36 SPB2-20P	10.01.38.00735	10.01.38.00740	FMP-SVK 442 5R36 SPB2-20P	10.01.38.00323	10.01.38.00479
FXP-SVK 640 5R36 SPB2-20P	10.01.38.00736	10.01.38.00741	FMP-SVK 640 5R36 SPB2-20P	10.01.38.00475	10.01.38.00480
FXP-SVK 838 5R36 SPB2-20P	10.01.38.00737	10.01.38.00742	FMP-SVK 838 5R36 SPB2-20P	10.01.38.00476	10.01.38.00481
FXP-SVK 1234 5R36 SPB2-20P	10.01.38.00738	10.01.38.00743	FMP-SVK 1234 5R36 SPB2-20P	10.01.38.00477	10.01.38.00482
FXP-SVK 1432 5R36 SPB2-20P	10.01.38.00739	10.01.38.00744	FMP-SVK 1432 5R36 SPB2-20P	10.01.38.00478	10.01.38.00483
FXP-SW 442 5R36 SPB2-20P	10.01.38.00745	10.01.38.00750	FMP-SW 442 5R36 SPB2-20P	10.01.38.00484	10.01.38.00489
FXP-SW 640 5R36 SPB2-20P	10.01.38.00746	10.01.38.00751	FMP-SW 640 5R36 SPB2-20P	10.01.38.00485	10.01.38.00490
FXP-SW 838 5R36 SPB2-20P	10.01.38.00747	10.01.38.00752	FMP-SW 838 5R36 SPB2-20P	10.01.38.00486	10.01.38.00491
FXP-SW 1234 5R36 SPB2-20P	10.01.38.00748	10.01.38.00753	FMP-SW 1234 5R36 SPB2-20P	10.01.38.00487	10.01.38.00492
FXP-SW 1432 5R36 SPB2-20P	10.01.38.00749	10.01.38.00754	FMP-SW 1432 5R36 SPB2-20P	10.01.38.00488	10.01.38.00493

\*Customer-specific gripper dimensions on request

## Ordering Data for Suction Pads (Spare Parts)

Type	Part number		
		Without filter	With filter
SPB2 20 SI-40 P		10.01.06.03125	10.01.38.00465

Note: Other suction pad types (construction, material, diameter) available on request

## Technical Data

Type	Number of suction pads	Air consumption* [l/min]	Max. suction flow [l/min]	Max. degree of evacuation [%]	Suction force** [N]	Weight [kg]
FXP-SVK 442 5R36 SPB2-20P	55	250	1,050	55	180	3.4
FXP-SVK 640 5R36 SPB2-20P	82	375	1,350	55	270	4.5
FXP-SVK 838 5R36 SPB2-20P	110	500	1,600	55	360	5.5
FXP-SVK 1234 5R36 SPB2-20P	165	875	2,940	55	540	7.6
FXP-SVK 1432 5R36 SPB2-20P	193	1,000	3,180	55	630	8.5
FXP-SW 442 5R36 SPB2-20P	55	250	1,050	55	140	3.3
FXP-SW 640 5R36 SPB2-20P	82	375	1,350	55	210	4.4
FXP-SW 838 5R36 SPB2-20P	110	500	1,600	55	280	5.4
FXP-SW 1234 5R36 SPB2-20P	165	875	2,940	55	420	7.5
FXP-SW 1432 5R36 SPB2-20P	193	1,000	3,180	55	490	8.4

Sound level: 74 dB(A)

Type	Number of suction pads	Required suction flow*** [l/min]	Suction force** [N]	Weight [kg]
FMP-SVK 442 5R36 SPB2-20P	55	300	180	3.3
FMP-SVK 640 5R36 SPB2-20P	82	450	270	4.4
FMP-SVK 838 5R36 SPB2-20P	110	600	360	5.4
FMP-SVK 1234 5R36 SPB2-20P	165	900	540	7.4
FMP-SVK 1432 5R36 SPB2-20P	193	1,050	630	8.3
FMP-SW 442 5R36 SPB2-20P	55	300	140	3.2
FMP-SW 640 5R36 SPB2-20P	82	450	210	4.3
FMP-SW 838 5R36 SPB2-20P	110	600	280	5.3
FMP-SW 1234 5R36 SPB2-20P	165	900	420	7.3
FMP-SW 1432 5R36 SPB2-20P	193	1,050	490	8.2

\*For compressed air with 5.5 bar input pressure

\*\*At -0.25 bar and with the gripper fully covered by a workpiece typical for the application (wooden board with structured surface)

\*\*\*The external vacuum generator used must supply at least the specified suction flow (at the vacuum connection piece of the FMP) at -0.25 bar but max. 135 % of the specified suction flow

# Vacuum Area Gripping Systems FXP / FMP

Design with Suction Pads ( $\varnothing = 20$  mm)

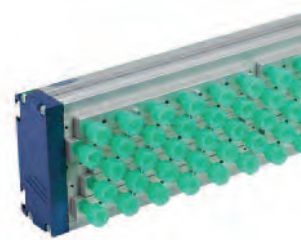

## Design Data FXP

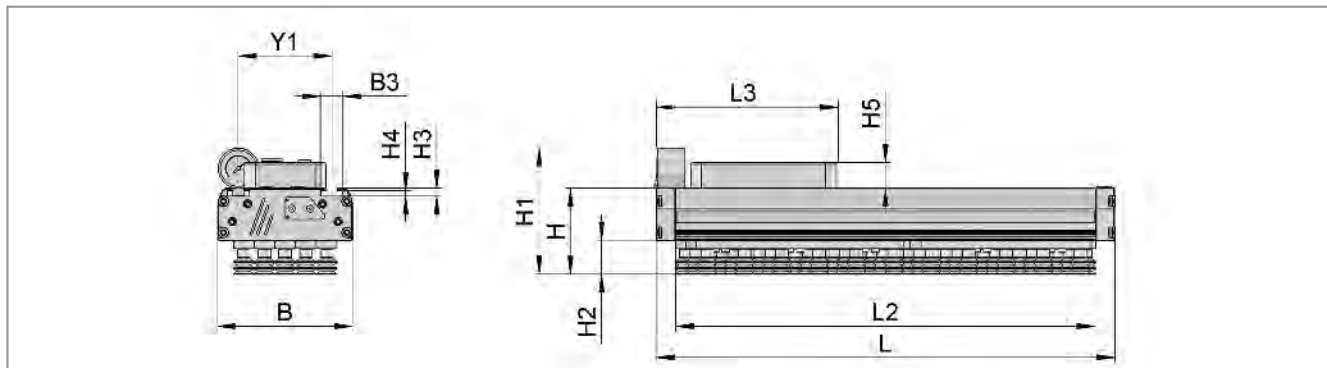

Type	Dimensions [mm]												
	B	B3	H	H1	H2*	H3	H4	H5	L	L2	L3	Y1	
FXP-SVK 442 5R36 SPB2-20P	130	21.6	83	124	33	7.7	5.5	28	442	404	154	90	
FXP-SVK 640 5R36 SPB2-20P	130	21.6	83	124	33	7.7	5.5	28	640	602	154	90	
FXP-SVK 838 5R36 SPB2-20P	130	21.6	83	129	33	7.7	5.5	28	838	800	154	90	
FXP-SVK 1234 5R36 SPB2-20P	130	21.6	83	129	33	7.7	5.5	28	1,234	1,196	154	90	
FXP-SVK 1432 5R36 SPB2-20P	130	21.6	83	129	33	7.7	5.5	28	1,432	1,394	154	90	
FXP-SW 442 5R36 SPB2-20P	130	21.6	83	124	33	7.7	5.5	28	442	404	154	90	
FXP-SW 640 5R36 SPB2-20P	130	21.6	83	124	33	7.7	5.5	28	640	602	154	90	
FXP-SW 838 5R36 SPB2-20P	130	21.6	83	129	33	7.7	5.5	28	838	800	154	90	
FXP-SW 1234 5R36 SPB2-20P	130	21.6	83	129	33	7.7	5.5	28	1,234	1,196	154	90	
FXP-SW 1432 5R36 SPB2-20P	130	21.6	83	129	33	7.7	5.5	28	1,432	1,394	154	90	

\*Permissible dimensional tolerances for elastomer parts according to DIN ISO 3302-1 M3

Note: Two ejectors/silencer box covers are used for the 1,234 mm and 1,432 mm lengths. Type FXP requires compressed air hose 12/9 mm

## Design Data FMP

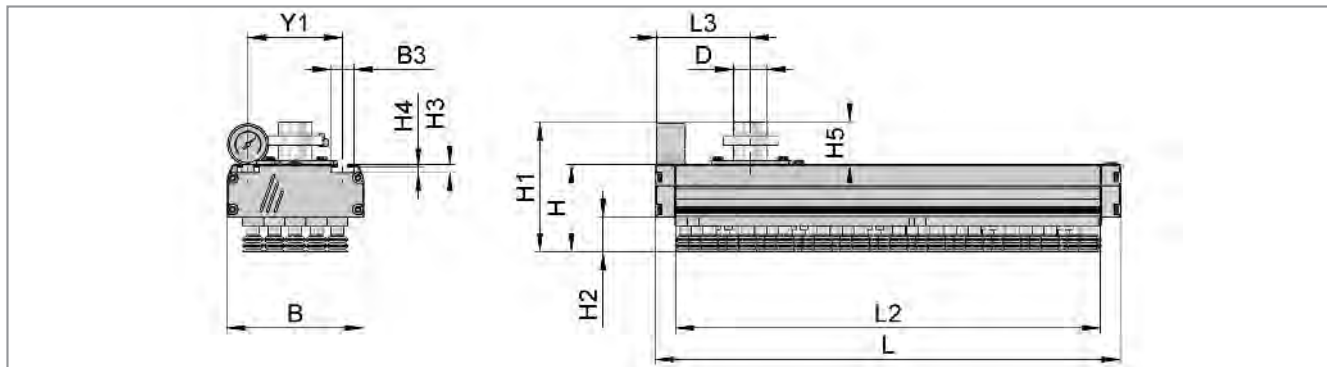

Type	Dimensions [mm]													
	B	B3	D	H	H1	H2*	H3	H4	H5	L	L2	L3	Y1	
FMP-SVK 442 5R36 SPB2-20P	130	21.6	32	83	124	33	7.7	5.5	41	442	404	90	90	
FMP-SVK 640 5R36 SPB2-20P	130	21.6	32	83	124	33	7.7	5.5	41	640	602	90	90	
FMP-SVK 838 5R36 SPB2-20P	130	21.6	60	83	129	33	7.7	5.5	46	838	800	90	90	
FMP-SVK 1234 5R36 SPB2-20P	130	21.6	60	83	129	33	7.7	5.5	46	1,234	1,196	90	90	
FMP-SVK 1432 5R36 SPB2-20P	130	21.6	60	83	129	33	7.7	5.5	46	1,432	1,394	90	90	
FMP-SW 442 5R36 SPB2-20P	130	21.6	32	83	124	33	7.7	5.5	41	442	404	90	90	
FMP-SW 640 5R36 SPB2-20P	130	21.6	32	83	124	33	7.7	5.5	41	640	602	90	90	
FMP-SW 838 5R36 SPB2-20P	130	21.6	60	83	129	33	7.7	5.5	46	838	800	90	90	
FMP-SW 1234 5R36 SPB2-20P	130	21.6	60	83	129	33	7.7	5.5	46	1,234	1,196	90	90	
FMP-SW 1432 5R36 SPB2-20P	130	21.6	60	83	129	33	7.7	5.5	46	1,432	1,394	90	90	

\*Permissible dimensional tolerances for elastomer parts according to DIN ISO 3302-1 M3

Note: Vacuum hose with internal diameter equal to dimension D required

# Vacuum Area Gripping Systems FXP / FMP

Design with Suction Pads ( $\varnothing = 40 \text{ mm}$ )

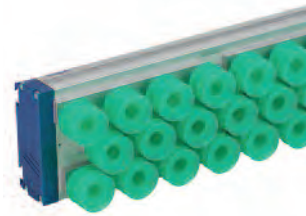

## Ordering Data for Area Gripping Systems

Type*	Part number		Type*	Part number	
	Without filter	With filter		Without filter	With filter
FXP-SVK 442 3R54 SPB2-40P	10.01.38.00715	10.01.38.00720	FMP-SVK 442 3R54 SPB2-40P	10.01.38.00311	10.01.38.00446
FXP-SVK 640 3R54 SPB2-40P	10.01.38.00716	10.01.38.00721	FMP-SVK 640 3R54 SPB2-40P	10.01.38.00439	10.01.38.00447
FXP-SVK 838 3R54 SPB2-40P	10.01.38.00717	10.01.38.00722	FMP-SVK 838 3R54 SPB2-40P	10.01.38.00443	10.01.38.00448
FXP-SVK 1234 3R54 SPB2-40P	10.01.38.00718	10.01.38.00723	FMP-SVK 1234 3R54 SPB2-40P	10.01.38.00444	10.01.38.00449
FXP-SVK 1432 3R54 SPB2-40P	10.01.38.00719	10.01.38.00724	FMP-SVK 1432 3R54 SPB2-40P	10.01.38.00445	10.01.38.00450
FXP-SW 442 3R54 SPB2-40P	10.01.38.00725	10.01.38.00730	FMP-SW 442 3R54 SPB2-40P	10.01.38.00451	10.01.38.00458
FXP-SW 640 3R54 SPB2-40P	10.01.38.00726	10.01.38.00731	FMP-SW 640 3R54 SPB2-40P	10.01.38.00453	10.01.38.00459
FXP-SW 838 3R54 SPB2-40P	10.01.38.00727	10.01.38.00732	FMP-SW 838 3R54 SPB2-40P	10.01.38.00455	10.01.38.00460
FXP-SW 1234 3R54 SPB2-40P	10.01.38.00728	10.01.38.00733	FMP-SW 1234 3R54 SPB2-40P	10.01.38.00456	10.01.38.00461
FXP-SW 1432 3R54 SPB2-40P	10.01.38.00729	10.01.38.00734	FMP-SW 1432 3R54 SPB2-40P	10.01.38.00457	10.01.38.00462

\*Customer-specific gripper dimensions on request

## Ordering Data for Suction Pads (Spare Parts)

Type	Part number		
		Without filter	With filter
SPB2 40 SI-55 P		10.01.06.03126	10.01.38.00452

Note: Other suction pad types (construction, material, diameter) available on request

## Technical Data

Type	Number of suction pads	Air consumption* [l/min]	Max. suction flow [l/min]	Max. degree of evacuation [%]	Suction force** [N]	Weight [kg]
FXP-SVK 442 3R54 SPB2-40P	23	250	1,050	55	250	3.1
FXP-SVK 640 3R54 SPB2-40P	33	375	1,350	55	360	4.2
FXP-SVK 838 3R54 SPB2-40P	44	500	1,600	55	480	5.2
FXP-SVK 1234 3R54 SPB2-40P	66	875	2,940	55	720	7.3
FXP-SVK 1432 3R54 SPB2-40P	77	1,000	3,180	55	840	8.2
FXP-SW 442 3R54 SPB2-40P	23	250	1,050	55	200	3.0
FXP-SW 640 3R54 SPB2-40P	33	375	1,350	55	290	4.1
FXP-SW 838 3R54 SPB2-40P	44	500	1,600	55	390	5.1
FXP-SW 1234 3R54 SPB2-40P	66	875	2,940	55	580	7.2
FXP-SW 1432 3R54 SPB2-40P	77	1,000	3,180	55	680	8.1

Sound level: 74 dB(A)

Type	Number of suction pads	Required suction flow*** [l/min]	Suction force** [N]	Weight [kg]
FMP-SVK 442 3R54 SPB2-40P	23	300	250	3.0
FMP-SVK 640 3R54 SPB2-40P	33	450	360	4.1
FMP-SVK 838 3R54 SPB2-40P	44	600	480	5.1
FMP-SVK 1234 3R54 SPB2-40P	66	900	720	7.1
FMP-SVK 1432 3R54 SPB2-40P	77	1,050	840	8.0
FMP-SW 442 3R54 SPB2-40P	23	300	200	2.9
FMP-SW 640 3R54 SPB2-40P	33	450	290	4.0
FMP-SW 838 3R54 SPB2-40P	44	600	390	5.0
FMP-SW 1234 3R54 SPB2-40P	66	900	580	7.0
FMP-SW 1432 3R54 SPB2-40P	77	1,050	680	7.9

\*For compressed air with 5.5 bar input pressure

\*\*At -0.25 bar and with the gripper fully covered by a workpiece typical for the application (wooden board with structured surface)

\*\*\*The external vacuum generator used must supply at least the specified suction flow (at the vacuum connection piece of the FMP) at -0.25 bar but max. 135 % of the specified suction flow

# Vacuum Area Gripping Systems FXP / FMP

Design with Suction Pads ( $\varnothing = 40$  mm)

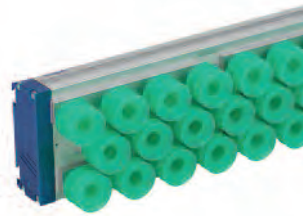

## Design Data FXP

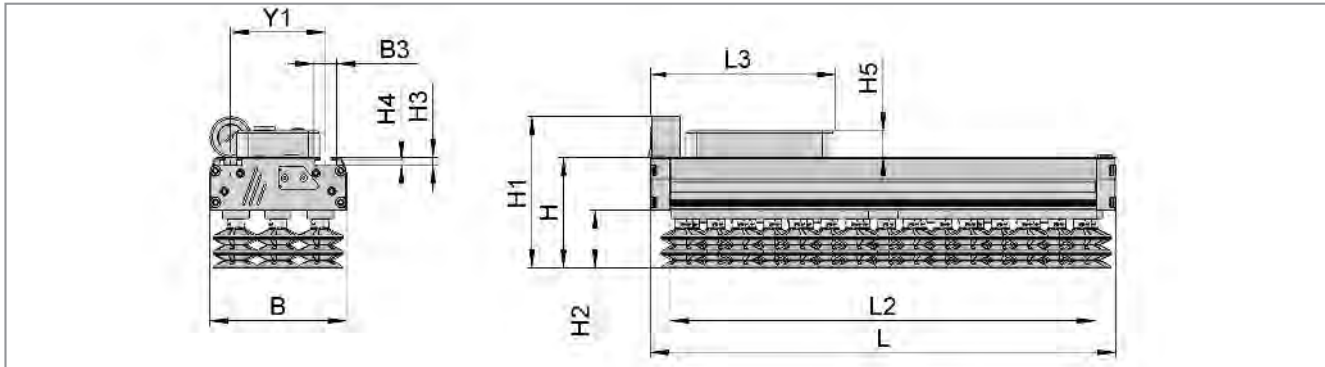

Type	Dimensions [mm]		H	H1	H2*	H3	H4	H5	L	L2	L3	Y1
	B	B3										
FXP-SVK 442 3R54 SPB2-40P	130	21.6	105	146	55	7.7	5.5	28	442	404	154	90
FXP-SVK 640 3R54 SPB2-40P	130	21.6	105	146	55	7.7	5.5	28	640	602	154	90
FXP-SVK 838 3R54 SPB2-40P	130	21.6	105	151	55	7.7	5.5	28	838	800	154	90
FXP-SVK 1234 3R54 SPB2-40P	130	21.6	105	151	55	7.7	5.5	28	1,234	1,196	154	90
FXP-SVK 1432 3R54 SPB2-40P	130	21.6	105	151	55	7.7	5.5	28	1,432	1,394	154	90
FXP-SW 442 3R54 SPB2-40P	130	21.6	105	146	55	7.7	5.5	28	442	404	154	90
FXP-SW 640 3R54 SPB2-40P	130	21.6	105	146	55	7.7	5.5	28	640	602	154	90
FXP-SW 838 3R54 SPB2-40P	130	21.6	105	151	55	7.7	5.5	28	838	800	154	90
FXP-SW 1234 3R54 SPB2-40P	130	21.6	105	151	55	7.7	5.5	28	1,234	1,196	154	90
FXP-SW 1432 3R54 SPB2-40P	130	21.6	105	151	55	7.7	5.5	28	1,432	1,394	154	90

\*Permissible dimensional tolerances for elastomer parts according to DIN ISO 3302-1 M3

Note: Two ejectors/silencer box covers are used for the 1,234 mm and 1,432 mm lengths. Type FXP requires compressed air hose 12/9 mm

## Design Data FMP

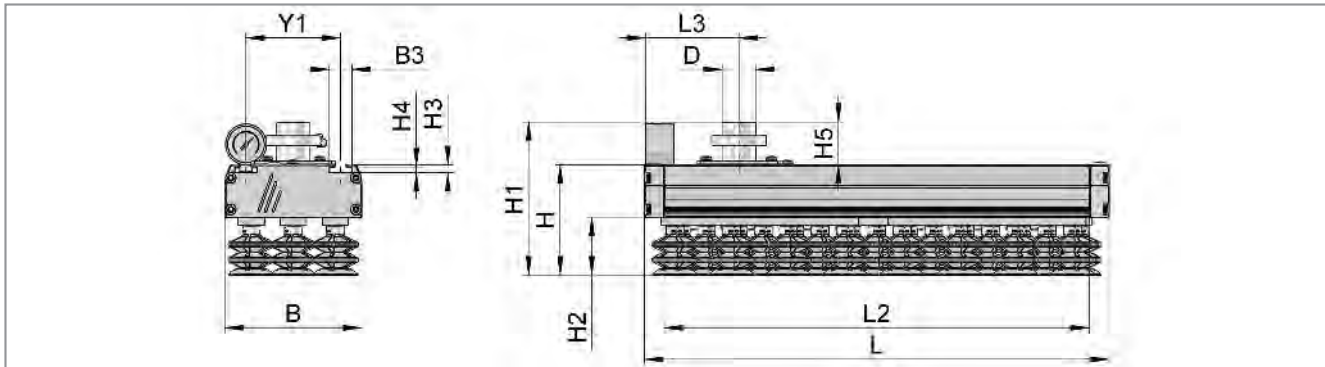

Type	Dimensions [mm]		D	H	H1	H2*	H3	H4	H5	L	L2	L3	Y1
	B	B3											
FMP-SVK 442 3R54 SPB2-40P	130	21.6	32	105	146	55	7.7	5.5	41	442	404	90	90
FMP-SVK 640 3R54 SPB2-40P	130	21.6	32	105	146	55	7.7	5.5	41	640	602	90	90
FMP-SVK 838 3R54 SPB2-40P	130	21.6	60	105	151	55	7.7	5.5	46	838	800	90	90
FMP-SVK 1234 3R54 SPB2-40P	130	21.6	60	105	151	55	7.7	5.5	46	1,234	1,196	90	90
FMP-SVK 1432 3R54 SPB2-40P	130	21.6	60	105	151	55	7.7	5.5	46	1,432	1,394	90	90
FMP-SW 442 3R54 SPB2-40P	130	21.6	32	105	146	55	7.7	5.5	41	442	404	90	90
FMP-SW 640 3R54 SPB2-40P	130	21.6	32	105	146	55	7.7	5.5	41	640	602	90	90
FMP-SW 838 3R54 SPB2-40P	130	21.6	60	105	151	55	7.7	5.5	46	838	800	90	90
FMP-SW 1234 3R54 SPB2-40P	130	21.6	60	105	151	55	7.7	5.5	46	1,234	1,196	90	90
FMP-SW 1432 3R54 SPB2-40P	130	21.6	60	105	151	55	7.7	5.5	46	1,432	1,394	90	90

\*Permissible dimensional tolerances for elastomer parts according to DIN ISO 3302-1 M3

Note: Vacuum hose with internal diameter equal to dimension D required



# Vacuum Area Gripping Systems FXP / FMP

## Accessories

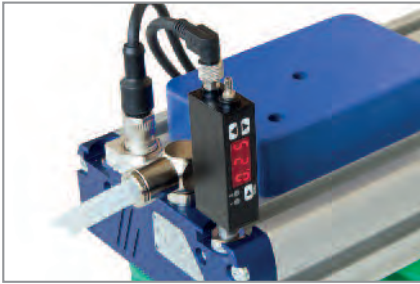

### Vacuum Switch

- Detection of the required vacuum and start of cycle by part present signal
- Optimization of cycle times
- Part number 10.06.02.00343

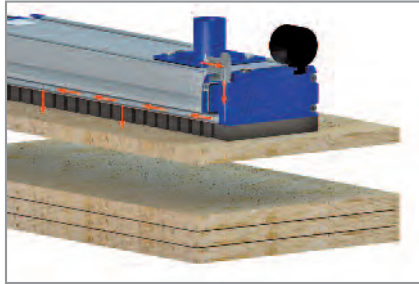

### Separation Function

- Separation of porous workpieces (e.g. boxes, MDF/particle boards) during destacking
- Active initiation of an adjustable, targeted compressed air pulse
- Part number on request

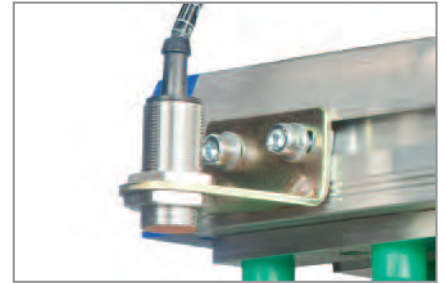

### Sensor Kit

- For workpiece and position detection
- Optimization of cycle times and increase in process reliability
- Includes attachment bracket
- Part number on request



### Attachment Kit Sliding Block

- 4 sliding blocks
- 4 screws (M8x16)
- Part number 10.01.21.00243

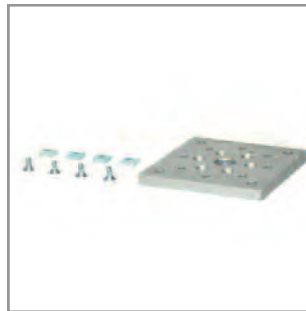

### Attachment Kit Flange Plate

- 1 flange plate
- Includes sliding block attachment kit
- Part number 10.01.21.01291



### Attachment Kit Double Flange Plate

- 1 double flange plate
- Includes sliding block attachment kit
- Part number 10.01.21.00244



### Attachment Kit Spring-Loaded Level Compensation

- 1 spring plunger (50 mm stroke) with jointed mounting
- Includes flange plate attachment kit
- Part number 10.01.21.02407

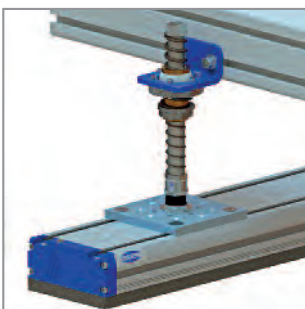

### Attachment Kit Flexible Level Compensation

- 1 spring plunger (50 mm stroke) with spherical bearing
- Maximum flexibility for uneven workpieces
- Self-centering and therefore no jamming
- Part number on request



### Cover Strip for T-Slots

- Positive-locking cover for the T-slots
- Easy cleaning
- Cable duct possible
- Available by the meter
- Part number 26.07.03.00002

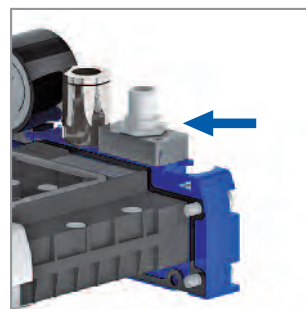

### Integrated Control Valves (for Type FXP-S)

- For switching vacuum and blow off on/off
- Minimum suction and blow off times
- Electrical connection via M12 plug (4-pole)
- Part number on request



### Solenoid Valve (for FMP Type)

- For switching blow off on/off
- Fast evacuation and minimization of cycle times
- Can be flange-mounted on the gripper
- Part number 10.01.21.02405

# Vacuum Area Gripping Systems FX / FM

Design with Sealing Foam (Height = 10 mm)

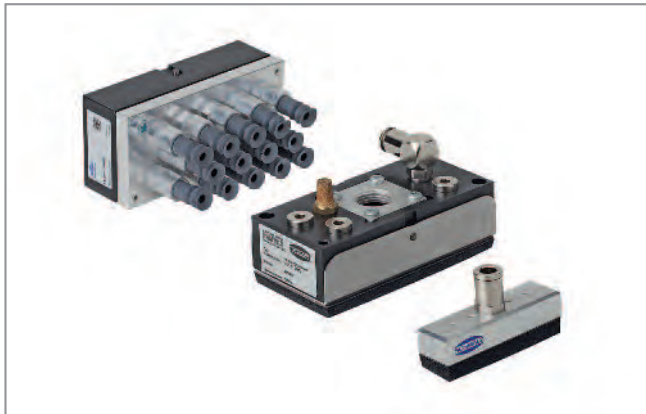

## The Small and Flexible Gripper

- For use in packaging processes for handling a wide range of products, e.g. filling boxes
- Ideal for integration in packaging machines (e.g. case packers) due to its compact dimensions and low weight
- For use on vacuum suction spiders for handling bending workpieces such as metal sheets and veneer
- FX type with integrated vacuum generation (ejector)
- FM type with connection for external vacuum generation

## Ordering Data

Type	Part number	Sealing foam (spare part)**
	Gripping system	
FX-SW 120x60	10.01.11.01802	10.01.10.00874
FX-SW 120x60 SEA*	10.01.11.01800	10.01.10.00874

Type	Part number	Sealing foam (spare part)**
	Gripping system	
FM-SW 76x22	10.01.11.00851	10.01.11.01388
FM-SW 120x60	10.01.11.01823	10.01.10.00874

\*Gripping system with blow off function for fast depositing of workpieces

\*\*Other foam heights and types on request

Note: Noise reduction possible by using an additional silencer (FX 120x60)

## Technical Data

Type	Number of suction cells	Air consumption* [l/min]	Max. suction flow [l/min]	Max. degree of evacuation [%]	Suction force** [N]	Weight [kg]
FX-SW 120x60	10	117	69	80	98	0.70
FX-SW 120x60 SEA	10	117	69	80	98	0.80
FM-SW 76x22	26	***	***	***	40	0.06
FM-SW 120x60	10	***	***	***	98	0.50

\*For compressed air with 5 bar input pressure

\*\*At -0.6 bar and with the gripper fully covered by a rigid workpiece

\*\*\*Depending on the external vacuum generation

## Design Data

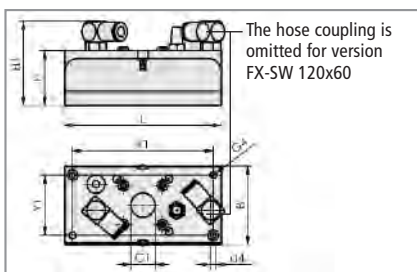

FX-SW 120x60 SEA

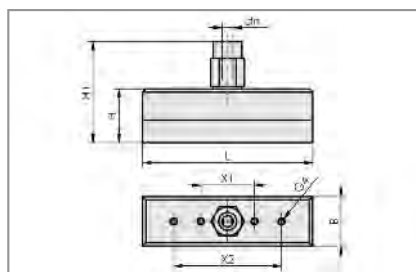

FM-SW 76x22

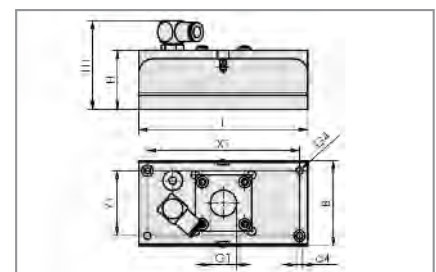

FM-SW 120x60

Type	Dimensions [mm]										
	B	d4	dn	G1	G4	H	H1	L	X1	X2	Y1
FX-SW 120x60	60	4.5	-	G <sup>1</sup> / <sub>2</sub> "-F	M6-F	42	63	120	108	-	46
FX-SW 120x60 SEA	60	4.5	-	G <sup>1</sup> / <sub>2</sub> "-F	M6-F	42	63	120	108	-	46
FM-SW 76x22	22	-	8	-	M3-F	24	35	76	24	48	-
FM-SW 120x60	60	4.5	-	G <sup>1</sup> / <sub>2</sub> "-F	M6-F	42	63	120	108	-	46

Note: The type FX requires an 8/6 mm compressed air hose; the type FM requires an 8/6 mm vacuum hose

# Vacuum Area Gripping Systems FX / FM

Design with Suction Pads ( $\varnothing = 12$  mm)

## Ordering Data

Type	Part number		Type	Part number	
	Gripping system	Suction pad (spare part)**		Gripping system	Suction pad (spare part)**
FX-SW 120x60 20 FSG12	10.01.11.02009	10.01.06.00558	FM-SW 120x60 20 FSG12	10.01.11.02010	10.01.06.00558
FX-SW 120x60 20 FSG12 SEA*	10.01.11.02008	10.01.06.00558			

\*Gripping system with blow off function for fast depositing of workpieces

\*\*Other suction pad types (construction, material) available on request

Note: Noise reduction possible by using an additional silencer (FX 120x60)

## Technical Data

Type	Number of suction pads	Air consumption* [l/min]	Max. suction flow [l/min]	Max. degree of evacuation [%]	Suction force** [N]	Weight [kg]
FX-SW 120x60 20 FSG12	14	117	69	80	12.6	1.0
FX-SW 120x60 20 FSG12 SEA	14	117	69	80	12.6	1.1
FM-SW 120x60 20 FSG12	14	***	***	***	12.6	0.8

\*For compressed air with 5 bar input pressure

\*\*At -0.6 bar and with the gripper fully covered by a rigid workpiece

\*\*\*Depending on the external vacuum generation

## Design Data

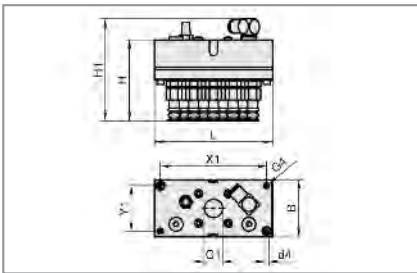

FX-SW 120x60 20 FSG12

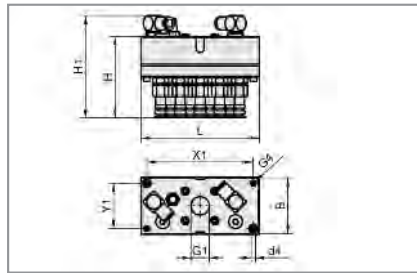

FX-SW 120x60 20 FSG12 SEA

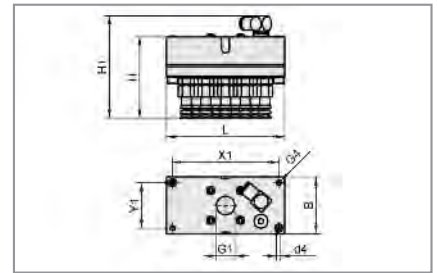

FM-SW 120x60 20 FSG12

Type	Dimensions [mm]								
	B	d4	G1	G4	H	H1	L	X1	Y1
FX-SW 120x60 20 FSG12	60	4.5	G <sup>1/2</sup> "-F	M6-F	82	103	120	108	46
FX-SW 120x60 20 FSG12 SEA	60	4.5	G <sup>1/2</sup> "-F	M6-F	82	103	120	108	46
FM-SW 120x60 20 FSG12	60	4.5	G <sup>1/2</sup> "-F	M6-F	82	103	120	108	46

Note: The FX type requires an 8/6 mm compressed air hose; the FM type requires an 8/6 mm vacuum hose

# Vacuum Area Gripping Systems SBX

Very Robust Grippers for the Timber and Woodworking Industry

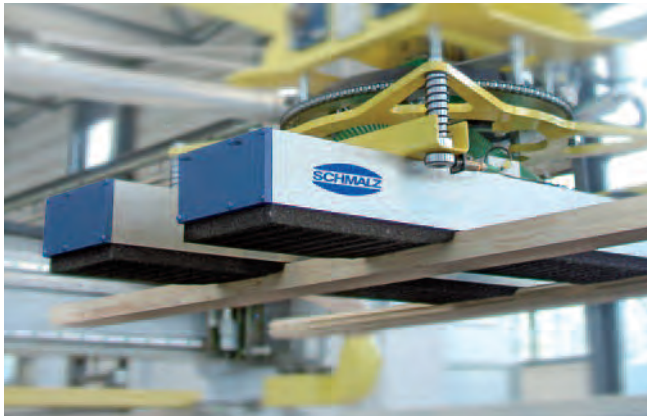

Vacuum area gripping system SBX

## Application

- Robust gripper for powerful handling of lumber, planed or glued timber, sheet materials, construction timber, pallets and crate elements
- Handling of naturally growing materials with knots or cracks or with warped, rough surfaces
- Ideal for the rough application conditions in saw mills or in woodworking and furniture construction
- Also suitable for unstacking and transporting workpieces in layers when in the double gripper configuration
- Ideal for operation with industrial robots and gantries due to its low weight and compact dimensions

## Design

### Aluminum base section

- Integrated vacuum reservoir
- High stiffness and low weight

### Compact valve unit

- With control valves, vacuum gauge, electrical and pneumatic connections
- Easily removed and therefore maintenance-friendly

### Vacuum generation

- Multi-stage ejector
- Connection for external vacuum generators as an option

### Dust filter

### Sealing foam

- Rebounds quickly and is resistant to wear due to the sandwich design
- Quick-change adhesive film

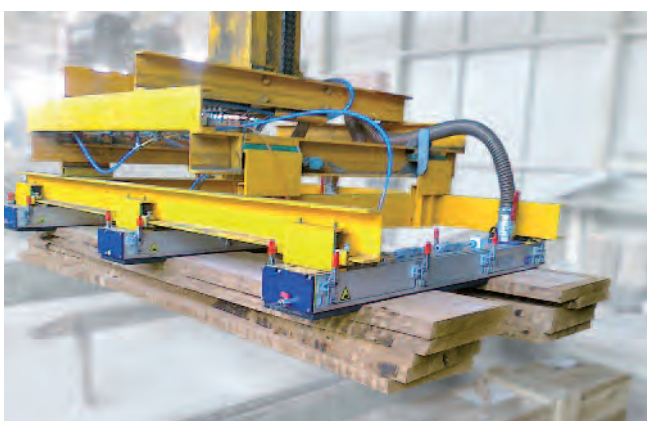

Vacuum area gripping systems SBX on an industrial gantry for handling unplaned wooden boards

## Your Benefits

- Extra high holding force for extremely porous and warped workpieces
- Automatic switching off of uncovered suction cells in order to sustain maximum system pressure
- Fast vacuum generation to minimize cycle times
- Maintenance-friendly due to compact valve unit and quick-change sealing foam
- Easy system integration due to pluggable connections
- Adaptation of the area gripper to the particular application case

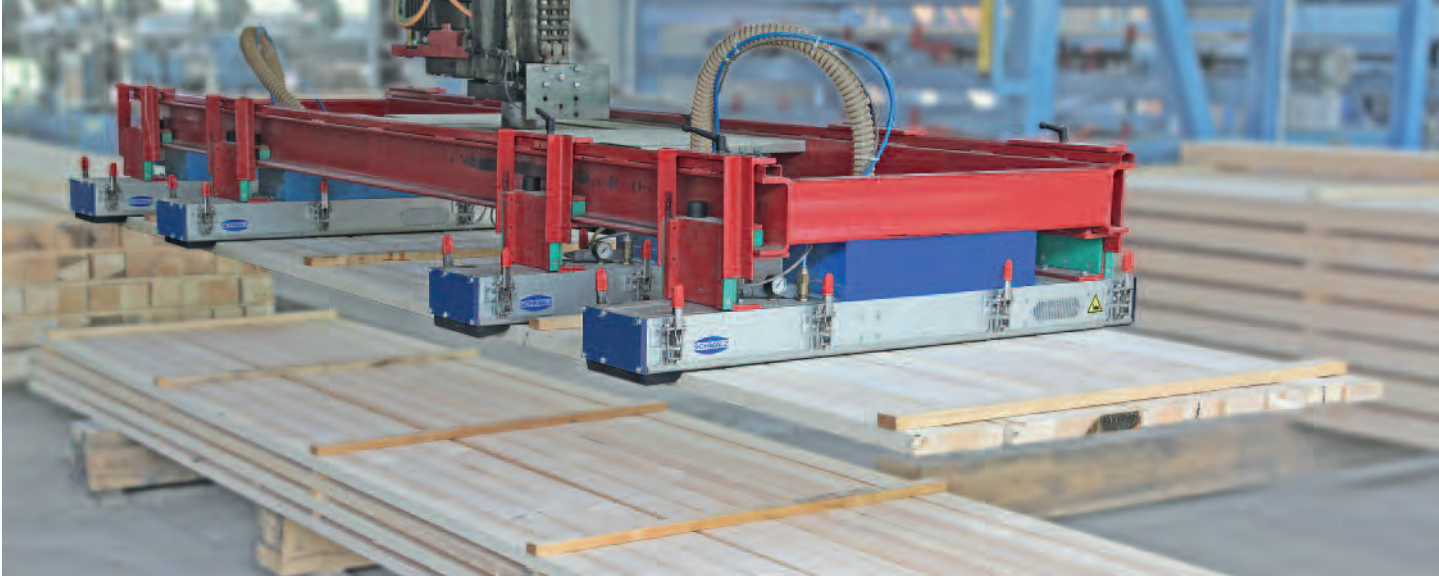

## Vacuum Area Gripping Systems SBX

### Types

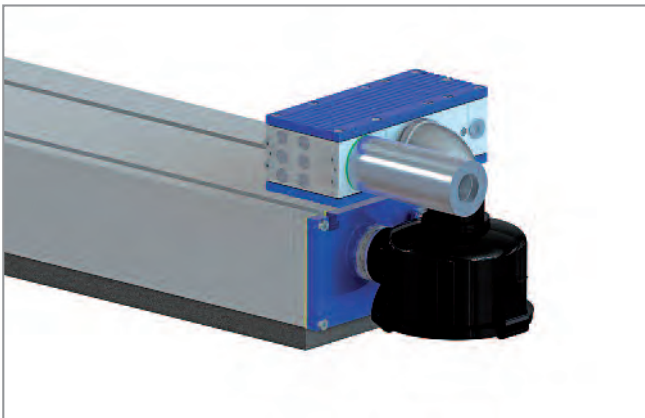

#### SBX 200 with Vacuum Generation

- Multi-stage ejector SEM 150 with dust filter
- Vacuum generation directly at the gripper ensures fast evacuation
- Easy mounting and installation without the need to connect additional hoses
- Ejector and dust filter can be optionally integrated into the base section

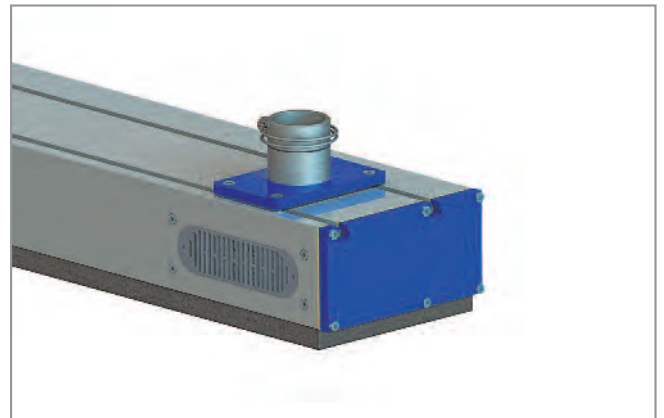

#### SBX 200 for External Vacuum Generation

- Connection piece for external vacuum generator
- Use of electrical vacuum generators (blower or pump) to achieve high flow rates and vacuums up to -0.8 bar
- Low operating costs due to electrical vacuum generation

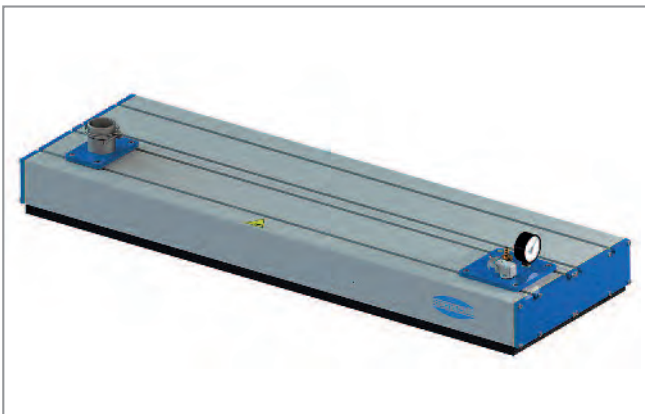

#### SBX 400 for External Vacuum Generation

- Double gripper design for maximum holding forces
- Increased hit rate due to offset suction cell grid, thus particularly suited for thin workpieces
- Use of electrical vacuum generators (blower or pump) to achieve high flow rates and vacuums up to -0.8 bar

# Vacuum Area Gripping Systems SBX

## Accessories

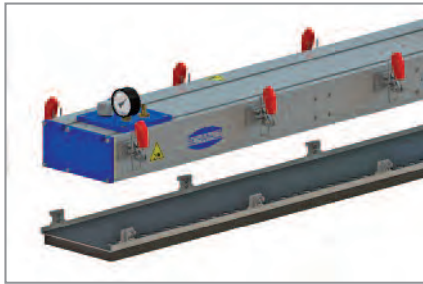

### Quick-Change Plate

- Quick and easy changing of the sealing plate using quick-release clamp
- Allows soaked or frozen sealing plates to be used again after drying

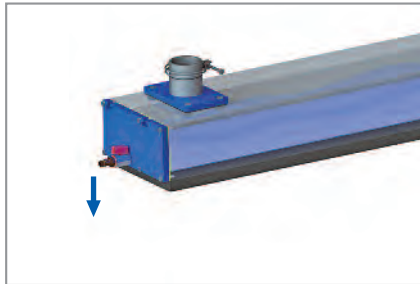

### Water Removal System

- Reliably removes any water that is sucked into the gripper
- Increased process reliability for wet workpieces
- Basic version: manually operated valve
- Advanced version: electrically operated valve

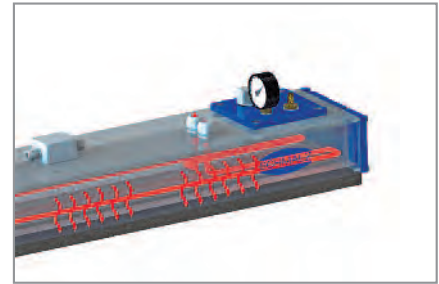

### Heating System

- The area gripper is slightly heated by a heating system
- Prevents moisture from freezing on the gripper when temperatures are low in outdoor applications

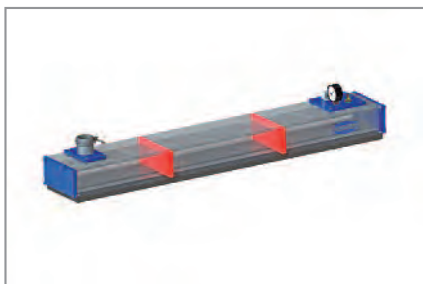

### Gripper Segmentation

- Sectioning of the gripper into multiple suction zones that can be adjusted as needed and asynchronously controlled
- Prevents intermediate layers from being picked up inadvertently
- Min. zone size of 315 mm (for standard grid)

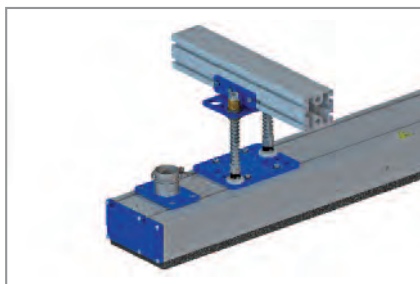

### Spring-Loaded Level Compensation

- Quick mounting on beams and gantries
- Jointed / spring-loaded design for optimal height compensation and gentle setting down on the workpiece

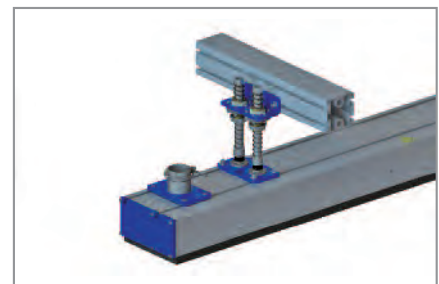

### Flexible Level Compensation

- Spring plunger with spherical bearing
- Maximum flexibility for extremely uneven layers of workpieces
- Responsive in all directions
- Self-centering and therefore no jamming

## Designation Code

Designation code explained using the example of: SBX-C 1040x200 35 25 SEM-150

SBX	C	1040x200	35	25	SEM-150
Type	Version	Length x width [mm]	Suction cell grid distance [mm]	Foam height [mm]	Vacuum generation
SBX	C With compact valve unit	1,040 x 200	35	25	SEM-150 Multi-stage ejector
SBX	C With compact valve unit	1,040 x 200 1,250 x 200 1,040 x 400 1,250 x 400	35 Moderate (standard) 28 Fine (on request)	25	SEM-150 Multi-stage ejector - External vacuum generation (pump or blower)

# Vacuum Area Gripping Systems SBX

## Product Specifications

### Ordering Data

Type*	Part number	Gripping system	Sealing plate** (spare part)
SBX-C 1040x200 35 25 SEM-150		10.01.20.01000	10.01.20.01006
SBX-C 1250x200 35 25 SEM-150		10.01.20.01001	10.01.20.00438
SBX-C 1040x200 35 25		10.01.20.01002	10.01.20.01006
SBX-C 1250x200 35 25		10.01.20.01003	10.01.20.00438
SBX-C 1040x400 35 25		10.01.20.01004	10.01.20.01007
SBX-C 1250x400 35 25		10.01.20.01005	10.01.20.00440

\*Customer-specific gripper dimensions on request

\*\*Other foam heights and foam types on request

### Technical Data

Type	Vacuum generation	Number of suction cells	Air consumption [l/min]	Max. suction flow [l/min]	Max. degree of evacuation [%]	Suction force** [N]	Weight [kg]
SBX-C 1040x200 35 25 SEM-150*	Ejector	29	640	1,400	80	2,400	25
SBX-C 1250x200 35 25 SEM-150*	Ejector	35	640	1,400	80	3,000	28
SBX-C 1040x200 35 25	Blower / Pump	29	***	***	***	2,400	23
SBX-C 1250x200 35 25	Blower / Pump	35	***	***	***	3,000	26
SBX-C 1040x400 35 25	Blower / Pump	57	***	***	***	4,500	46
SBX-C 1250x400 35 25	Blower / Pump	69	***	***	***	5,900	52

\*Sound level 78 dB(A)

\*\*At -0.25 bar and with full gripper coverage

\*\*\*Depending on the external vacuum generation

### Design Data

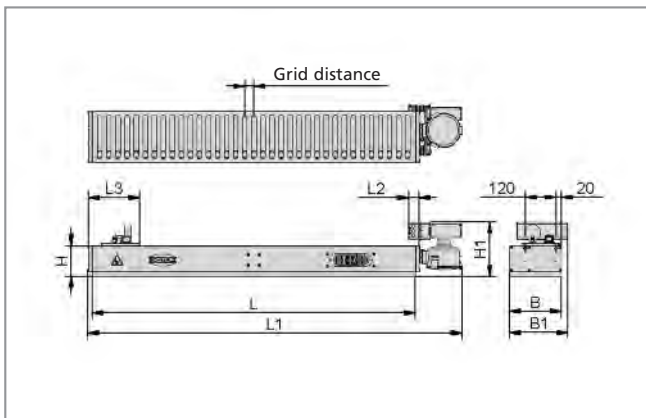

SBX with vacuum generator (SEM-150)

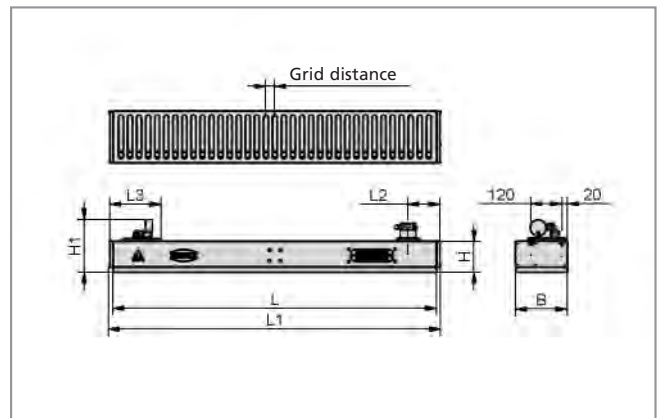

SBX with connection for external vacuum generator

Type	Dimensions [mm]							
	H	H1	B	B1	L	L1	L2	L3
SBX-C 1040x200 35 25 SEM-150	125	217.0	200	225.5	1040	1234	41	185
SBX-C 1250x200 35 25 SEM-150	125	217.0	200	225.5	1250	1444	41	185
SBX-C 1040x200 35 25	125	207.5	200	-	1040	1075	123	185
SBX-C 1250x200 35 25	125	207.5	200	-	1250	1285	123	185
SBX-C 1040x400 35 25	125	207.5	400	-	1040	1075	123	185
SBX-C 1250x400 35 25	125	207.5	400	-	1250	1285	123	185

Note: Type SBX requires compressed air hose 15/9 mm



## Vacuum Layer Gripping Systems

### High-Performance Palletizers for Warehousing and Intralogistics

Together with capable palletizing robots and gantries, vacuum layer gripping systems from Schmalz increase the production output in the automated handling of products in various industries. Individually planned systems guarantee an optimal process integration and ensure a quick return on investment.



# Vacuum Layer Gripping Systems SPZ

Grips Everything that Comes Along



Vacuum Layer Gripping Systems SPZ

## Application

- Palletizing and de-palletizing of layers of various goods
- Use in warehouse logistics and intralogistics
- Handling of layers with gaps, mixed layers, intermediate layers, pallets, cardboard packaging and film packaging
- Palletizing and de-palletizing partial pallets by the combination of vacuum technology and mechanical gripping support

## Design

### Flange connection

- Spring-loaded level compensation (floating attachment) to all common robots and gantries

### Control modules

- For common bus systems available; decentral control

### Basic body / suction box

- Height adjustable by servomotor (optional)

### Suction area

- With suction pads

### External vacuum generation (not shown)

- Individually selected from the Schmalz program

## Your Benefits

- Secure and damage free gripping of various layer sizes and layer patterns
- Higher throughput due to process acceleration
- No gripper changeover and set-up times when performing job changes
- Innovative gripping concept with mechanical support and global vacuum for additional holding force
- Use in the freezer industry sector in areas down to -30 °C (optional)
- Skilled system design according to individual requirements

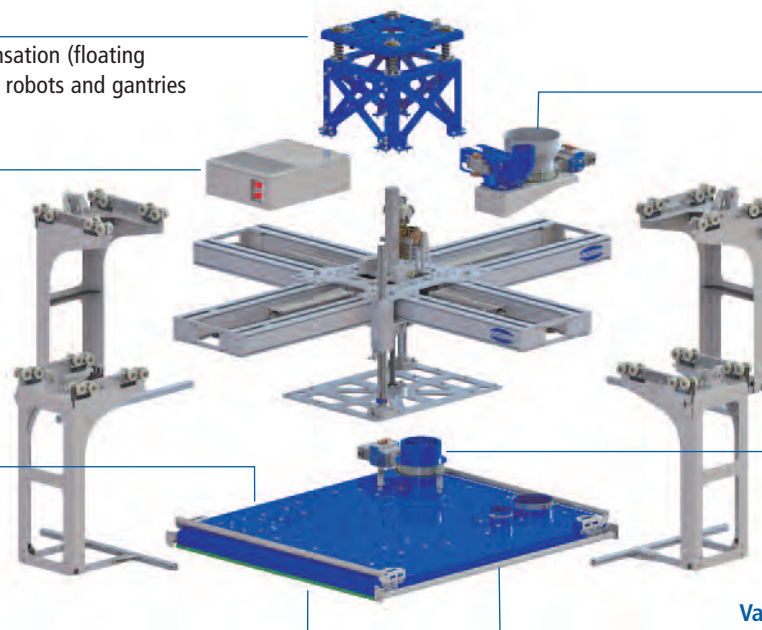

### Vacuum valves

- For suction area / global vacuum

### Mechanical gripping modules

- Servomotor-driven (pneumatically as an option)

### Venting valve

### Vacuum curtain (retracted)

- For generating a global vacuum

# Vacuum Layer Gripping Systems SPZ

## Types and Gripping Technology

### Basic Configurations

The layer gripping system SPZ is available in three basic configurations, differing in their gripping technology.

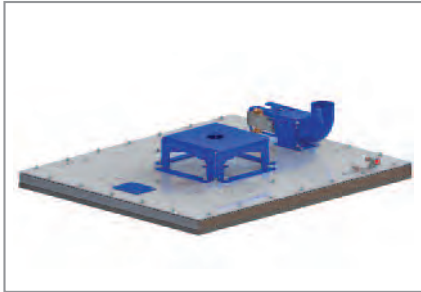

#### SPZ with Vacuum Suction Area

- Sealing foam for homogenous and intrinsically stable product layers, such as jars and cans
- Suction pads for flexible workpieces



#### SPZ-M with Mechanical Gripping Support

- Additional stabilization of instable and porous product layers, such as cardboard boxes and beverage trays



#### SPZ-M-C with Global Vacuum

- Maximum holding force for product layers that cannot be "sucked" (e.g. mixed layers and layers with gaps)

### Industry-Specific Versions

Schmalz has developed specific layer gripping systems for typical applications of particular industries.

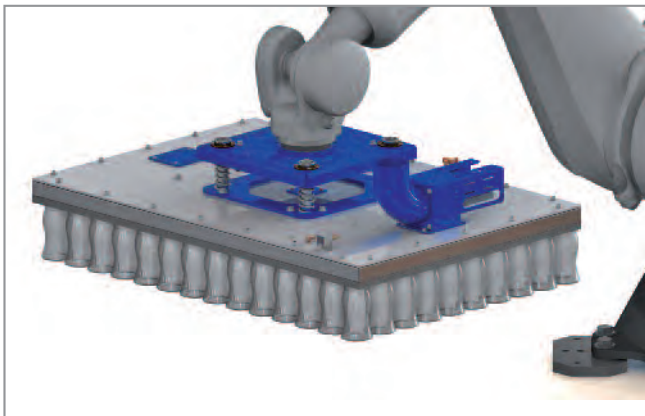

**SPZ Glass** | Palletizing and de-palletizing of jars and cans



**SPZ Packaging** | Palletizing and de-palletizing of cardboard boxes, beverage trays etc.



**SPZ Logistics** | Handling of various product layers in warehousing and intralogistics



**SPZ Nesting** | De-stacking of cut-optimized wooden or metal sheets in a single handling process

# Vacuum Layer Gripping Systems SPZ

## Product Specifications

### Innovative Expansion Options

In order to optimize cycle times, energy consumption and process safety, the layer gripping systems can be equipped with various additional features and thus be adapted to process-specific requirements.

- **Sensor Unit**

Optimization of cycle times and increased process safety due to vacuum detection and parts control

- **Energy Saving Version**

Reduced energy consumption due to workpiece and process-dependent blower regulation (by frequency converter)

- **Collision Detection**

Avoidance of damages on the workpieces and system standstills due to floating attachment with collision monitoring

- **Intermediate Layer Separation**

Process-safe separation of various intermediate layers

- **Deep-Freezing Version**

Suitable for use at temperatures down to -30 °C

- **Mechanical Pallet Gripping Arms**

Safe handling of one or more pallets, servomotor-driven

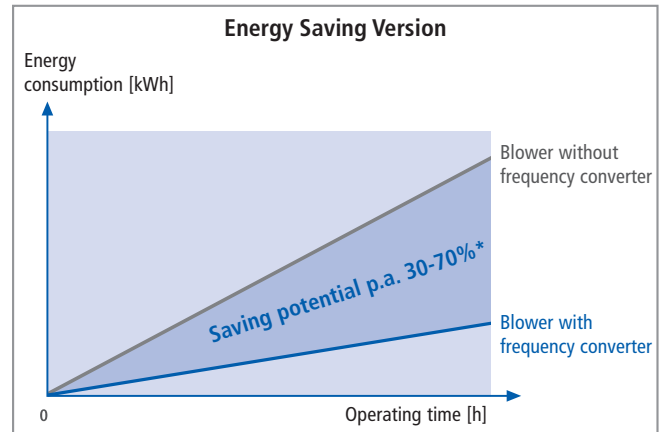

\*The energy savings are dependent on many factors (cycle, handling process, safety factor, porosity of workpiece, etc.) and must always be determined individually

### Technical Data



Every layer gripping system can be adapted to individual requirements. The following data are therefore reference values and may vary depending on the application. Suction tests with original workpieces are always required to ensure functionality. We perform these in our test center individually for your application.

Type	Gripping technology			Gripper dimensions* [mm]	Gripper weight [kg]	Max. layer weight [kg]	Pallet size** [mm]	Temperature operating range [°C]
	Vacuum suction area	Mech. gripping support	Global vacuum					
SPZ	✓			approx. 1,250x850x275	approx. 90	250	Euro (1,200x800)	+5 to +40
SPZ-M	✓	✓		approx. 2,100x1,800x1,000	approx. 390	250	Industry (1,200x1,000)	(down to -30
SPZ-M-C	✓***	✓	✓	approx. 2,100x1,800x1,000	approx. 390	250	US (1,015 x1,215)	on request)

\*Gripper dimensions may vary depending on the pallet size

\*\*Special sizes on request

\*\*\*Type SPZ-M-C can be optionally equipped without suction area. Handling of the workpieces is then performed by the mechanical gripping and the global vacuum



## Vacuum Suction Spiders

### Custom Made Solutions for End-of-Arm-Tooling

You supply the robot, and we take care of the gripping technology. Selecting from a range of more than 3,500 standard components, our application engineers develop, design and build future-proof solutions to meet your individual requirements.

# Vacuum Suction Spiders SSP

## Robot Grippers Made-to-Measure

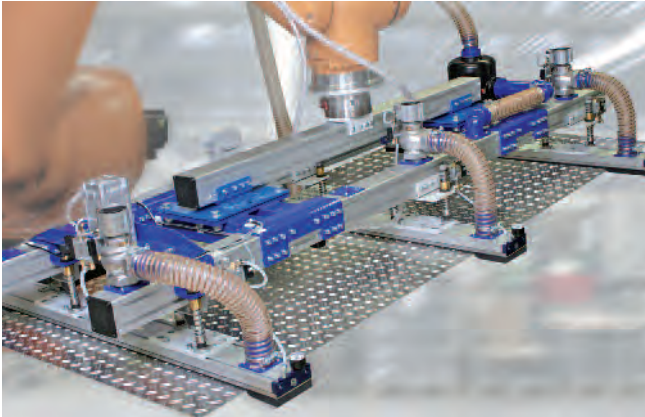

Vacuum suction spider SSP being used to handle metal sheets

### Application

- Automation of handling tasks in manufacturing, assembly and quality control processes
- Linking robots in presses and bending centers
- Automating plastic injection molding machines, deep drawing machines, machining centers for wood and plastics, water jet machines, laser machines and punching machines
- Order picking in storage and distribution centers on industrial robots or gantries
- Handling of metal sections, blanks, stone, sheet materials, car body parts, glass and ceramic components, etc.

### Design

The figure shows the basic design of the suction spider SSP. On request, individual configurations with many extensions are possible.

#### Flange module

- For connection to common robots and gantries
- Rigid or spring-loaded level compensator (floating attachment)

#### Aluminum main beam

- High stiffness and low weight
- Integrated vacuum distribution and reservoir

#### Valve technology

#### Area grippers or suction pads

- Individually selected from the Schmalz program

#### Vacuum generation

- Individually selected from the Schmalz program

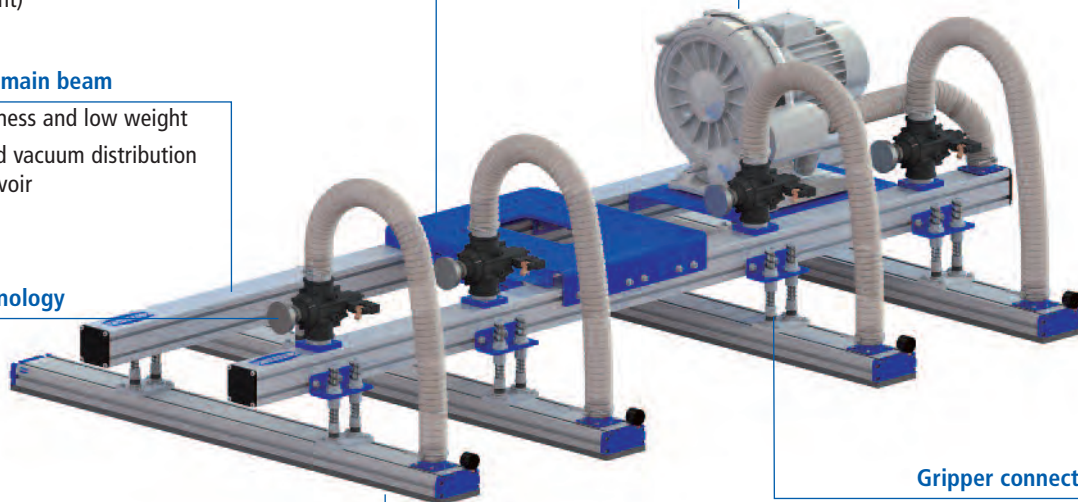

#### Gripper connection

- Rigid or spring-loaded and jointed level compensator
- For optimal height adjustment

### Your Benefits

- Modular system with standardized and harmonized components
- Flexible adaptation to customer-specific requirements
- Combination of different gripping technologies (vacuum, mechanics, magnetics etc.) possible
- Low intrinsic weight due to basic components made of aluminum, steel pipe and plastics
- Minimization of cycle times
- Enhanced process safety due to integrated system monitoring and sensor technology
- Intelligent valve modules for unused suction pads

# Vacuum Suction Spiders SSP

## Individual Configuration

### Customer-Specific Versions

Vacuum suction spider SSP from Schmalz can be custom configured.

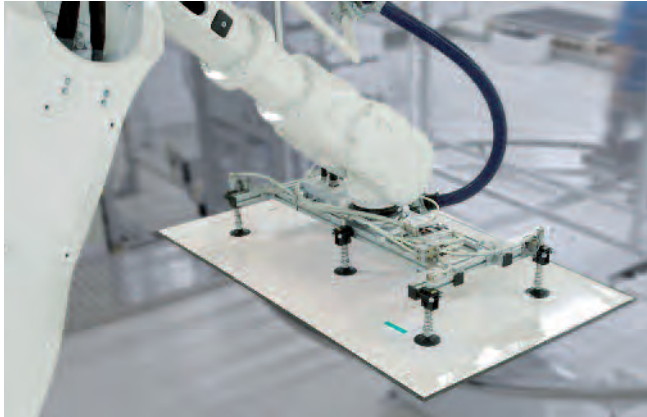

Vacuum suction spider SSP being used to handle module glass



Vacuum suction spider SSP being used to handle cut metal sheets

### Innovative Expansion Options

- **Sensor Unit**  
Optimization of cycle times and increased process safety due to vacuum detection and parts control
- **Energy Saving Version**  
Reduced energy consumption due to workpiece and process dependent regulation of the vacuum generator
- **Separation Function**  
Safe separation of porous workpieces such as chipboards
- **Peeling Unit**  
Reliable separation of smooth and airtight workpieces such as sheets of glass
- **Plug & Play Function**  
Electrical terminal box with multi-pin connection plugs enables quick and easy installation



### Vacuum End Effectors VEE for the Packaging Industry

System components for quick and cost-effective designing of vacuum end effectors for high-speed packaging processes:

- Perfectly coordinated individual components
- Lightweight design for high-speed applications
- Online configurator minimizes designing effort
- Max. lift capacity 2,000 g

# Contact

On-Site Competence in More Than 50 Countries Worldwide

## Canada

Schmalz Vacuum Technology Ltd.  
17-3190 Ridgeway Drive  
ON L5L 5S8 Mississauga  
Ontario

Tel. +1 905 569-9520  
Fax +1 905 569-8256  
schmalz@schmalz.ca



## India

Schmalz India Pvt. Ltd.  
EL - 38 J Block MIDC  
Bhosari  
411026 Pune

Tel. +91 (0)20 4072-5500  
Fax +91 (0)20 4072-5588  
schmalz@schmalz.co.in

## United States

Schmalz Inc.  
5200 Atlantic Avenue  
Raleigh, NC 27616

Tel. +1 919 713-0880  
Fax +1 919 713-0883  
schmalz@schmalz.us



## Worldwide

**Headquarters in Germany**  
J. Schmalz GmbH  
Aacher Strasse 29  
72293 Glatten

Tel. +49 (0)7443 2403-0  
Fax +49 (0)7443 2403-259  
schmalz@schmalz.de

You can find contact information for our trade partners in 50 countries at [www.schmalz.com/salesnetwork](http://www.schmalz.com/salesnetwork)

## Questionnaire for a Fast Project Start

Our questionnaire enables you to easily prepare yourself for the project planning discussion with the Schmalz system consultant and accelerates a technically well-grounded creation of offers:  
[www.schmalz.com/product-inquiry](http://www.schmalz.com/product-inquiry)

**Vacuum Gripping Systems (VG)**  
**Questionnaire to Create an Offer**

**Remark:** Dear customer, this form helps to quote faster and have a technical correct project management. Please fill out all available data.

**1. Contact Information**

Company: \_\_\_\_\_ Contact person: \_\_\_\_\_  
 Department: \_\_\_\_\_ Phone: \_\_\_\_\_  
 Street No.: \_\_\_\_\_ Fax: \_\_\_\_\_  
 Zip-code: \_\_\_\_\_ E-mail: \_\_\_\_\_  
 City, country: \_\_\_\_\_ Type of request:  Hot  Email  Phone  \_\_\_\_\_  
 Date: \_\_\_\_\_ Other: \_\_\_\_\_

**2. Workplace**

**Workplace description**

2.1 Shape of the workplace

Shape: \_\_\_\_\_

Dimensions:

	W	H	D	W	H	D	W	H	Weight
Max.									
Min.									
Dimensions									

Material: material 1: \_\_\_\_\_ density: \_\_\_\_\_ (kg/m³)  
 material 2: \_\_\_\_\_ density: \_\_\_\_\_ (kg/m³)

Surface:  flat  rough  irregular

Finishing:  coarse  dry  wet  oily  heavy  \_\_\_\_\_  
 specification: \_\_\_\_\_

Section density:  non porous  porous  
 specification: \_\_\_\_\_

© J. Schmalz GmbH  
 Aacher Strasse 29  
 72293 Glatten  
 Tel. +49 (0)7443 2403-0  
 Fax +49 (0)7443 2403-259  
 schmalz@schmalz.de  
 www.schmalz.com



**Vacuum Components**

Tel. +49 (0)7443 2403-102



**Vacuum Gripping Systems**

Tel. +49 (0)7443 2403-107



**Vacuum Handling Systems**

Tel. +49 (0)7443 2403-108



**Vacuum Clamping Systems**

Tel. +49 (0)7443 2403-109

## Schmalz Worldwide

### Canada

Schmalz Vacuum  
Technology Ltd.  
Mississauga  
schmalz@schmalz.ca

### China

Schmalz (Shanghai) Co. Ltd.  
Shanghai  
schmalz@schmalz.net.cn

### Finland

Oy Schmalz Ab  
Vantaa  
schmalz@schmalz.fi

### France

Schmalz S.A.S.  
Champs sur Marne  
schmalz@schmalz.fr

### Germany

J. Schmalz GmbH  
Glatten  
schmalz@schmalz.de

### India

Schmalz India Pvt. Ltd.  
Pune  
schmalz@schmalz.co.in

### Italy

Schmalz S.r.l. a Socio Unico  
Novara  
schmalz@schmalz.it

### Japan

Schmalz K.K.  
Yokohama  
schmalz@schmalz.co.jp

### The Netherlands

Schmalz B.V.  
Hengelo  
schmalz@schmalz.nl

### Poland

Schmalz Sp. z o.o.  
Warsaw  
schmalz@schmalz.pl

### Russia

Schmalz Representation  
Moscow  
schmalz@schmalz.ru

### South Korea

Schmalz Co. Ltd.  
Seoul  
schmalz@schmalz.co.kr

### Spain

Schmalz S.A.  
Erandio (Biscay)  
schmalz@schmalz.es

### Switzerland

Schmalz GmbH  
Nürensdorf  
schmalz@schmalz.ch

### Turkey

Schmalz Vakum  
San. ve Tic. Ltd. Şti.  
Istanbul  
schmalz@schmalz.com.tr

### United States

Schmalz Inc.  
Raleigh  
schmalz@schmalz.us

Find your local sales partner by visiting  
[www.schmalz.com/salesnetwork](http://www.schmalz.com/salesnetwork)

Scan code to access  
the digital brochure



**J. Schmalz GmbH**  
Aacher Strasse 29  
D-72293 Glatten  
Tel. +49 (0)7443 2403-0  
Fax +49 (0)7443 2403-259  
schmalz@schmalz.de  
[www.schmalz.com](http://www.schmalz.com)