

Product range



siegling proposition
timing belts

siegling proposition

timing belts

In modern power-transmission and handling technology, timing belts are versatile components for positioning, conveying, synchronising, interval conveying and singling.

As form-fit power-transmission and conveying components, Siegling Proposition timing belts complement the established family of Siegling Transilon conveying and processing belts. Our vast experience in light materials handling guarantees superb product quality, in-depth support and fast service.

Siegling Proposition high-efficiency timing belts are made of high-quality polyurethane with an embedded tension member made of steel cord or Kevlar. Thanks to their low mass and extreme tensile strength, they are quiet to operate and require virtually no maintenance. These characteristics make them ideal for demanding tasks like accelerating and braking, as well as for exact positioning.

A wide range of coatings, patterns and profiles can be applied to standard timing belts. They can be modified even further by adding perforations, milling and grinding. As a result, the belts are true specialists when dealing with conveying, power-transmission or handling jobs.

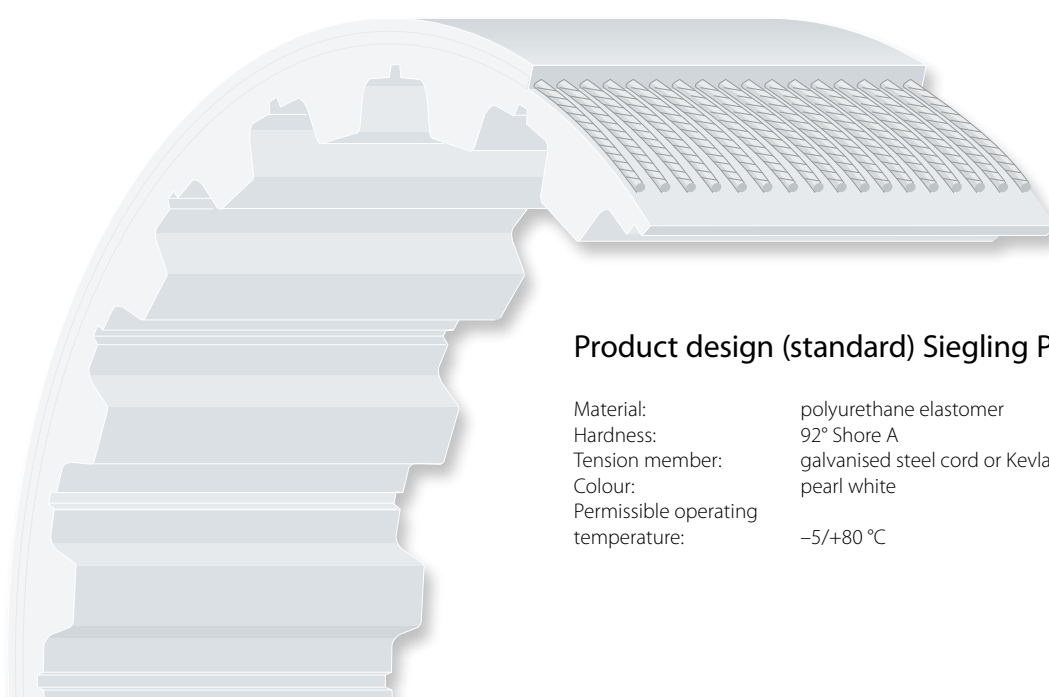

Product design (standard) Siegling Proposition

Material:	polyurethane elastomer
Hardness:	92° Shore A
Tension member:	galvanised steel cord or Kevlar
Colour:	pearl white
Permissible operating temperature:	-5/+80 °C



Contents

Siegling Proposition applications	4
Standard product range	6
Cams and profiles	9
Coatings and coverings	10
Customised products	12
Accessories	
Endless splices	14

The properties

The advantages

wear-resistant	▶	long belt life
maintenance-free	▶	no maintenance costs
good tracking properties	▶	reliable, gentle operation
low noise	▶	safe working conditions
flexible	▶	small reversing diameters, high counter-bending strength
saves room	▶	compact machine designs possible



MOVEMENT SYSTEMS

Siegling Proposition applications

Linear drives

Thanks to form-fit transmission and narrow fabrication tolerances, Siegling Proposition timing belts guarantee isogonic rotations and high repeat accuracy in linear drives. ATL timing belts are especially good at meeting these challenges.



Siegling Proposition on the power test rig.

Automation and handling technology

In automation and handling technology, Siegling Proposition timing belts are often used in place of chains and other systems which require complex designs.



Siegling Proposition belts in a packaging machine.

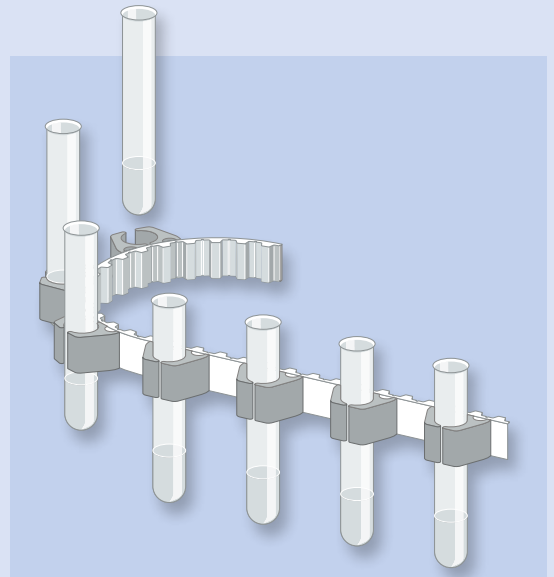
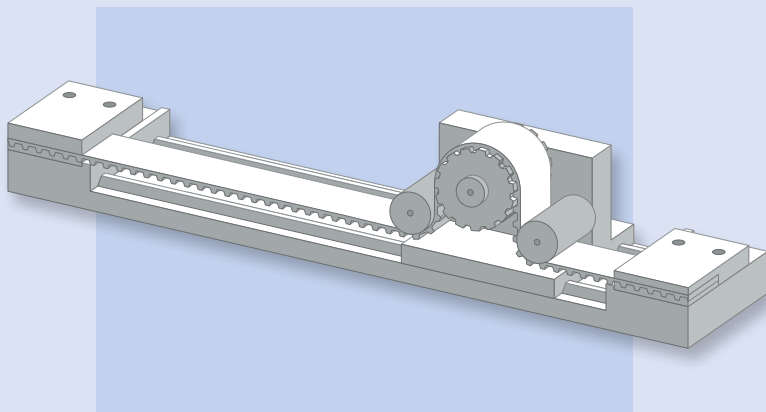

Lifting devices, portal robots and roll-up door drives

In lifting devices, portal robots and roll-up door drives, Siegling Proposition timing belts transmit large forces while providing a high degree of positioning accuracy.



Siegling Proposition timing belts in the vertical axis of an industrial robot.

Synchronous operation

As conveyor belts running synchronously in sets, they guarantee that the goods being conveyed remain in position. Cams, coatings and coverings make it possible to customise the belts precisely for the goods being conveyed and the conveying task.



Conveying of car windows by belts running synchronously. The coverings on the reverse face of the timing belts treat the goods gently and improve the grip.

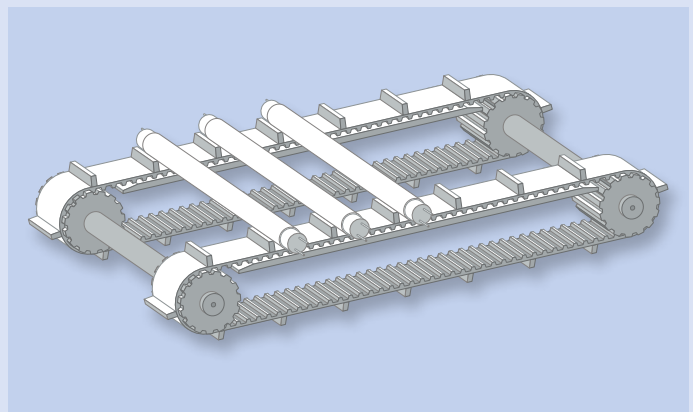
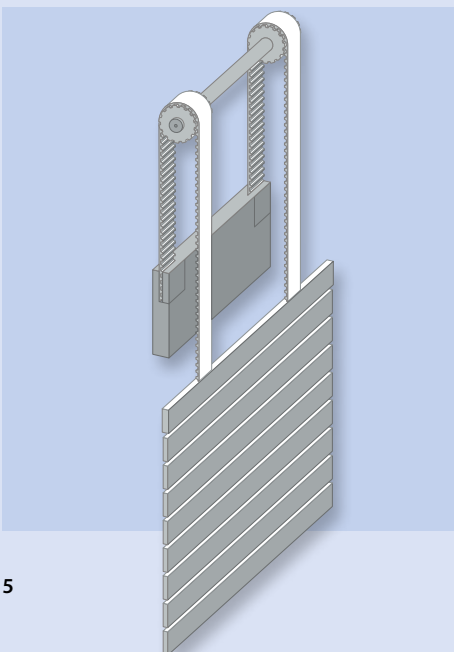

Standard product range

	Width [mm]	Z _{min} minimum number of teeth		Weight, approx. [kg/m ²]**	d _{min} approx. [mm]	F _{perm} approx. [N/mm width]**			
		Steel	Kevlar			Steel	open	welded endless	truly endless
T 5		6, 8, 10, 12, 16, 20, 25, 32, 50, 75, 100	10	16	2.4 - 2.0	25 - 30	~32 - ~38	~15 - ~19	~32 - -
T 5 L		10, 12, 16, 20, 25, 32, 50, 75, 100	12	19	2.8 - -	50 - -	- - -	- - -	~75 - -
T 10		10, 12, 16, 20, 25, 32, 40, 50, 75, 100	12	38	4.8 - 4.0	50 - 50	~85 - ~70	~42 - ~34	~77 - -
T 10 LE		16, 25, 32, 50, 75, 100	12	38	6.4 - -	90 - -	- - -	- - -	~141 - -
T 20		16, 20, 25, 32, 50, 75, 100	15	96	7.7 - 6.4	120 - 120	~134 - ~114	~67 - ~57	~159 - -
T 20 E		16, 20, 25, 32, 50, 75, 100	12	76	7.2 - -	90 - -	- - -	- - -	~140 - -
T 20 L		16, 20, 25, 32, 50, 75, 100	20	125	8.6 - -	140 - -	- - -	- - -	~289 - -
AT 5		10, 12, 16, 20, 25, 32, 50, 75, 100	12	18	3.0 - -	50 - -	~70 - -	~35 - -	~76 - -
AT 10		12, 16, 20, 25, 32, 50, 75, 100, 150	15	48	6.4 - -	90 - -	~155 - -	~77 - -	~152 - -
AT 10 E		10, 12, 16, 20, 25, 32, 50, 75, 100	14	45	6.4 - -	90 - -	~124 - -	~62 - -	~128 - -
AT 10 L		10, 12, 16, 20, 25, 32, 50, 75, 100	25	80	6.8 - -	120 - -	~284 - -	~75 - -	~286 - -



For detailed technical information visit www.forbo-siegling.com



* Width tolerance generally between ± 0.5 and ± 1.0 mm. You can find the exact figure for each belt width on the Internet.

** Median figures, rounded. You can find the exact figure for each belt width on the Internet.

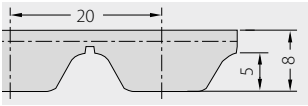
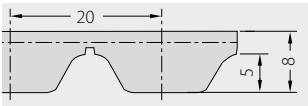
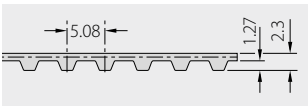
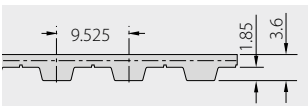
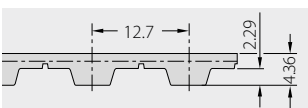
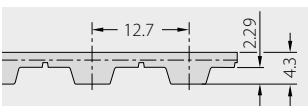
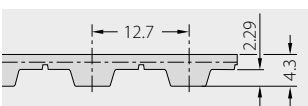
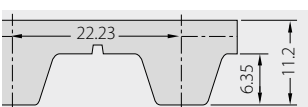
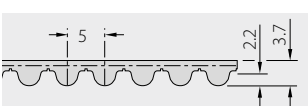
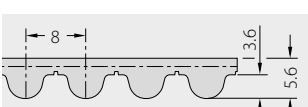
The figures stated are based on 20/50 ambient conditions.

	Width [mm]	Z _{min} minimum number of teeth		Weight, approx. [kg/m ²]**	d _{min} approx. [mm]	d _{min} approx. [mm] tensioning roller on toothed face			F _{perm} approx. [N/mm width]**		
		Steel	Kevlar			Steel	Kevlar	open	welded endless	truly endless	
AT 20		16, 25, 32, 50, 75, 100, 150	18	115	10	120	~273	~136	~290	-	-
AT 20 L		25, 32, 50, 75, 100, 150	22	140	11.1	170	~337	-	~320	-	-
XL		6,4, 7,9, 9,5, 12,7, 19,1, 25,4	10	16	-	-	-	-	-	-	-
L		9,5, 12,7, 19,1, 25,4, 38,1, 50,8, 76,2, 101,6	12	36	3.9	60	~86	~43	-	-	-
H		12,7, 19,1, 25,4, 38,1, 50,8, 76,2, 101,6	14	56	4.5	80	~85	~42	~79	-	-
HLE		12,7, 19,1, 25,4, 38,1, 50,8, 76,2, 101,6	12	49	5.2	90	-	-	~138	-	-
HL		12,7, 19,1, 25,4, 38,1, 50,8, 76,2, 101,6	15	61	5.5	90	-	-	~155	-	-
XH		25,4, 50,8, 76,2, 101,6	18	127	1.0	150	~132	~66	-	-	-
HTD 5 M		10, 12, 15, 20, 25, 32, 50, 75, 100	13	20	4.8	50	~72	~33	~76	-	-
HTD 8 M		10, 15, 20, 25, 30, 50, 85, 100	18	46	6.9	90	~147	~74	~155	-	-
HTD 8 ME		20, 25, 30, 50, 85, 100	16	41	6.5	90	-	-	~140	-	-

Continued on the next page

For detailed technical information visit www.forbo-siegling.com



MOVEMENT SYSTEMS

Standard product range

Width [mm]	Z _{min} minimum number of teeth		Weight, approx. [kg/m ²]**	d _{min} approx. [mm] tensiing roller on toothed face	F _{perm} approx. [N/mm width]**		
	d _{min} approx. [mm]	Steel			Steel	open	welded endless
HTD 14 M		25, 40, 55, 85, 115	11	120	~296	~148	~289
HTD 14 ML		55, 85, 115, 150	12	170	-	-	~347
HTD 14 MLL		55, 85, 115, 150	13.5	180	-	-	~447
RPP 8 M		15, 20, 25, 30, 50, 85	6.4	90	~153	~84	-

Standard wide timing belt range

Width min. [mm]*	Width max. [mm]*	Z _{min} minimum number of teeth	d _{min} approx. [mm]	Weight, approx. [kg/m ²]	d _{min} approx. [mm] tensiing roller on toothed face	endless welded belts	
						F _{perm} approx. [N/mm]**	Min. length made [mm]
WT 10		14	45	3.9	80	12.5	1100
WH		14	56.64	3.3	80	12.5	1104.9

For detailed technical information visit www.forbo-siegling.com



* Width tolerance generally between ± 0.5 and ± 1.0 mm. You can find the exact figure for each belt width on the Internet.

** Median figures, rounded. You can find the exact figure for each belt width on the Internet.

The figures stated are based on 20/50 ambient conditions.

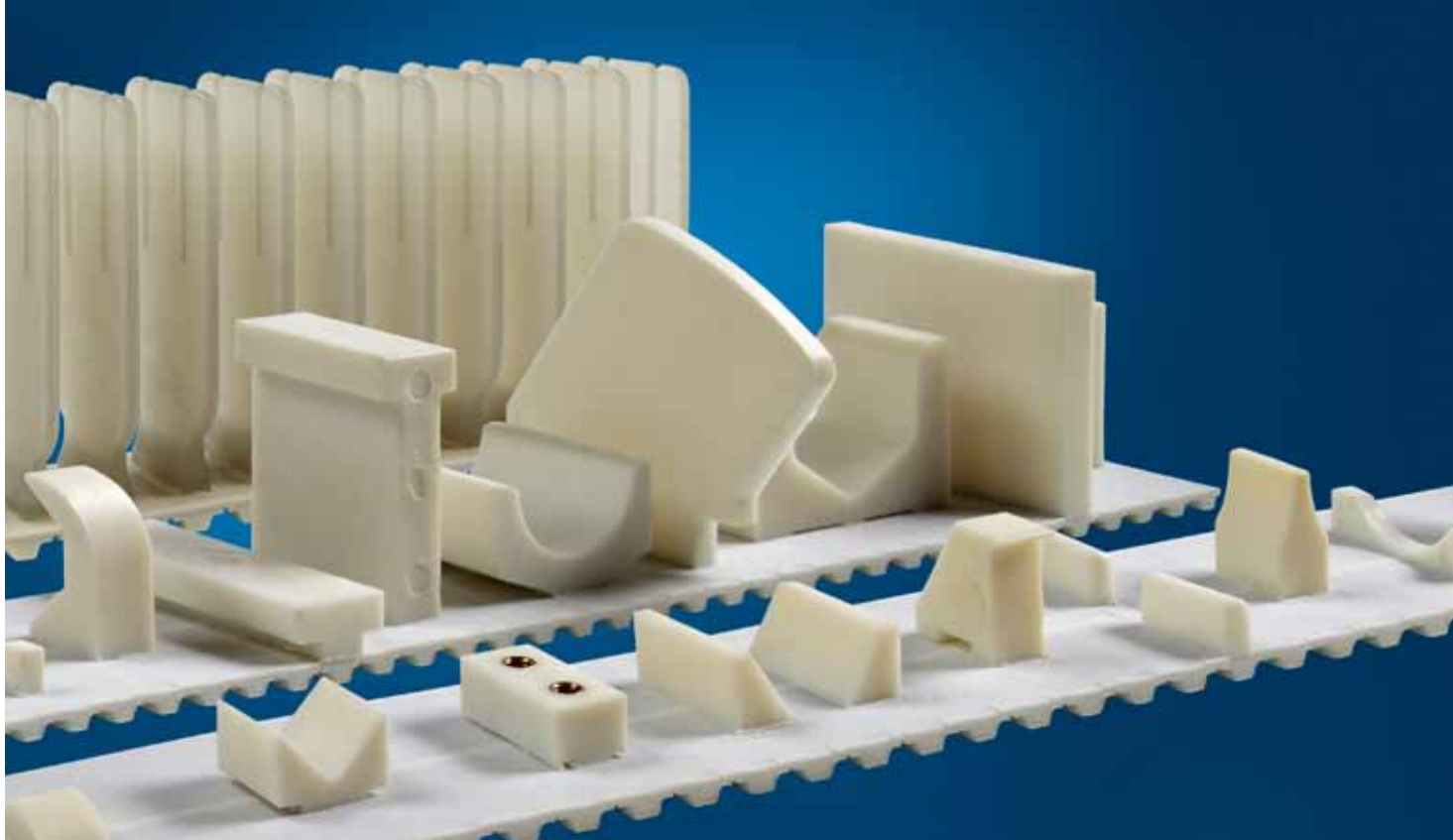

Cams and profiles

For conveying and many more specialised tasks in material handling (interval conveying, singling, positioning), cams and profiles pave the way for innovative design solutions. In addition to a number of standard cams from half-finished products, any special shapes can be made as injection moulded parts.

Welded cams

Cams are usually made of polyurethane – as are the timing belts themselves, ensuring the reliability of the weld between the cam and the reverse face of the timing belt. The welding of cams onto a timing belt affects its flexibility. The smallest possible cam thickness (t) should be selected. If possible, cams should be attached “opposite teeth”.

Screwed-on cams

Cams that are screwed on are particularly flexible to use. The original teeth on the belts are removed and replaced with brass teeth with threads. Brass teeth are available in T10/ AT10, T20, AT20 and XH tooth shapes. (Standard widths: 25/32/50; further widths on request).

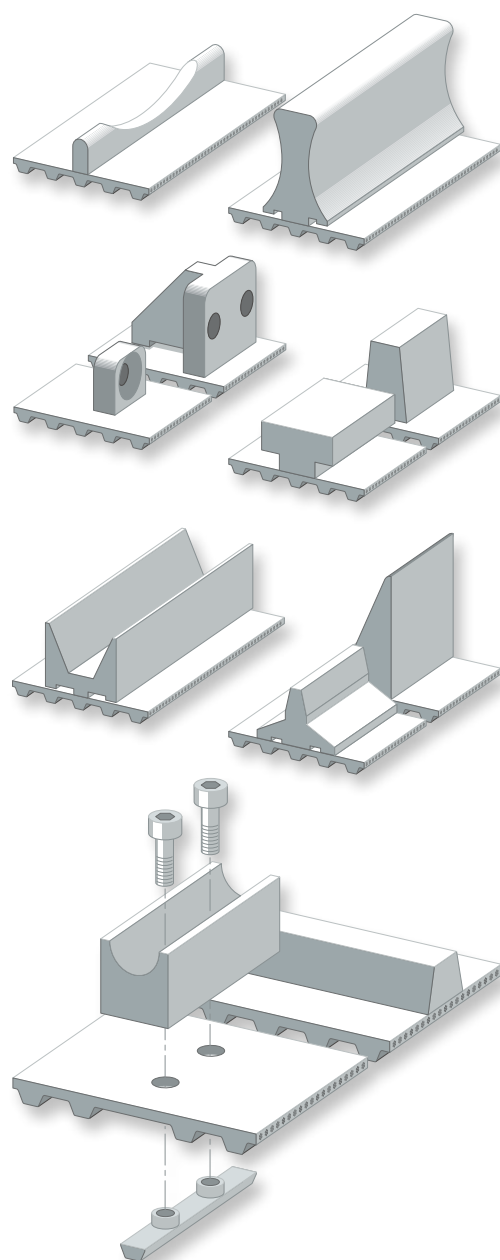

For detailed technical information visit www.forbo-siegling.com



Coatings

New Name (old Name)	Colour	Coating material	Hardness [Shore A]/Density	Coating thickness [mm]	d-factor*	Permissible operating temperature [°C]	Resistance**					
							to generic fats & oils	to acids, salts & bases	not to generic fats and oils	Food packaging	Vertical form, fill, seal belts for bagger machines	Pharmaceutical industry
1 Linatrilite	orange	Nitrile rubber (NBR)	55	3–12	25	-20/110	●					
2 Linatex	red	Natural Rubber	40	3–12	20	-40/70	●				●	
3 Linagard FG	white	Natural Rubber	40	3–12	20	-40/70	●				●	
4 PU 85 (U20)	transp.	Polyurethane (thermoplastic)	85	2–4	30	-20/80	●					
5 PU 60 (PU foil 60)	transp.	Polyurethane (thermoplastic)	60	2–4	25	-20/80	●					
6 PU 85/LG (U 20/LG; PU foil LG)	transp.	Polyurethane (thermoplastic)	85	2–4	30	-20/80	●					
7 NBR/NSTR (G/GSTR)	green	Nitrile rubber (NBR)	60	2.6	25	-20/100	●					
8 NBR/AR (G/AR; Supergrip)	black	Nitrile rubber (NBR)	60	3.5	25	-20/70	●					
9 PVC 65 (V/20; PVC)	white	PVC	65	1–2	25	-15/90		●		●		●
10 PVC 40 (PVC)	petrol	PVC	40	1–3	20	-15/90		●		●		●
11 PVC 65/FG (V/20/FG; FG)	white	PVC	65	3	30	-10/80		●		●		●
12 PVC 65/Pimple (Pimple top)	white	PVC	65	2.5	20	-10/80		●		●		●
13 PVC 65/Saw (Saw profile)	white	PVC	65	3	25	-10/80		●				●
14 PVC 50/AR (PVC/AR; Supergrip)	white	PVC	50	4.5	25	-15/80		●				
15 Porol (SZ/Porol)	black	Cellular rubber	165 kg/m ³	5–15	10	-40/70	●					
16 Sponge rubber (SO)	orange	Cellular rubber	250 kg/m ³	10–20	10	-40/70			●			
17 PU 55 (PU)	yellow	Polyurethane (thermoplastic)	55	2–10	20	-10/70	●					
18 Sylomer-G (Sylomer)	yellow	Polyurethane foam	160 kg/m ³	6–12	10	-30/70	●					
19 Sylomer-R (Sylomer)	blue	Polyurethane foam	220 kg/m ³	6–12	15	-30/70	●					
20 Sylomer-L (Sylomer)	green	Polyurethane foam	300 kg/m ³	6–12	15	-30/70	●					
21 Sylomer-M (Sylomer)	brown	Polyurethane foam	400 kg/m ³	6–12	20	-30/70	●					
22 Sylomer-P (Sylomer)	red	Polyurethane foam	500 kg/m ³	6–12	25	-30/70	●					
23 Vulcocell (Vulcocell VS40MH)	beige	Polyurethane foam	400 kg/m ³	2–10	20	-30/80	●					
24 NOVO-HC (Novo 12 HC)	black	Polyester felt	–	1.2	40	-10/120	●					
25 NOVO (Novo 25 NA)	white	Polyester felt	–	2.5	25	-10/120	●					●
26 Silicone	white	Silicone	35	1–10	50	-60/220	●			●		
27 Leather (Chrome leather)	grey	Chrome leather	–	2–3	25	-10/120	●					
28 PA fabric (Polyamide fabric)	green	Fabric, Polyamide	–	0.5	60	-20/50			●			
29 EPDM	black	Synthetic rubber (EPDM)	70	2–10	25	-40/100			●			
30 Correx	beige	Natural rubber	40	4–10	20	-20/80	●					
31 NBR/FSTR (Elastomer)	green	Nitrile rubber (NBR)	65	1–2	25	-20/70			●			
32 PTFE (Teflon)	grey	Polytetrafluoroethylene (PTFE)	–	0.3	300	-200/260	●			●		●
33 Viton	black	Fluoric rubber (FKM mix)	70	1–5	25	-10/275	●					
34 PU 85/FSTR (UU 20U NA FSTR/FSTR)	white	Polyurethane (thermoplastic)	85	1	10	-20/60	●			●		●
35 PU 85/NSTR (UU 20U)	black	Polyurethane (thermoplastic)	85	1	10	-20/60	●					
36 PU 85/NP (UU 20U NA FSTR/NP)	blue	Polyurethane (thermoplastic)	85	1.4	10	-20/60	●			●		●
37 R 60 (UR 40U)	blue	Thermoplastic high grip elastomer	60	1.3	20	-20/60	●			●		●
38 PU 85-HC+ (UU 20U-HC+ FSTR/FSTR)	black	Polyurethane (thermoplastic)	85	1.1	10	-20/60	●					

Various coatings can be applied to all standard Siegling Proposition types.

On the toothed and/or reverse face, coverings of polyamid fabric reduce the drag. This facilitates the intermeshing of the teeth, in turn reducing the noise.

Other coverings and coatings for the reverse face, varying in material and texture considerably,

- increase the drag, thereby improving the grip properties (pick-off belts, inclined conveyors)
- conform to FDA regulations (processing of food)
- protect the surface of sensitive goods (glass, furniture)
- are largely unaffected by rough goods or goods with sharp edges thanks to their tenacity (sheet metal, wood).

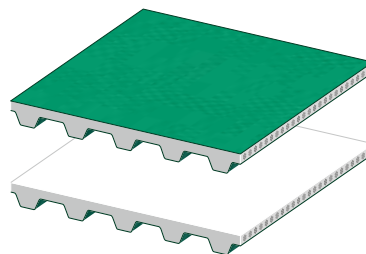

PAZ/PAR: polyamide fabric (on both faces)

PAZ: polyamide fabric (toothed face)

Characteristic/application:

low drag, protects against wear, reduces noise

For the types PAZ and PAZ/PAR the polyamide fabric is applied during the production of the timing belt. Therefore their sizes correspond to those of the standard types.

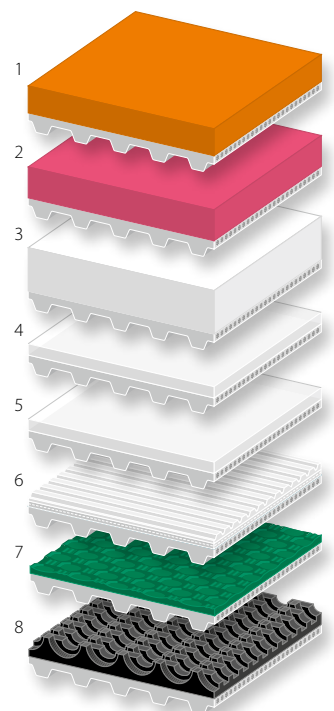

Applications

Properties

	Bottle inspection lines	Glass conveying	Solar-panel industry	Wood conveying	Paper/Cardboard conveying	Metal parts conveying	Feeder & haul-off belts	General conveying	Conveying of sensitive goods	Conveying of abrasive goods	Conveying of hot and sticky goods	Good release properties	Temperature range limited by PU timing belt material	
				●			●						●	High elasticity. Constantly high friction.
				●	●								●	Abrasion resistant even in wet conditions. High elasticity. Constantly high friction.
					●								●	Abrasion resistant even in wet conditions. High elasticity. Constantly high friction.
		●			●	●							●	High chemical resistance. Excellent cut and wear resistance.
		●			●								●	High chemical resistance in general.
		●			●			●					●	High chemical and abrasion resistance in general.
				●	●	●				●			●	High abrasion and cut resistance. Fuel and oil resistant.
					●			●						Supergrip profile for incline conveying. Fuel and oil resistant.
					●			●						Smooth surface, good cleanability. Food grade.
														Smooth surface, high friction.
		●												Food grade. Special herringbone profile.
				●				●						Special pimple top profile.
					●			●						Special saw tooth profile.
					●									Supergrip profile for incline conveying.
					●				●					Excellent cushioning and confirming to products. Cell structure closed.
					●				●					Excellent cushioning and confirming to products. Cell structure open.
	●				●		●						●	High chemical resistance in general.
	●	●			●									Excellent cushioning and confirming to products. Cell structure open.
					●									Excellent cushioning and confirming to products. Cell structure open.
					●				●					Excellent cushioning and confirming to products. Cell structure open.
					●				●					Good cushioning and confirming to products. Cell structure open.
					●				●					Cell structure open.
					●				●					Excellent cushioning and confirming to products. Cell structure open.
		●			●			●					●	Non-marking. High conductive coating. Low friction, accumulation possible.
		●			●			●					●	Non-marking. Low friction, accumulation possible.
					●						●		●	Excellent release properties and cleanability. High friction.
					●	●			●					Highly resistant to oil and fuel. Excellent cut and wear resistance.
		●			●			●						Suitable for gentle conveying of sensitive goods, accumulation possible.
					●									Low friction, accumulation possible. Good abrasion resistance.
					●								●	Excellent abrasion and cut resistance.
					●			●						Natural rubber. High friction and abrasion resistant.
					●									Excellent cut and wear resistance.
					●						●		●	Excellent release properties and cleanability. Low friction, accumulation possible.
					●								●	Excellent chemical and heat resistance.
					●			●					●	High chemical resistance. Excellent cut and wear resistance.
					●			●					●	High chemical resistance. Excellent cut and wear resistance.
				●	●			●					●	High chemical resistance. Excellent cut and wear resistance.
				●	●			●					●	High chemical resistance. Excellent cut and wear resistance.
			●	●	●			●					●	High chemical resistance. Excellent cut and wear resistance.

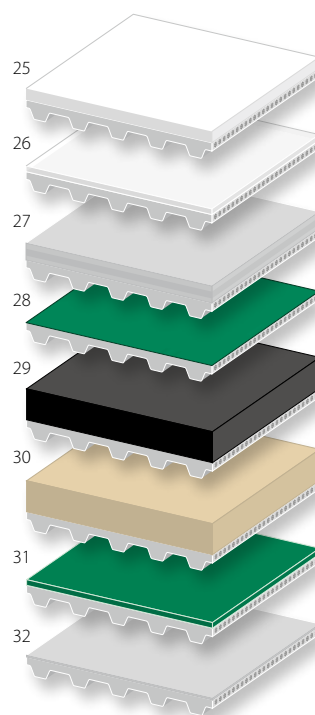
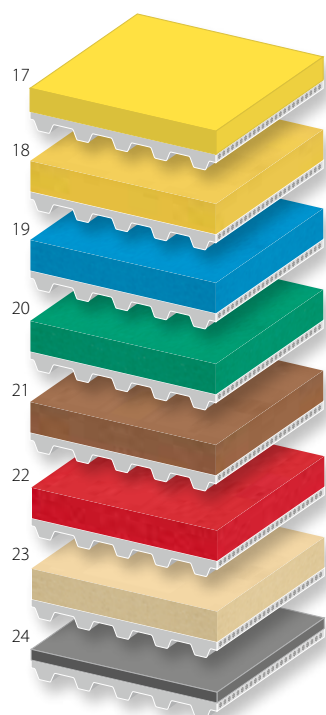
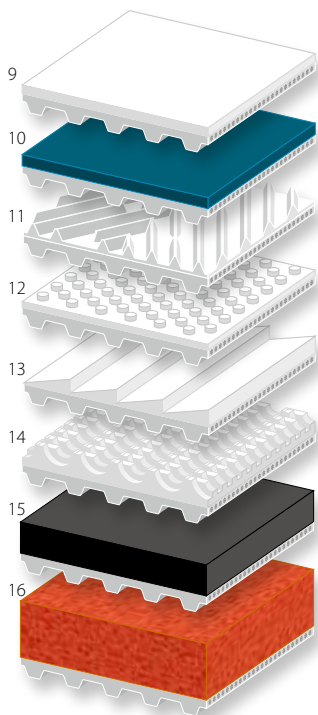

* Factor x belt thickness = smallest diameter (approx. value)
** If uncertain, please contact Forbo Siegling

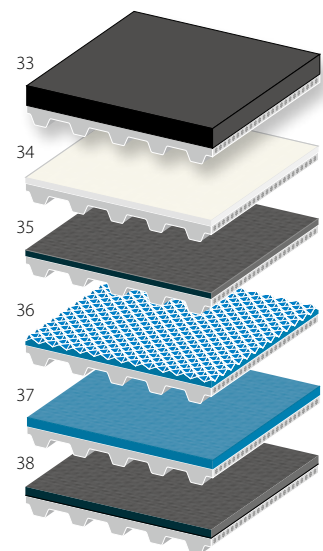

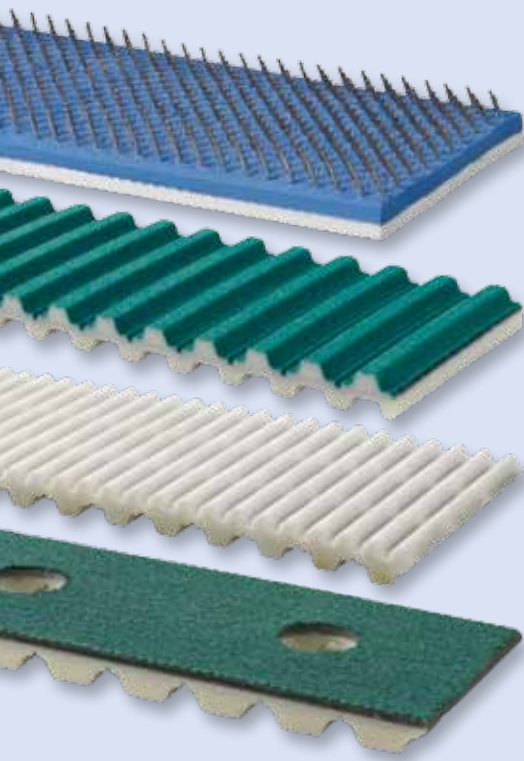

Customised products

By modifying timing belts with and without coatings or coverings afterwards, it is possible to tailor them exactly to meet the needs of individual applications in materials handling. Because of the wide array of possibilities and combinations, we can show you here just a very small selection. Please contact your Forbo Siegling partner regarding any specific requirements you may have.

Mechanical processing

Almost any shape can be milled, ground or punch-cut into timing belts and coatings or coverings with very narrow tolerances. CNC-powered machines and water jets are used.

Special coatings and coverings

It is possible to apply an extra covering of PA fabric afterwards – also to sections which have been milled – to improve the low grip properties.

Special colours

Timing belts (as well as cams) can be produced in special colours.

Truly endless belts

Information about truly endless belts (polyurethane and neoprene) is available on request.

You can find more detailed information here:
www.forbo-siegling.com



Timing belts with longitudinal tracking profiles

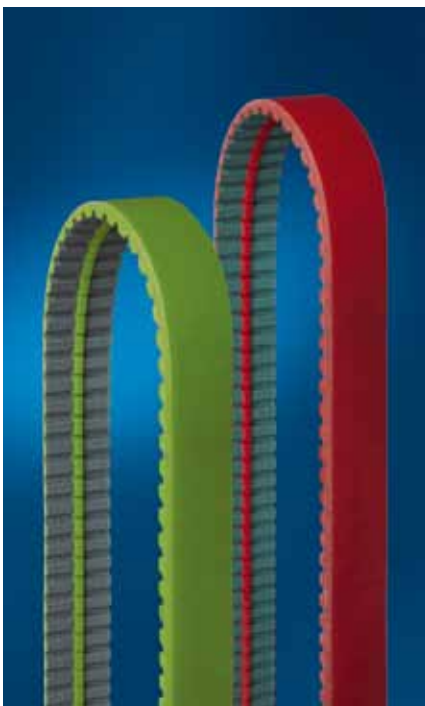

The wedge profiles mounted on the timing belts ensure that the belts track perfectly straight over the entire length, even where lateral forces are a factor. Flanged pulleys are not required. All timing belt types can be equipped with various wedge profiles.

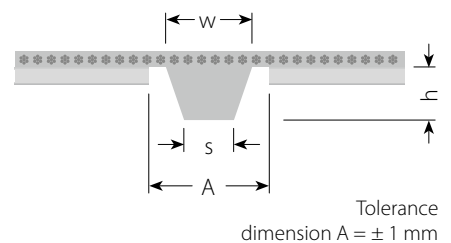

Longitudinal tracking profiles

Type	Material	Colour	w x h x s [mm]	Hardness [Shore A]	Groove with A [mm]	d _{min} [mm]
K 6-U65	Urethane	transparent	6 x 4 x 4	65	7	40
K 10-U65	Urethane	transparent	10 x 6 x 6	65	11	70
K 13-U65	Urethane	transparent	13 x 8 x 7.5	65	14	100
K 15-U65	Urethane	transparent	15 x 8 x 9.5	65	16	100
K 17-U65	Urethane	transparent	17 x 11 x 9.5	65	18	100



Powerbelt

Technical information

Material:	polyurethane elastomer
Hardness:	92° Shore A
Tension member:	Steel (standard) or Kevlar (on request)
Colour:	black
Permissible operating temperature:	-5/+80 °C
Thickness:	2 mm (standard) other thicknesses on request

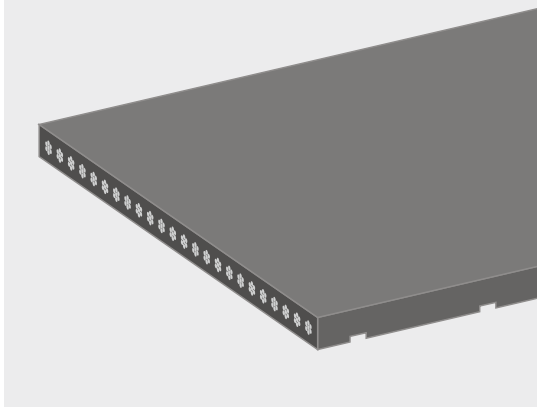

For the transmission of large tensile forces, the Forbo Siegling Powerbelt is an alternative to cables, chains and fabric belts.

Forbo Siegling Powerbelt was developed especially for use in sports and fitness equipment, roll-up doors and venetian blinds. It is available only as open material.

Data sheet available on request.

forbo

MOVEMENT SYSTEMS

Accessories

Toothed pulleys for timing belts

For the service life of the timing belt and for smooth operations, it is vital that the toothed pulley be matched correctly to the timing belt.

For all timing belts in its product range, Forbo Siegling carries the corresponding toothed pulley.



- Standard design with boring
- Special methods of attachment on request
- O pulleys and SE pulleys available on request
- Can be fabricated from drawing

Standard material for general applications is aluminium. For higher loads, steel pulleys are recommended. Toothed pulleys are available on request.

You can find more detailed information here:
www.forbo-siegling.com

Clamping plates

Clamping plates for fastening open material are available for all timing belt types and in all standard sizes.



Endless splices

Open Siegling Proposition timing belts are made endless with a meander or Z-splice. Although with this splice approximately 50% of the tensile strength of truly endless timing belts is achieved, such belts should not be used as power transmission belts.

Welded splices

Timing belts prepared for the meander splice can be hot-pressed endless quickly and easily on-site with our heating devices. This process makes time-consuming fitting work on the machine unnecessary.

The SMX-HP 150/120-PP and SMX-HP 150/60-PP heating presses can be used (with the corresponding splice guide) for all timing belts of all widths.

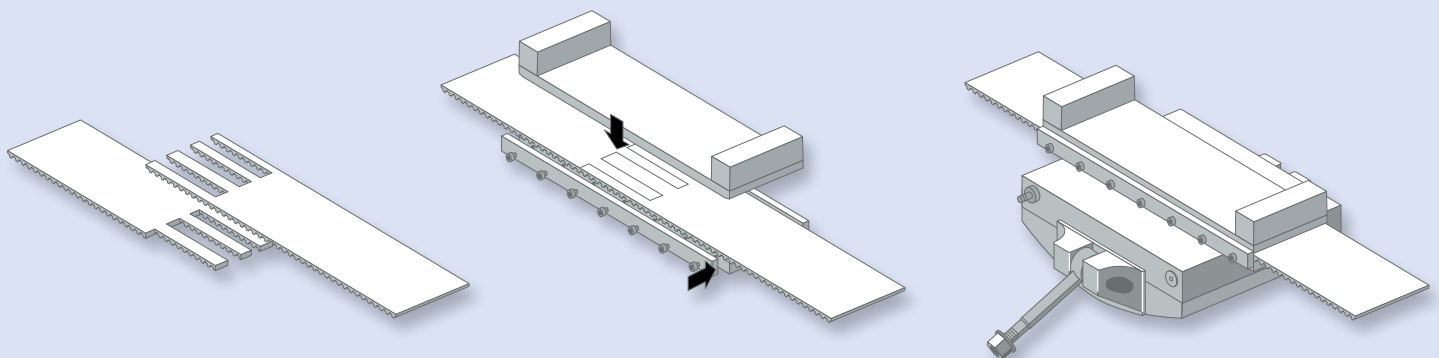



Mechanical fasteners

Specially prepared timing belts (teeth with drilled holes) can be made endless using pins. This procedure is ideal when low downtimes are required when exchanging belts or carrying out maintenance.

Mechanical fasteners are available as a standard for T5, T10, T20, AT5, AT10 and AT20. Other types on request.

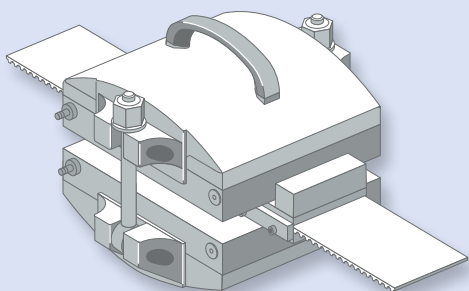
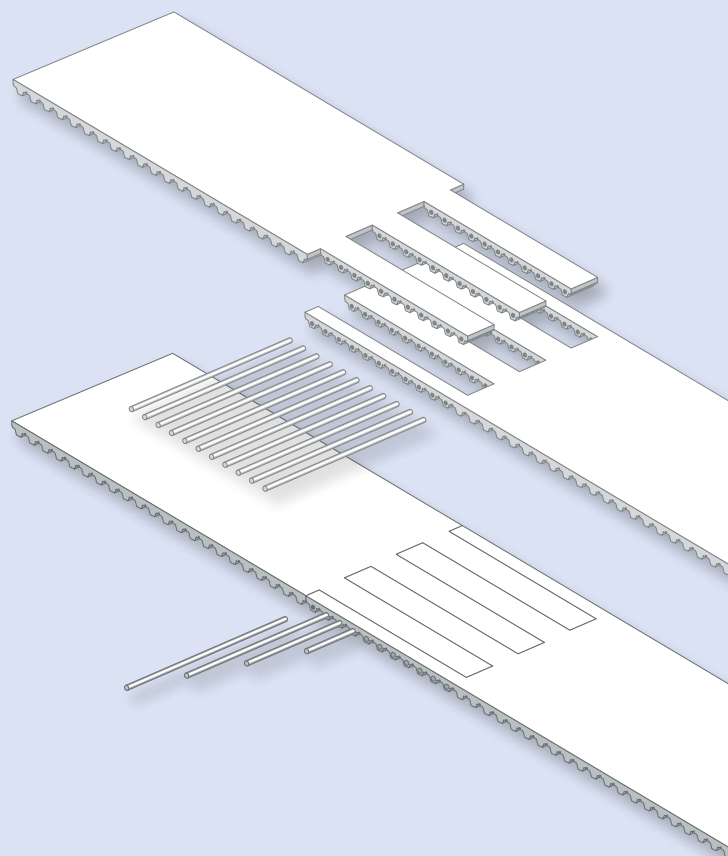

Siegling – total belting solutions

Committed staff, quality oriented organization and production processes ensure the constantly high standards of our products and services.

Forbo Movement Systems complies with total quality management principles. Our quality management system has ISO 9001 certification at all production and fabrication sites. What's more, many sites have ISO 14001 environmental management certification.



Our service – anytime, anywhere

Forbo Movement Systems employs around 2,500 people in its group of companies. Our products are manufactured in ten production facilities across the world. You can find companies and agencies with warehouses and workshops in over 80 countries. Service points are located in more than 300 places worldwide.