

Bonfiglioli **Riduttori**

C series

Helical gear units

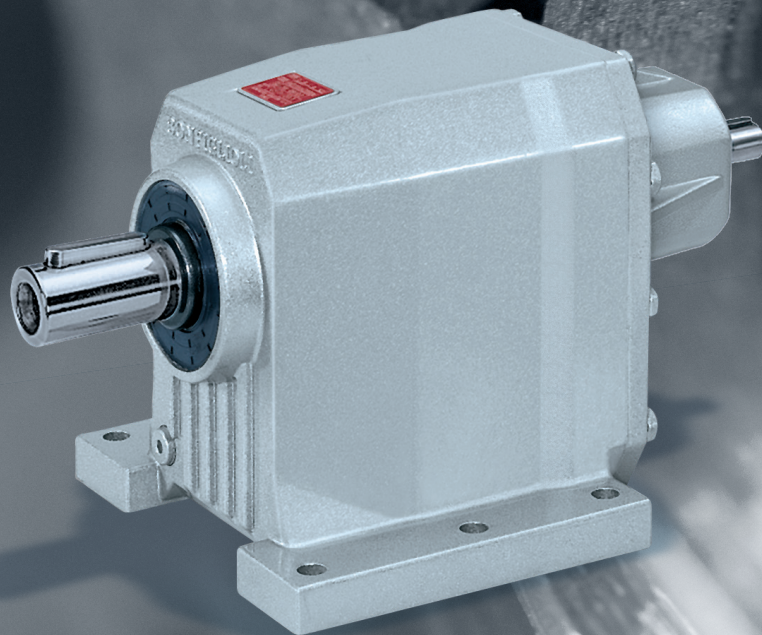

PRODUCT



SUMMARY

Chapter	Description	Page
1	GENERAL INFORMATION	2
1.1	Symbols and units of measure	2
1.2	Introduction to the ATEX directives	4
1.2.1	Explosive atmosphere	4
1.2.2	European harmonised ATEX standards	4
1.2.3	Levels of protection for the various categories of equipment	5
1.2.4	Definition of groups (EN 1127-1)	5
1.2.5	Declaration of conformity	6
1.3	Use, installation and maintenance	6
1.4	Selecting the type of equipment	7
1.4.1	Selection procedure	7
1.4.2	Selecting a gear unit with IEC motor fitting	7
1.4.3	Speed reducer with solid input shaft	8
1.4.4	Post-selection checks	8
1.4.5	Operating conditions for ATEX-specified equipment	8
1.4.6	Service factor	9
2	C SERIES HELICAL IN-LINE UNITS FOR POTENTIALLY EXPLOSIVE ENVIRONMENTS	10
2.1	Construction of ATEX-specified equipment	10
2.2	Versions	11
2.3	Ordering numbers	12
2.4	Mounting position	13
2.5	Lubrication	14
2.6	Admissible overhung loads	15
2.6.1	Radial loads	15
2.6.2	Thrust loads	16
2.7	Gearbox rating charts	17
2.8	Motor availability	25
2.8.1	Geometrical compatibility	25
2.8.2	Maximum installable power	26
2.9	Moment of inertia	27
2.10	Dimensions	35

Revisions

Refer to page 48 for the catalogue revision index. Visit www.bonfiglioli.com to search for catalogues with up-to-date revisions.



1 GENERAL INFORMATION

1.1 SYMBOLS AND UNITS OF MEASURE

- An** [N] The **admissible thrust load** represents the force which can be applied axially to the gear unit's shaft, along with the rated radial load.
- f_s** - The **service factor** is a coefficient representing the severity of the duty for the operating cycle.
- f_{TP}** - The **adjusting factor** takes into account the influence of the ambient temperature in calculating the computational torque. This factor is relevant for worm gear units.
- i** - The **gear ratio** is expressed as the relationship of the input shaft speed to the output shaft speed.

$$i = \frac{n_1}{n_2}$$

- I** - The **intermittence** is defined as follows:

$$I = \frac{t_f}{t_f + t_r} \cdot 100$$

J_c [Kgm²] **Moment of inertia of the driven load.**

J_m [Kgm²] **Moment of inertia of the motor.**

J_R [Kgm²] **Moment of inertia of the gear unit.**

- K** - The load **acceleration factor** is used to calculate the service factor, and is defined as follows:

$$K = \frac{J_c}{J_m}$$

- K_R** - The **transmission factor** is a computational parameter, proportional to the tension generated by an external transmission keyed to the gear unit shaft.

M₂ [Nm] **Net output torque**

Mn₂ [Nm] The **rated torque** at the output shaft.
The catalogue value is calculated for a service factor f_s = 1.

Mr₂ [Nm] The application's **required torque** .
This should always be less than or equal to the gear unit's rated torque Mn₂.

Mc₂ [Nm] **Computational torque.** This is a virtual parameter used to select the gear unit, by means of the equation:

$$M_{c2} = M_{r2} \cdot f_s$$

n [min⁻¹] **Shaft speed.**

Pn₁ [kW] **Rated power** at the input shaft, calculated for a service factor f_s = 1.



P_R [kW] The application's **required power** .

R_C [N] The **computational radial load** is generated by an external transmission and, for the input and output shafts respectively, can be calculated from the following equations:

$$R_{c1}[N] = \frac{2000 \cdot M_1[Nm] \cdot K_r}{d [mm]} \quad ; \quad R_{c2}[N] = \frac{2000 \cdot M_2[Nm] \cdot K_r}{d [mm]}$$

R_N [N] The **admissible radial load** should always be more than or equal to the computational radial load. The point value is given in the catalogue for each unit's gear frame size and transmission ratio, and refers to the shaft's centre line.

S - The **safety factor** is defined as follows:

$$S = \frac{Mn_2}{M_2} = \frac{Pn_1}{P_1}$$

t_a [°C] **Ambient temperature.**

t_f [min] The **operating time** is the total duration of the work cycle phases.

t_r [min] The **rest time** is the interval of no work between two phases.

Z_r - **Number** of starts per hour.

η_d - The **dynamic efficiency** is expressed as the ratio between the power measured at the output shaft and that applied to the input shaft:

$$\eta_d = \frac{P_2}{P_1} \cdot 100 \quad [\%]$$

$[]_1$ This value refers to the input shaft.

$[]_2$ This value refers to the output shaft.



Danger. May cause slight injury to persons.



1.2 INTRODUCTION TO THE ATEX DIRECTIVES

1.2.1 EXPLOSIVE ATMOSPHERE

Under the provisions of Directive 2014/34/EU, an explosive atmosphere is defined as a mixture:

- a. of **flammable substances**, in the form of gases, vapours, mists or dusts;
- b. with **air**;
- c. under **atmospheric conditions**;
- d. in which, after ignition, the combustion spreads to the entire unburned mixture (it has to be noted that sometimes, mainly with dust, not always the whole quantity of the combustible material is consumed by the combustion).

An atmosphere which may potentially be transformed into an explosive atmosphere due to operating and/or ambient conditions is defined as a **potentially explosive atmosphere**. The products governed by Directive 2014/34/EU are intended for use only in a potentially explosive atmosphere defined in this way.

1.2.2 EUROPEAN HARMONISED ATEX STANDARDS

Directive ATEX 2014/34/EU stipulates the minimum safety requirements for products intended for use in explosion risk areas within the member countries of the European Union. The directive also assigns such equipment to **categories**, which are defined by the directive itself.

The following table describes the **zones** into which the user of a plant, in which an explosive atmosphere may occur, is required to divide the equipment application areas.

Zones		Formation frequency of a potentially explosive atmosphere	Type of danger
Gaseous atmosphere G	Dusty atmosphere D		
0	20	Present continuously or for long periods	Permanent
1	21	Likely to occur in normal operation occasionally	Potential
2	22	Not likely to occur in normal operation but if it does occur will persist for short period only	Minimal

BONFIGLIOLI RIDUTTORI gear units selected in this catalogue are suitable for installation in zones 1, 21, 2 and 22, as highlighted in grey in the above table.

As from 20 April 2016 the ATEX directives 2014/34/EU come into force throughout the entire European Union, and replace existing conflicting national and European laws on explosive atmospheres and the previous directive 94/9/EC. It should be emphasised that, for the first time, the directives also govern mechanical, hydraulic and pneumatic equipment, and not only electrical equipment as has been the case so far.

With regard to the Machinery Directive 2006/42/EC it should be noted that directive 2014/34/EU is a set of extremely specific requirements dedicated to the dangers deriving from potentially explosive atmospheres, whereas the Machinery Directive contains only very general explosion safety requirements (Annex I).

Consequently, as regards protection against explosion in potentially explosive atmospheres, Directive 2014/34/EU takes precedence over the Machinery Directive. The requirements of the Machinery Directive apply to all other risks regarding machinery.

1.2.3 LEVELS OF PROTECTION FOR THE VARIOUS CATEGORIES OF EQUIPMENT

The various categories of equipment must be able to operate in conformity with the Manufacturer's operational specifications, at certain defined levels of protection.

Protection level	Category		Type of protection	Operating conditions
	Group I	Group II		
Very high	M1		Two independent means of protection or safety capable of operating even when two independent faults occur	The equipment remains powered and operational even in the presence of an explosive atmosphere
Very high		1	Two independent means of protection or safety capable of operating even when two independent faults occur	The equipment remains powered and operational in zones 0, 1, 2 (G) and/or zones 20, 21, 22 (D)
High	M2		Protection suitable for normal operation and heavy duty conditions	Power to the equipment is shut off in the presence of a potentially explosive atmosphere
High		2	Protection suitable for normal operation and frequent faults or equipment in which malfunction is normal.	The equipment remains powered and operational in zones 1, 2 (G) and/or zones 21, 22 (D)
Normal		3	Protection suitable for normal operation	The equipment remains powered and operational in zones 2 (G) and/or 22 (D)

1.2.4 DEFINITION OF GROUPS (EN 1127-1)

Group I Applies to equipment intended for use underground in parts of mines and those parts of surface installations of such mines, liable to be endangered by firedamp and/or combustible dust.

Group II Applies to equipment intended for use in other places liable to be endangered by explosive atmospheres.

BONFIGLIOLI RIDUTTORI products may not therefore be installed in mines, classified in **Group I** and in **Group II**, category 1.

To summarise, the classification of equipment into groups, categories and zones is illustrated in the table below, whereby the availability of BONFIGLIOLI RIDUTTORI products is highlighted in grey.

Group	I		II					
	mines, firedamp		other potentially explosive areas (gas, dust)					
Category	M1	M2	1		2		3	
Atmosphere ⁽¹⁾			G	D	G	D	G	D
Zone			0	20	1	21	2	22
Type of protection gear unit					c, k	c, k	c, k	c, k
Type of protection motor					d, e	IP6X + temp.max	n(A)	IP5X o IP6X + temp. max

⁽¹⁾ G = gas D = dust

This catalogue describes BONFIGLIOLI RIDUTTORI gear units, intended for use in potentially explosive atmospheres, with limitation to categories 2 and 3.

The products described herein conform to the minimum safety requirements of European Directive 2014/34/EU, which is part of the directives known as ATEX (ATmosphères EXplosibles).



1.2.5 DECLARATION OF CONFORMITY

The Declaration of Conformity, is the document which attests to the conformity of the product to Directive 2014/34/EU. The validity of the Declaration is bound to observance of the instructions given in the User, Installation and Service Manual for safe use of the product throughout its service life.

This can be downloaded from www.bonfiglioli.com where the manual is available in PDF format in a number of languages.

The instructions regarding ambient conditions are of particular importance inasmuch as failure to observe them during operation of the product renders the certificate null and void.

In case of doubt regarding the validity of the certificate of conformity, contact the BONFIGLIOLI RIDUTTORI technical department.

1.3 USE, INSTALLATION AND MAINTENANCE

The instructions for safe storage, handling and use of the product are given in the unit's User, Installation and Service Manual.



This can be downloaded from www.bonfiglioli.com where the manual is available in PDF format in a number of languages.

This document must be kept in a suitable place, in the vicinity of the installed gear unit, as a reference for all persons authorised to work with or on the product throughout its service life.

The Manufacturer reserves the right to modify, supplement or improve the Manual, in the interests of the User.

1.4 SELECTING THE TYPE OF EQUIPMENT

1.4.1 SELECTION PROCEDURE:

Determine the application service factor f_s in relation to the type of load (K factor), number of starts per hour Z_r and hours of operation per day.

Now determine the power required at the motor shaft:

$$P_{r1} = \frac{M_{r2} \cdot n_2}{9550 \cdot \eta_d} \quad [\text{kW}]$$

The efficiency value « η_d » can be determined as follows (approximately):

	η_d
1	0.98
2	0.96
3	0.93
4	0.90

The selection procedure now depends on the type of gear unit, as follows:

- gear unit equipped with IEC motor fitting
- gear unit equipped with solid input shaft.

Proceed as follows:

1.4.2 SELECTING A GEAR UNIT WITH IEC MOTOR FITTING

- Determine service factor f_s as formerly specified.
- With reference to the rating charts, identify the gear unit which, for the required speed n_2 , provides a rated power P_{n1} such that:

$$P_{n1} \geq P_{r1} \times f_s$$

- Select an electric motor rated:

$$P_1 \geq P_{r1}$$

- Finally, check that the motor/gear unit combination generates a safety factor equal to or greater than the service factor for the application in question, in other words:

$$S = \frac{P_{n1}}{P_1} \geq f_s$$

- If the selected gear unit is of type C122, C222 or C322 with ratio $i > 40$, operating with a number of hourly starts $Z > 30$, correct the service factor taken from the graph by a factor of 1.2.

Finally, check that the recalculated service factor f_s still satisfies the condition $S \geq f_s$.



1.4.3 SELECTING A SPEED REDUCER WITH SOLID INPUT SHAFT

- Calculate the value of the computational torque:

$$M_{c2} = M_{r2} \times f_s \times f_{tp}$$

Helical gear units C, A, F, S	f_{tp}			
	Worm gear units VF, W			
$f_{tp} = 1$	Type of load	Ambient temperature [°C]		
		20°	30°	40°
	K1 uniform load	1.00	1.00	1.06
	K2 moderate shock load	1.00	1.02	1.12
	K3 heavy shock load	1.00	1.04	1.17

- for the speed n_2 closest to that required, select the gear unit with a rated torque M_{n2} equal to or greater than the computational torque M_{c2} , in other words:

$$M_{n2} \geq M_{c2}$$

1.4.4 POST-SELECTION CHECKS

Once the gear unit or the gear unit with IEC motor fitting has been selected, we recommend checking the selection as follows:

- Momentary peak torque**
 The momentary peak torque is of the order of 200% of the rated torque M_{n2} . Check that the point value of the peak torque satisfies this condition and equip the installation with a torque limiter if necessary.
- Radial load**
 The catalogue gives the values of the maximum admissible radial load for both the input shaft « R_{n1} » and the output shaft « R_{n2} ». These values refer to a load applied at the shafts' centre lines and must always be greater than the actually applied load. See paragraph: Radial loads.
- Thrust load**
 Check that the thrust component of the load does not exceed the maximum admissible value as given in the paragraph: Thrust loads.

1.4.5 OPERATING CONDITIONS FOR ATEX-SPECIFIED EQUIPMENT

- Ambient temperature $-20^{\circ}\text{C} < t < +40^{\circ}\text{C}$.
- The gear unit must be installed in the mounting position specified in the order and given on the nameplate. Any deviation from this requirement must be approved in advance by BONFIGLIOLI RIDUTTORI.
- Do not under any circumstances install the gear unit with its shaft in an inclined orientation, unless previously authorised to do so by the BONFIGLIOLI RIDUTTORI Technical Service Department.
- The speed of the motor mounted to the gear unit must not exceed $n = 1500 \text{ min}^{-1}$.
- Should the gearbox be connected to an inverter driven motor the latter must be explicitly suitable for the purpose and used in full compliance with the instructions set forth by the manufacturer. Under no circumstances the setting of the inverter shall allow the motor to exceed the maximum speed permitted (1500 min^{-1}) or overload the gearbox itself.
- All the instructions in the User Manual (www.bonfiglioli.com) regarding installation, use and routine maintenance of the unit must be followed in full.

1.4.6 SERVICE FACTOR - [f_s]

This factor is the numeric value describing reducer service duty. It takes into consideration, with unavoidable approximation, daily operating conditions, load variations and overloads connected with reducer application.

In the graph below, after selecting proper “daily working hours” column, the service factor is given by intersecting the number of starts per hour and one of the K1, K2 or K3 curves.

K_ curves are linked with the service nature (approximately: uniform, medium and heavy) through the acceleration factor of masses K, connected to the ratio between driven masses and motor inertia values.

Regardless of the value given for the service factor, we would like to remind that in some applications, which for example involve lifting of parts, failure of the reducer may expose the operators to the risk of injuries.

If in doubt, please contact our Technical Service Department.

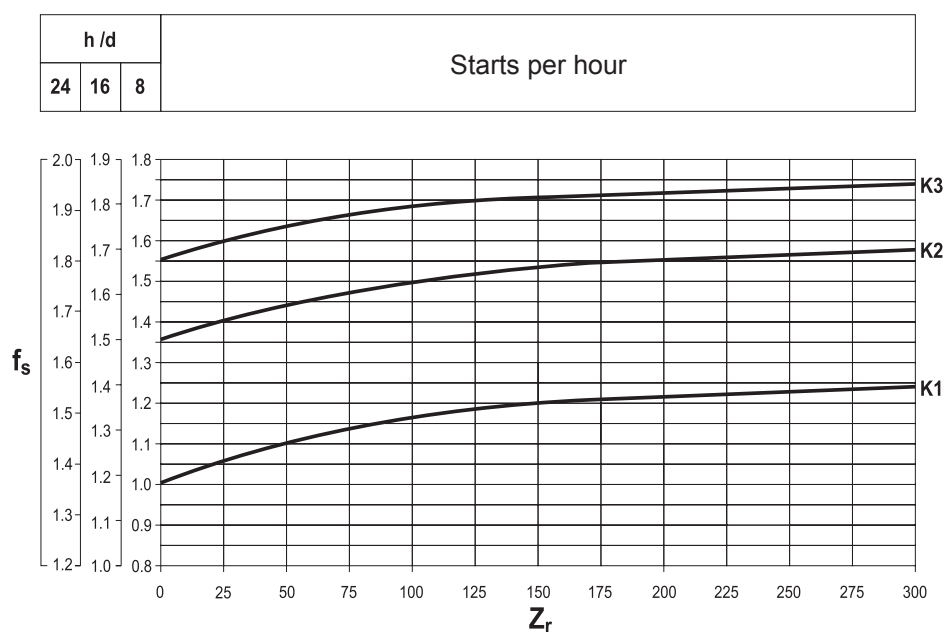

Acceleration factor of masses - [K]

This parameter serves for selecting the right curve for the type of load. The value is given by the following ratio:

$$K = \frac{J_c}{J_m}$$

where:

J_c moment of inertia of driven masses referred to motor shaft

J_m moment of inertia of motor



2 C SERIES HELICAL IN-LINE UNITS FOR POTENTIALLY EXPLOSIVE ENVIRONMENTS

2.1 CONSTRUCTION OF ATEX-SPECIFIED EQUIPMENT

- Equipped with service plugs for periodic lubricant level checks.
- Factory-charged with lubricant, depending on the mounting position specified in the order.
- Fluoro elastomer seal rings as standard.
- Double seal rings on the output shaft.
- No plastic component parts.
- Nameplate indication of the product category and type of protection.

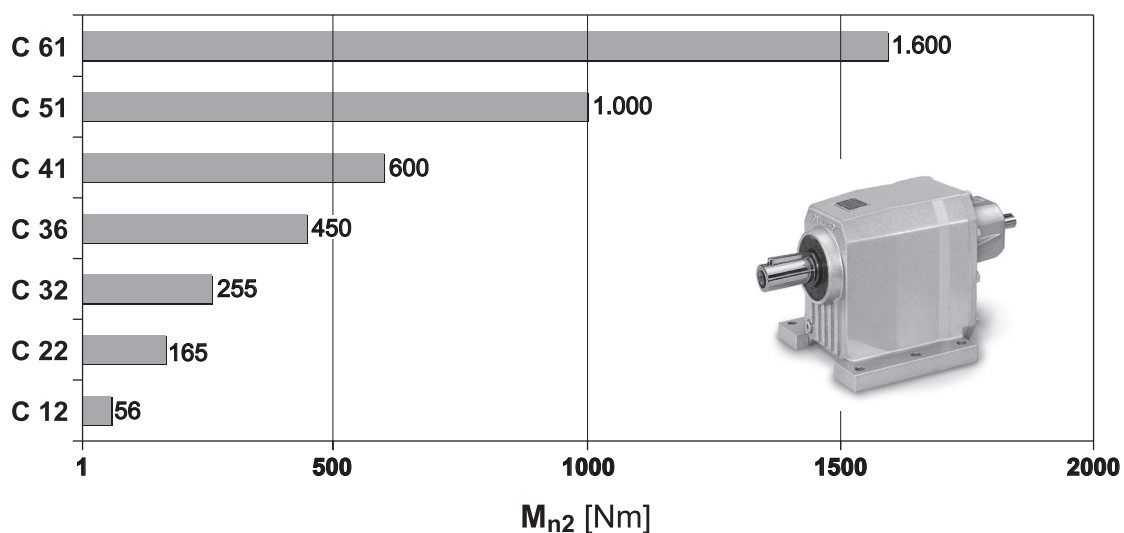

2.2 VERSIONS

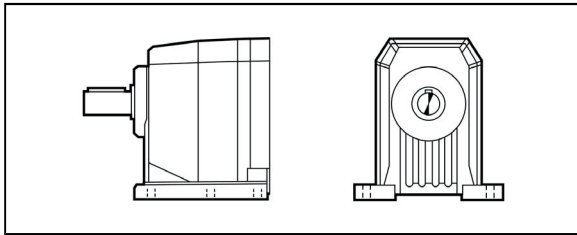

P

Foot mounted

C1/ ...C61

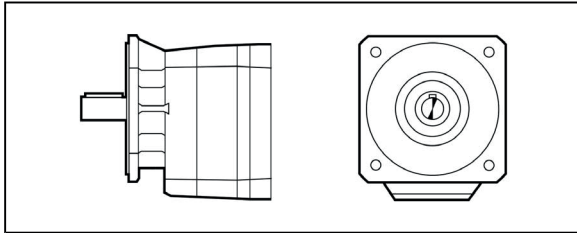

F

Flange mounted

C1/ ...C3/

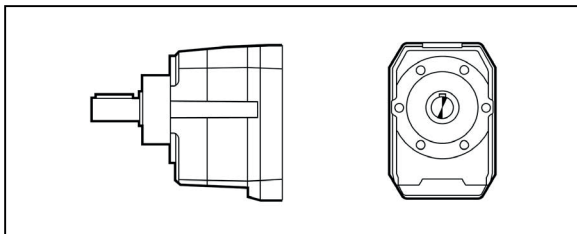

U

UNIBOX- universal housing

C1/ ...C61

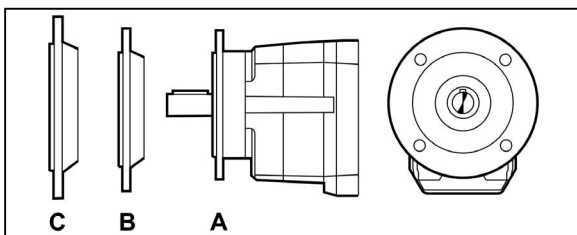

UF

UNIBOX bolt-on flange

C1/ ...C61

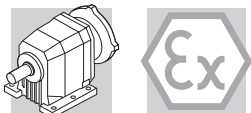

2.3 ORDERING NUMBERS

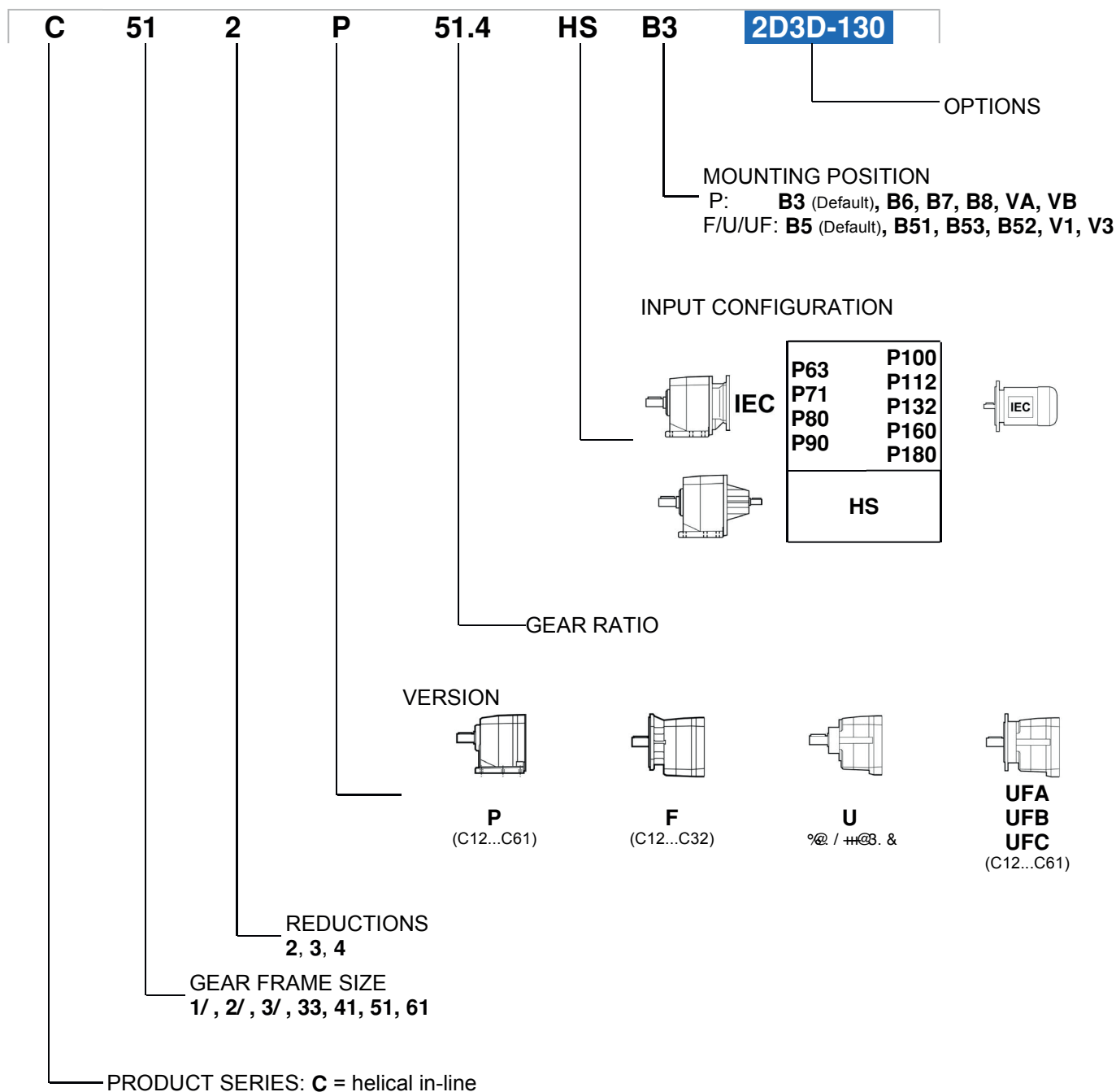

Options

The applicability of the various options is indicated in the technical data tables according to the specific configuration and gear ratio.

2D3D-160

The gear unit can be installed in zones 21 and 22 (categories 2D and 3D).
The unit's surface temperature is less than 160°C.

2D3D-130

The gear unit can be installed in zones 21 and 22 (categories 2D and 3D).
The unit's surface temperature is less than 130°C.

2G3G-T3

The gear unit can be installed in zones 1 and 2 (categories 2G and 3G).
The temperature class is T3 (max. 200 °C).

2G3G-T4

The gear unit can be installed in zones 1 and 2 (categories 2G and 3G).
The temperature class is T4 (max. 135 °C).

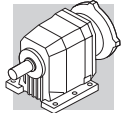

2.4 MOUNTING POSITION

C 12 P ... C 61 P

B3

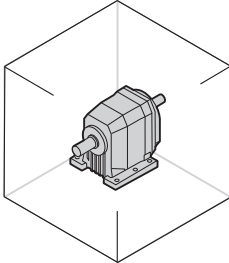

B6

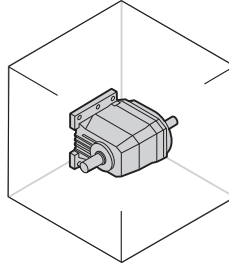

B7

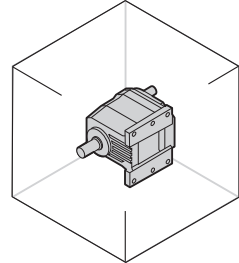

B8

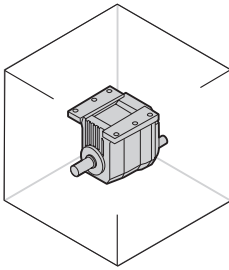

VA

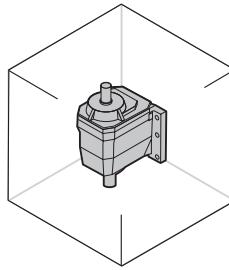

VB

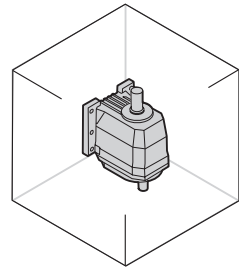

C 12 F ... C 61 F

B5

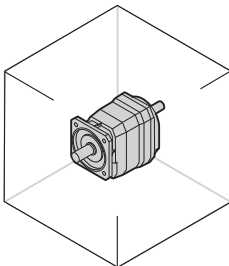

B51

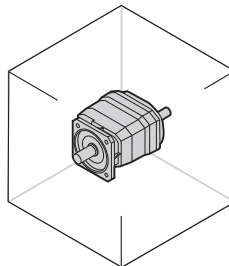

B53

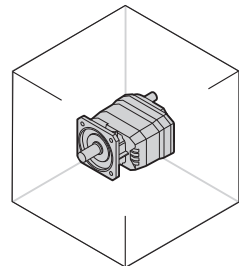

B52

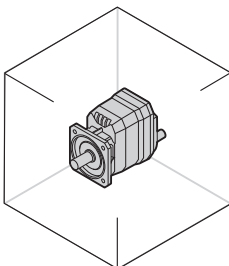

V1

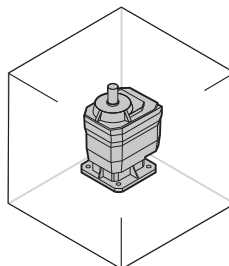

V3

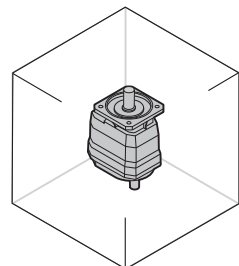

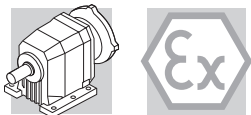

2.5 LUBRICATION

The gear units are factory-charged with long-life synthetic lubricant in the quantity suitable for the mounting position specified in the order.

For transportation purposes these units are equipped with closed filler plugs. A vented plug, which the User must replace before putting the unit into service, is supplied along with each unit.

Type C12, C22 and C32 gear units are not equipped with spill-type level plugs. Proceed as described in the User Manual when checking the minimum lubricant level.

For the reference charts of oil plugs placement and quantity of lubricant, refer to the Installation, Operation and Maintenance Manual (available on www.bonfiglioli.com).

2.6 ADMISSIBLE OVERHUNG LOADS

2.6.1 RADIAL LOADS

2.6.1.1 CALCULATING THE RESULTING OVERHUNG LOAD



External transmissions keyed onto input and/or output shaft generate loads that act radially onto same shaft.

Resulting shaft loading must be compatible with both the bearing and the shaft capacity.

Namely shaft loading (R_{c1} for input shaft, R_{c2} for output shaft), must be equal or lower than admissible overhung load capacity for shaft under study (R_{n1} for input shaft, R_{n2} for output shaft). OHL capability listed in the rating chart section.

In the formulas given below, index (1) applies to parameters relating to input shaft, whereas index (2) refers to output shaft.

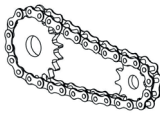
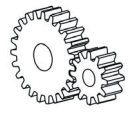
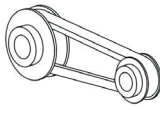
The load generated by an external transmission can be calculated with close approximation by the following equation:

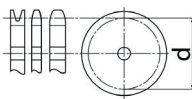
$R_c = \frac{2000 \times M \times K_r}{d}$	
$K_r = 1$	
$K_r = 1.25$	
$K_r = 1.5 - 2.0$	
M [Nm]	
d [mm]	



2.6.1.2 OVERHUNG LOADING VERIFICATION

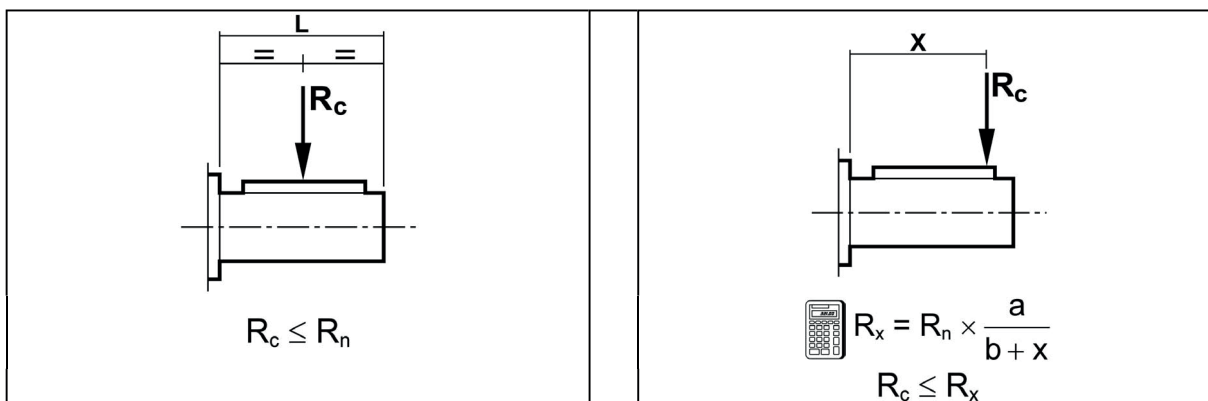

2.6.1.3 LOAD LOCATION FACTOR

	Output shaft			Input shaft		
	a	b	c	a	b	c
C 12 2	46	26	450	21	1	300
C 22 2	53	28	550	40	20	350
C 22 3	53	28	550	21	1	300
C 32 2	60.5	30.5	750	41.5	21.5	350
C 32 3	60.5	30.5	750	21	1	300
C 36 2 - C 36 3	69.5	34.5	800	51.5	26.5	450
C 36 4	69.5	34.5	800	21	1	300
C 41 2 - C 41 3	69.5	34.5	850	51.5	26.5	450
C 41 4	69.5	34.5	850	40	20	350
C 51 2 - C 51 3	76.5	36.5	900	51.5	26.5	450
C 51 4	76.5	36.5	900	41.5	21.5	350
C 61 2 - C 61 3	95.5	45.5	1000	57.5	27.5	450
C 61 4	95.5	45.5	1000	51.5	26.5	450

2.6.2 THRUST LOADS A_{n1} , A_{n2}

Permissible thrust loads on input [A_{n1}] and output [A_{n2}] shafts are obtained from the radial loading for the shaft under consideration [R_{n1}] and [R_{n2}] through the following equation:

$$A_{n1} = R_{n1} \cdot 0,2$$



$$A_{n2} = R_{n2} \cdot 0,2$$

The thrust loads calculated through these formulas apply to thrust forces occurring at the same time as rated radial loads. In the only case that no overhung load acts on the shaft the value of the admissible thrust load [A_{n1}] amounts to 50% of rated OHL [R_{n1}] on same shaft.

Where thrust loads exceed permissible value or largely prevail over radial loads, contact Bonfiglioli Riduttori for an in-depth analysis of the application.

2.7 GEARBOX RATING CHARTS

Selection example

 IEC (*)		i	n ₁ = 1400 min ⁻¹						i	n ₁ = 1400 min ⁻¹				
			n ₂ min ⁻¹	M _{n2} Nm	P _{n1} kW	R _{n2} N				n ₂ min ⁻¹	M _{n2} Nm	P _{n1} kW	R _{n1} N	R _{n2} N
1	C 51 2_7.0	7.0	200	415	9.1	5560	2	C 51 2_7.0	7	200	415	9.1	2220	5560
	C 51 2_7.8	7.8	179	420	8.3	5770		C 51 2_7.8	7.8	179	420	8.3	2300	5770
	C 51 2_8.8	8.8	159	455	8.0	5980		C 51 2_8.8	8.8	159	455	8.0	2240	5980
	C 51 2_9.8	9.8	143	450	7.1	6250		C 51 2_9.8	9.8	143	450	7.1	2330	6250
	C 51 2_11.8	11.8	119	505	6.6	6590		C 51 2_11.8	11.8	119	505	6.6	2250	6590
	C 51 2_13.1	13.1	107	490	5.8	6920		C 51 2_13.1	13.1	107	490	5.8	2360	6920
	C 51 2_15.0	15.0	93	550	5.7	7110		C 51 2_15.0	15.0	93	550	5.7	2260	7110
	C 51 2_16.6	16.6	84	535	5.0	7470		C 51 2_16.6	16.6	84	535	5.0	2370	7470
	C 51 2_18.9	18.9	74	585	4.8	7720		C 51 2_18.9	18.9	74	585	4.8	2250	7720
	C 51 2_21.0	21.0	67	550	4.0	8170		C 51 2_21.0	21.0	67	550	4.0	2390	8170
	C 51 2_23.4	23.4	60	625	4.1	8290		C 51 2_23.4	23.4	60	625	4.1	2240	8290
	C 51 2_25.9	25.9	54	555	3.3	8890		C 51 2_25.9	25.9	54	555	3.3	2420	8890
	C 51 2_29.8	29.8	47	680	3.5	8990		C 51 2_29.8	29.8	47	680	3.5	2220	8990
C 51 2_33.0	33.0	42	565	2.6	9770	C 51 2_33.0	33.0	42	565	2.6	2460	9770		
C 51 2_36.4	36.4	38	670	2.8	9810	C 51 2_36.4	36.4	38	670	2.8	2260	9810		
C 51 2_40.4	40.4	35	575	2.2	10000	C 51 2_40.4	40.4	35	575	2.2	2460	10000		
C 51 2_43.1	43.1	32	650	2.3	10000	C 51 2_43.1	43.1	32	650	2.3	2310	10000		
C 51 2_47.8	47.8	29	580	1.9	10000	C 51 2_47.8	47.8	29	580	1.9	2480	10000		

①

The gear unit can be installed

In zones 21 and 22 with surface temperature limit of 160°C

In zones 1 and 2 with temperature class limit T3 (200°C)

②

The gear unit can be installed

In zones 21 and 22 with surface temperature limit of 130°C

In zones 1 and 2 with temperature class limit T4 (135°C)

In zones 21 and 22 with surface temperature limit of 160°C

In zones 1 and 2 with temperature class limit T3 (200°C)

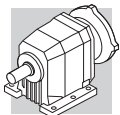

C 12



IEC (*)	i	n ₁ = 1400 min ⁻¹			i	n ₁ = 1400 min ⁻¹					
		n ₂ min ⁻¹	M _{n2} Nm	R _{n2} N		n ₂ min ⁻¹	M _{n2} Nm	P _{n1} kW	R _{n1} N	R _{n2} N	
2D3D-130—2G3G-T4	2D3D-160—2G3G-T3	C 12 2_7.6	7.6	184	32	1410		34			
		C 12 2_8.8	8.8	159	34	1480					
		C 12 2_10.1	10.1	139	36	1530					
		C 12 2_11.9	11.9	118	38	1560					
		C 12 2_13.4	13.4	104	40	1580					
		C 12 2_15.4	15.4	91	42	1610					
		C 12 2_17.2	17.2	81	44	1630					
		C 12 2_18.4	18.4	76	45	1640					
		C 12 2_20.6	20.6	68	47	1660					
		C 12 2_23.2	23.2	60	49	1680					
		C 12 2_25.4	25.4	55	51	1700					
		C 12 2_29.5	29.5	47	52	1725					
		C 12 2_32.8	32.8	43	52	1750					
		C 12 2_37.0	37.0	38	52	1780					
		C 12 2_42.3	42.3	33	52	1800					
		C 12 2_47.6	47.6	29.4	53	1830					
		C 12 2_55.2	55.2	25.4	54	1870					
C 12 2_66.2	66.2	21.1	56	1910							

(*) The values specified refer only to the gearbox output section.

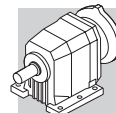
“P” input sections are dimensioned for maximum installable motor power (see the chart for motor availability - page 25)

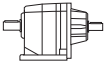

C 22

 IEC (*)	i	n ₁ = 1400 min ⁻¹				i	n ₁ = 1400 min ⁻¹							
		n ₂ min ⁻¹	M _{n2} Nm	R _{n2} N			n ₂ min ⁻¹	M _{n2} Nm	P _{n1} kW	R _{n1} N	R _{n2} N			
2D3D-130—2G3G-T4	2D3D-160—2G3G-T3	C 22 2_7.1	7.1	197	75	1950	2D3D-160—2G3G-T3	C 22 2_7.1	7.1	197	75	1.6	1280	1950
		C 22 2_8.7	8.7	161	80	2045		C 22 2_8.7	8.7	161	80	1.4	1270	2045
		C 22 2_9.6	9.6	146	85	2150		C 22 2_9.6	9.6	146	85	1.4	1280	2150
		C 22 2_11.1	11.1	126	88	2230		C 22 2_11.1	11.1	126	88	1.2	1240	2230
		C 22 2_12.4	12.4	113	90	2350		C 22 2_12.4	12.4	113	90	1.1	1290	2350
		C 22 2_14.5	14.5	97	95	2415		C 22 2_14.5	14.5	97	95	1.0	1280	2415
		C 22 2_15.8	15.8	89	100	2530		C 22 2_15.8	15.8	89	100	0.98	1280	2530
		C 22 2_18.1	18.1	77	105	2610		C 22 2_18.1	18.1	77	105	0.90	1230	2610
		C 22 2_20.0	20.0	70	110	2730		C 22 2_20.0	20.0	70	110	0.85	1250	2730
		C 22 2_21.5	21.5	65	112	2780		C 22 2_21.5	21.5	65	112	0.80	1190	2780
	2D3D-130—2G3G-T4	2D3D-160—2G3G-T3	C 22 2_24.3	24.3	58	115	2920	C 22 2_24.3	24.3	58	115	0.73	1250	2920
			C 22 2_27.2	27.2	51	120	3010	C 22 2_27.2	27.2	51	120	0.68	1295	3010
			C 22 2_29.6	29.6	47	125	3110	C 22 2_29.6	29.6	47	125	0.65	1260	3110
			C 22 2_33.1	33.1	42	130	3190	C 22 2_33.1	33.1	42	130	0.61	1240	3190
			C 22 2_36.8	36.8	38	135	3340	C 22 2_36.8	36.8	38	135	0.57	1200	3340
			C 22 2_43.3	43.3	32	130	3610	C 22 2_43.3	43.3	32	130	0.46	1270	3610
			C 22 2_48.6	48.6	28.8	130	3960	C 22 2_48.6	48.6	28.8	130	0.41	1325	3960
			C 22 2_54.7	54.7	25.6	115	4070	C 22 2_54.7	54.7	25.6	115	0.32	1300	4070
			C 22 2_63.3	63.3	22.1	105	4370	C 22 2_63.3	63.3	22.1	105	0.26	1320	4370
			2D3D-130—2G3G-T4	2D3D-160—2G3G-T3	C 22 3_60.0	60.0	23.3	145	3970					
C 22 3_65.3	65.3	21.4			145	4160								
C 22 3_74.8	74.8	18.7			147	4320								
C 22 3_82.6	82.6	16.9			150	4550								
C 22 3_88.5	88.5	15.8			152	4710								
C 22 3_100.2	100.2	14.0			155	4880								
C 22 3_112.0	112.0	12.5			157	4940								
C 22 3_122.2	122.2	11.5			160	5000								
C 22 3_136.5	136.5	10.3			162	5000								
C 22 3_151.7	151.7	9.2			165	5000								
C 22 3_178.5	178.5	7.8	165	5000										
C 22 3_200.7	200.7	7.0	160	5000										
C 22 3_225.8	225.8	6.2	160	5000										
C 22 3_261.0	261.0	5.4	155	5000										



36

(*) The values specified refer only to the gearbox output section.

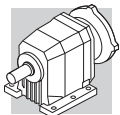
"P" input sections are dimensioned for maximum installable motor power (see the chart for motor availability - page 25)

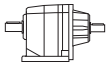

C 32

 IEC (*)	i	n ₁ = 1400 min ⁻¹				i	n ₁ = 1400 min ⁻¹								
		n ₂ min ⁻¹	M _{n2} Nm	R _{n2} N			n ₂ min ⁻¹	M _{n2} Nm	P _{n1} kW	R _{n1} N	R _{n2} N				
2D3D-130—2G3G-T4	2D3D-160—2G3G-T3	C 32 2_7.2	7.2	194	115	2840	2D3D-130—2G3G-T4	2D3D-160—2G3G-T3	C 32 2_7.2	7.2	194	115	2.5	1780	2840
		C 32 2_8.5	8.5	165	122	3010			C 32 2_8.5	8.5	165	122	2.2	1780	3010
		C 32 2_9.3	9.3	151	130	3080			C 32 2_9.3	9.3	151	130	2.2	1780	3080
		C 32 2_11.2	11.2	125	134	3300			C 32 2_11.2	11.2	125	134	1.8	1780	3300
		C 32 2_12.3	12.3	114	140	3390			C 32 2_12.3	12.3	114	140	1.8	1780	3390
		C 32 2_14.1	14.1	99	144	3580			C 32 2_14.1	14.1	99	144	1.6	1780	3580
		C 32 2_15.6	15.6	90	155	3650			C 32 2_15.6	15.6	90	155	1.5	1780	3650
		C 32 2_18.2	18.2	77	158	3890			C 32 2_18.2	18.2	77	158	1.3	1780	3890
		C 32 2_20.1	20.1	70	170	3970			C 32 2_20.1	20.1	70	170	1.3	1780	3970
		C 32 2_22.9	22.9	61	176	4150			C 32 2_22.9	22.9	61	176	1.2	1780	4150
		C 32 2_25.1	25.1	56	185	4260			C 32 2_25.1	25.1	56	185	1.1	1780	4260
		C 32 2_26.9	26.9	52	187	4350			C 32 2_26.9	26.9	52	187	1.1	1780	4350
		C 32 2_29.8	29.8	47	195	4520			C 32 2_29.8	29.8	47	195	1.0	1780	4520
		C 32 2_33.1	33.1	42	195	4715			C 32 2_33.1	33.1	42	195	0.91	1780	4715
	C 32 2_36.1	36.1	39	195	4880	C 32 2_36.1	36.1	39	195	0.83	1780	4880			
	C 32 2_40.7	40.7	34	197	5165	C 32 2_40.7	40.7	34	197	0.75	1780	5165			
	C 32 2_45.3	45.3	31	200	5320	C 32 2_45.3	45.3	31	200	0.68	1780	5320			
	C 32 2_52.4	52.4	26.7	205	5500	C 32 2_52.4	52.4	26.7	205	0.60	1780	5500			
	C 32 2_59.4	59.4	23.6	200	5500	C 32 2_59.4	59.4	23.6	200	0.52	1780	5500			
	C 32 2_66.8	66.8	21.0	155	5500	C 32 2_66.8	66.8	21.0	155	0.36	1780	5500			
	C 32 3_74.7	74.7	18.7	205	5500										
	C 32 3_82.6	82.6	16.9	220	5500										
	C 32 3_94.2	94.2	14.9	225	5500										
	C 32 3_103.3	103.3	13.6	230	5500										
	C 32 3_110.6	110.6	12.7	232	5500										
	C 32 3_122.4	122.4	11.4	235	5500										
	C 32 3_136.0	136.0	10.3	237	5500										
	C 32 3_148.4	148.4	9.4	240	5500										
C 32 3_167.4	167.4	8.4	245	5500											
C 32 3_186.0	186.0	7.5	250	5500											
C 32 3_215.6	215.6	6.5	255	5500											
C 32 3_244.2	244.2	5.7	255	5500											
C 32 3_274.7	274.7	5.1	255	5500											

(*) The values specified refer only to the gearbox output section.

“P” input sections are dimensioned for maximum installable motor power (see the chart for motor availability - page 25)

C 36



IEC (*)	i	n ₁ = 1400 min ⁻¹			IEC (*)	i	n ₁ = 1400 min ⁻¹								
		n ₂ min ⁻¹	M _{n2} Nm	R _{n2} N			n ₂ min ⁻¹	M _{n2} Nm	P _{n1} kW	R _{n1} N	R _{n2} N				
2D3D-130—2G3G-T4	2D3D-160—2G3G-T3	C 36 2_6.8	6.8	206	205	2710	2D3D-160—2G3G-T3	C 36 2_6.8	6.8	206	205	4.7	1810	2710	
		C 36 2_8.0	8.0	175	213	2910		C 36 2_8.0	8.0	175	213	4.1	1820	2910	
		C 36 2_8.8	8.8	159	225	3000		C 36 2_8.8	8.8	159	225	3.9	1820	3000	
		C 36 2_10.6	10.6	132	227	3271		C 36 2_10.6	10.6	132	227	3.3	1845	3271	
		C 36 2_11.7	11.7	120	230	3420		C 36 2_11.7	11.7	120	230	3.0	1870	3420	
		C 36 2_13.3	13.3	105	232	3587		C 36 2_13.3	13.3	105	232	2.7	1880	3587	
		C 36 2_14.8	14.8	95	235	3760		C 36 2_14.8	14.8	95	235	2.5	1900	3760	
		C 36 2_17.2	17.2	81	237	4020		C 36 2_17.2	17.2	81	237	2.1	1910	4020	
		C 36 2_19.0	19.0	74	240	4170		C 36 2_19.0	19.0	74	240	1.9	1930	4170	
		2D3D-130—2G3G-T4	2D3D-160—2G3G-T3	C 36 3_22.1	22.1	63		240	4450	C 36 3_22.1	22.1	63	240	1.7	2210
	C 36 3_26.2			26.2	53	254	4706	C 36 3_26.2	26.2	53	254	1.5	2205	4706	
	C 36 3_28.7			28.7	49	270	4810	C 36 3_28.7	28.7	49	270	1.5	2210	4810	
	C 36 3_34.6			34.6	40	286	5115	C 36 3_34.6	34.6	40	286	1.3	2210	5115	
	C 36 3_38.1			38.1	37	305	5250	C 36 3_38.1	38.1	37	305	1.3	2210	5250	
	C 36 3_43.5			43.5	32	319	5490	C 36 3_43.5	43.5	32	319	1.2	2205	5490	
	C 36 3_48.2			48.2	29.0	335	5650	C 36 3_48.2	48.2	29.0	335	1.1	2200	5650	
	C 36 3_56.2			56.2	24.9	354	5947	C 36 3_56.2	56.2	24.9	354	0.99	2190	5947	
	C 36 3_62.0			62.0	22.6	375	6100	C 36 3_62.0	62.0	22.6	375	0.95	2190	6100	
	C 36 3_70.8			70.8	19.8	382	6294	C 36 3_70.8	70.8	19.8	382	0.85	2195	6294	
	C 36 3_77.6			77.6	18.0	390	6500	C 36 3_77.6	77.6	18.0	390	0.79	2200	6500	
	C 36 3_83.1			83.1	16.8	395	6500	C 36 3_83.1	83.1	16.8	395	0.75	2200	6500	
	C 36 3_91.9			91.9	15.2	400	6500	C 36 3_91.9	91.9	15.2	400	0.69	2200	6500	
	C 36 3_102.2			102.2	13.7	405	6500	C 36 3_102.2	102.2	13.7	405	0.62	2200	6500	
	C 36 3_111.5			111.5	12.6	410	6500	C 36 3_111.5	111.5	12.6	410	0.58	2200	6500	
	C 36 3_125.8			125.8	11.1	417	6500	C 36 3_125.8	125.8	11.1	417	0.52	2200	6500	
	C 36 3_139.8			139.8	10.0	425	6500	C 36 3_139.8	139.8	10.0	425	0.48	2200	6500	
	C 36 3_162.0			162.0	8.6	435	6500	C 36 3_162.0	162.0	8.6	435	0.42	2200	6500	
	C 36 3_183.5	183.5	7.6	442	6500	C 36 3_183.5	183.5	7.6	442	0.38	2195	6500			
C 36 3_206.4	206.4	6.8	450	6500	C 36 3_206.4	206.4	6.8	450	0.34	2190	6500				
2D3D-130—2G3G-T4	2D3D-160—2G3G-T3	C 36 4_230.9	230.9	6.1	450	6500	2D3D-160—2G3G-T3	2D3D-160—2G3G-T3	40		C 36 4_230.9	230.9	6.1	450	6500
		C 36 4_255.0	255.0	5.5	450	6500					C 36 4_255.0	255.0	5.5	450	6500
		C 36 4_290.9	290.9	4.8	450	6500					C 36 4_290.9	290.9	4.8	450	6500
		C 36 4_318.9	318.9	4.4	450	6500					C 36 4_318.9	318.9	4.4	450	6500
		C 36 4_341.7	341.7	4.1	450	6500					C 36 4_341.7	341.7	4.1	450	6500
		C 36 4_377.9	377.9	3.7	450	6500					C 36 4_377.9	377.9	3.7	450	6500
		C 36 4_420.2	420.2	3.3	450	6500					C 36 4_420.2	420.2	3.3	450	6500
		C 36 4_458.4	458.4	3.1	450	6500					C 36 4_458.4	458.4	3.1	450	6500
		C 36 4_517.2	517.2	2.7	450	6500					C 36 4_517.2	517.2	2.7	450	6500
		C 36 4_574.7	574.7	2.4	450	6500					C 36 4_574.7	574.7	2.4	450	6500
C 36 4_665.9	665.9	2.1	450	6500	C 36 4_665.9	665.9	2.1	450	6500						
C 36 4_754.2	754.2	1.9	450	6500	C 36 4_754.2	754.2	1.9	450	6500						
C 36 4_848.5	848.5	1.6	450	6500	C 36 4_848.5	848.5	1.6	450	6500						

(*) The values specified refer only to the gearbox output section.

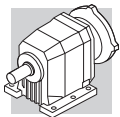
“P” input sections are dimensioned for maximum installable motor power (see the chart for motor availability - page 25)



C 41

 IEC (*)	i	n ₁ = 1400 min ⁻¹					i	n ₁ = 1400 min ⁻¹						
		n ₂ min ⁻¹	M _{n2} Nm	P _{n1} kW	R _{n2} N			n ₂ min ⁻¹	M _{n2} Nm	P _{n1} kW	R _{n1} N	R _{n2} N		
2D3D-130—2G3G-T4 2D3D-160—2G3G-T3	C 41 2_6.4	6.4	219	200	4.8	3260	2D3D-130—2G3G-T4 2D3D-160—2G3G-T3	C 41 2_6.4	6.4	219	200	4.8	2600	3260
	C 41 2_7.1	7.1	197	205	4.5	3410		C 41 2_7.1	7.1	197	205	4.5	2640	3410
	C 41 2_8.6	8.6	163	220	3.9	3600		C 41 2_8.6	8.6	163	220	3.9	2610	3600
	C 41 2_9.6	9.6	146	225	3.6	3790		C 41 2_9.6	9.6	146	225	3.6	2660	3790
	C 41 2_11.2	11.2	125	245	3.4	3920		C 41 2_11.2	11.2	125	245	3.4	2620	3920
	C 41 2_12.4	12.4	113	245	3.0	4120		C 41 2_12.4	12.4	113	245	3.0	2670	4120
	C 41 2_14.2	14.2	99	260	2.8	4280		C 41 2_14.2	14.2	99	260	2.8	2620	4280
	C 41 2_15.8	15.8	89	260	2.5	4500		C 41 2_15.8	15.8	89	260	2.5	2680	4500
	C 41 2_17.8	17.8	79	275	2.4	4630		C 41 2_17.8	17.8	79	275	2.4	2630	4630
	C 41 2_19.8	19.8	71	280	2.2	4850		C 41 2_19.8	19.8	71	280	2.2	2670	4850
	C 41 2_22.6	22.6	62	300	2.0	5010		C 41 2_22.6	22.6	62	300	2.0	2610	5010
	C 41 2_25.0	25.0	56	300	1.8	5260		C 41 2_25.0	25.0	56	300	1.8	2660	5260
	C 41 2_28.3	28.3	49	325	1.8	5400		C 41 2_28.3	28.3	49	325	1.8	2600	5400
	C 41 2_31.4	31.4	45	325	1.6	5670		C 41 2_31.4	31.4	45	325	1.6	2650	5670
	C 41 2_33.4	33.4	42	335	1.5	5740		C 41 2_33.4	33.4	42	335	1.5	2600	5740
	C 41 2_37.1	37.1	38	325	1.4	6080		C 41 2_37.1	37.1	38	325	1.4	2660	6080
	C 41 2_44.8	44.8	31	330	1.1	6550		C 41 2_44.8	44.8	31	330	1.1	2670	6550
	C 41 3_28.5	28.5	49	335	1.9	5360		C 41 3_28.5	28.5	49	335	1.9	2900	5360
	C 41 3_31.2	31.2	45	360	1.8	5480		C 41 3_31.2	31.2	45	360	1.8	2900	5480
	C 41 3_36.8	36.8	38	370	1.6	5810		C 41 3_36.8	36.8	38	370	1.6	2900	5810
	C 41 3_40.3	40.3	35	410	1.6	5880		C 41 3_40.3	40.3	35	410	1.6	2900	5880
	C 41 3_47.0	47.0	29.8	415	1.4	6240		C 41 3_47.0	47.0	29.8	415	1.4	2890	6240
	C 41 3_51.5	51.5	27.2	430	1.3	6450		C 41 3_51.5	51.5	27.2	430	1.3	2910	6450
	C 41 3_58.7	58.7	23.9	450	1.2	6700		C 41 3_58.7	58.7	23.9	450	1.2	2890	6700
	C 41 3_64.3	64.3	21.8	445	1.1	7000		C 41 3_64.3	64.3	21.8	445	1.1	2910	7000
	C 41 3_74.4	74.4	18.8	490	1.0	7000		C 41 3_74.4	74.4	18.8	490	1.0	2880	7000
	C 41 3_81.5	81.5	17.2	460	0.89	7000		C 41 3_81.5	81.5	17.2	460	0.89	2920	7000
	C 41 3_93.3	93.3	15.0	545	0.92	7000		C 41 3_93.3	93.3	15.0	545	0.92	2860	7000
	C 41 3_102.3	102.3	13.7	475	0.73	7000		C 41 3_102.3	102.3	13.7	475	0.73	2920	7000
	C 41 3_110.1	110.1	12.7	570	0.82	7000		C 41 3_110.1	110.1	12.7	570	0.82	2860	7000
	C 41 3_120.6	120.6	11.6	490	0.64	7000		C 41 3_120.6	120.6	11.6	490	0.64	2920	7000
	C 41 3_132.9	132.9	10.5	590	0.70	7000		C 41 3_132.9	132.9	10.5	590	0.70	2860	7000
	C 41 3_145.6	145.6	9.6	505	0.55	7000		C 41 3_145.6	145.6	9.6	505	0.55	2920	7000
	C 41 3_164.1	164.1	8.5	600	0.58	7000		C 41 3_164.1	164.1	8.5	600	0.58	2860	7000
	C 41 3_179.9	179.9	7.8	520	0.46	7000		C 41 3_179.9	179.9	7.8	520	0.46	2920	7000
	C 41 3_190.8	190.8	7.3	600	0.50	7000		C 41 3_190.8	190.8	7.3	600	0.50	2860	7000
	C 41 3_209.1	209.1	6.7	530	0.40	7000		C 41 3_209.1	209.1	6.7	530	0.40	2920	7000
	C 41 4_239.9	239.9	5.8	600	0.41	7000		C 41 4_239.9	239.9	5.8	600	0.41	1050	7000
	C 41 4_263.0	263.0	5.3	550	0.34	7000		C 41 4_263.0	263.0	5.3	550	0.34	1090	7000
	C 41 4_304.2	304.2	4.6	600	0.32	7000		C 41 4_304.2	304.2	4.6	600	0.32	1110	7000
	C 41 4_333.4	333.4	4.2	570	0.28	7000		C 41 4_333.4	333.4	4.2	570	0.28	1140	7000
	C 41 4_381.8	381.8	3.7	600	0.25	7000		C 41 4_381.8	381.8	3.7	600	0.25	1150	7000
	C 41 4_418.5	418.5	3.3	590	0.23	7000		C 41 4_418.5	418.5	3.3	590	0.23	1170	7000
	C 41 4_450.2	450.2	3.1	600	0.22	7000		C 41 4_450.2	450.2	3.1	600	0.22	1180	7000
	C 41 4_493.5	493.5	2.8	600	0.20	7000		C 41 4_493.5	493.5	2.8	600	0.20	1190	7000
	C 41 4_543.5	543.5	2.6	600	0.18	7000		C 41 4_543.5	543.5	2.6	600	0.18	1210	7000
	C 41 4_595.8	595.8	2.3	600	0.16	7000		C 41 4_595.8	595.8	2.3	600	0.16	1700	7000
	C 41 4_671.3	671.3	2.1	600	0.14	7000		C 41 4_671.3	671.3	2.1	600	0.14	1230	7000
C 41 4_735.9	735.9	1.9	600	0.13	7000	C 41 4_735.9	735.9	1.9	600	0.13	1240	7000		
C 41 4_780.4	780.4	1.8	600	0.12	7000	C 41 4_780.4	780.4	1.8	600	0.12	1240	7000		
C 41 4_855.5	855.5	1.6	600	0.11	7000	C 41 4_855.5	855.5	1.6	600	0.11	1250	7000		



42

(*) The values specified refer only to the gearbox output section.

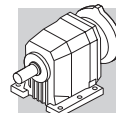
"P" input sections are dimensioned for maximum installable motor power (see the chart for motor availability - page 25)



C 51

 IEC (*)	i	n ₁ = 1400 min ⁻¹					i	n ₁ = 1400 min ⁻¹						
		n ₂ min ⁻¹	M _{n2} Nm	P _{n1} kW	R _{n2} N			n ₂ min ⁻¹	M _{n2} Nm	P _{n1} kW	R _{n1} N	R _{n2} N		
2D3D-130—2G3G-T4 2D3D-160—2G3G-T3	C 51 2_7.0	7.0	200	415	9.1	5560	2D3D-130—2G3G-T4 2D3D-160—2G3G-T3	C 51 2_7.0	7	200	415	9.1	2220	5560
	C 51 2_7.8	7.8	179	420	8.3	5770		C 51 2_7.8	7.8	179	420	8.3	2300	5770
	C 51 2_8.8	8.8	159	455	8.0	5980		C 51 2_8.8	8.8	159	455	8.0	2240	5980
	C 51 2_9.8	9.8	143	450	7.1	6250		C 51 2_9.8	9.8	143	450	7.1	2330	6250
	C 51 2_11.8	11.8	119	505	6.6	6590		C 51 2_11.8	11.8	119	505	6.6	2250	6590
	C 51 2_13.1	13.1	107	490	5.8	6920		C 51 2_13.1	13.1	107	490	5.8	2360	6920
	C 51 2_15.0	15.0	93	550	5.7	7110		C 51 2_15.0	15.0	93	550	5.7	2260	7110
	C 51 2_16.6	16.6	84	535	5.0	7470		C 51 2_16.6	16.6	84	535	5.0	2370	7470
	C 51 2_18.9	18.9	74	585	4.8	7720		C 51 2_18.9	18.9	74	585	4.8	2250	7720
	C 51 2_21.0	21.0	67	550	4.0	8170		C 51 2_21.0	21.0	67	550	4.0	2390	8170
	C 51 2_23.4	23.4	60	625	4.1	8290		C 51 2_23.4	23.4	60	625	4.1	2240	8290
	C 51 2_25.9	25.9	54	555	3.3	8890		C 51 2_25.9	25.9	54	555	3.3	2420	8890
	C 51 2_29.8	29.8	47	680	3.5	8990		C 51 2_29.8	29.8	47	680	3.5	2220	8990
	C 51 2_33.0	33.0	42	565	2.6	9770		C 51 2_33.0	33.0	42	565	2.6	2460	9770
	C 51 2_36.4	36.4	38	670	2.8	9810		C 51 2_36.4	36.4	38	670	2.8	2260	9810
	C 51 2_40.4	40.4	35	575	2.2	10000		C 51 2_40.4	40.4	35	575	2.2	2460	10000
	C 51 2_43.1	43.1	32	650	2.3	10000		C 51 2_43.1	43.1	32	650	2.3	2310	10000
	C 51 2_47.8	47.8	29.3	580	1.9	10000		C 51 2_47.8	47.8	29.3	580	1.9	2480	10000
	C 51 2_51.4	51.4	27.2	595	1.8	10000		C 51 2_51.4	51.4	27.2	595	1.8	2390	10000
	C 51 2_57.0	57.0	24.6	595	1.6	10000		C 51 2_57.0	57.0	24.6	595	1.6	2470	10000
	C 51 3_21.8	21.8	64	625	4.5	8010		C 51 3_21.8	21.8	64	625	4.5	2690	8010
	C 51 3_23.9	23.9	59	640	4.2	8300		C 51 3_23.9	23.9	59	640	4.2	2720	8300
	C 51 3_27.4	27.4	51	675	3.9	8650		C 51 3_27.4	27.4	51	675	3.9	2710	8650
	C 51 3_30.1	30.1	47	685	3.6	8990		C 51 3_30.1	30.1	47	685	3.6	2740	8990
	C 51 3_37.0	37.0	38	740	3.2	9570		C 51 3_37.0	37.0	38	740	3.2	2720	9570
	C 51 3_40.5	40.5	35	750	2.9	9950		C 51 3_40.5	40.5	35	750	2.9	2750	9950
	C 51 3_46.7	46.7	30	800	2.7	10000		C 51 3_46.7	46.7	30	800	2.7	2730	10000
	C 51 3_51.2	51.2	27.3	805	2.5	10000		C 51 3_51.2	51.2	27.3	805	2.5	2760	10000
	C 51 3_59.0	59.0	23.7	850	2.3	10000		C 51 3_59.0	59.0	23.7	850	2.3	2730	10000
	C 51 3_64.6	64.6	21.7	845	2.1	10000		C 51 3_64.6	64.6	21.7	845	2.1	2770	10000
	C 51 3_72.9	72.9	19.2	910	2.0	10000		C 51 3_72.9	72.9	19.2	910	2.0	2720	10000
	C 51 3_79.9	79.9	17.5	875	1.7	10000		C 51 3_79.9	79.9	17.5	875	1.7	2770	10000
	C 51 3_93.0	93.0	15.1	990	1.7	10000		C 51 3_93.0	93.0	15.1	990	1.7	2710	10000
	C 51 3_101.8	101.8	13.8	905	1.4	10000		C 51 3_101.8	101.8	13.8	905	1.4	2780	10000
	C 51 3_113.6	113.6	12.3	1000	1.4	10000		C 51 3_113.6	113.6	12.3	1000	1.4	2720	10000
	C 51 3_124.4	124.4	11.3	935	1.2	10000		C 51 3_124.4	124.4	11.3	935	1.2	2780	10000
	C 51 3_134.6	134.6	10.4	1000	1.2	10000		C 51 3_134.6	134.6	10.4	1000	1.2	2730	10000
	C 51 3_147.4	147.4	9.5	960	1.0	10000		C 51 3_147.4	147.4	9.5	960	1.0	2780	10000
	C 51 3_160.5	160.5	8.7	1000	0.99	10000		C 51 3_160.5	160.5	8.7	1000	0.99	2740	10000
	C 51 3_175.8	175.8	8.0	985	0.89	10000		C 51 3_175.8	175.8	8.0	985	0.89	2780	10000
	C 51 3_197.9	197.9	7.1	1000	0.80	10000		C 51 3_197.9	197.9	7.1	1000	0.80	2740	10000
	C 51 3_216.7	216.7	6.5	1000	0.73	10000		C 51 3_216.7	216.7	6.5	1000	0.73	2780	10000
C 51 4_240.9	240.9	5.8	1000	0.67	10000	C 51 4_240.9	240.9	5.8	1000	0.67	1600	10000		
C 51 4_263.8	263.8	5.3	1000	0.61	10000	C 51 4_263.8	263.8	5.3	1000	0.61	1660	10000		
C 51 4_297.8	297.8	4.7	1000	0.54	10000	C 51 4_297.8	297.8	4.7	1000	0.54	1680	10000		
C 51 4_326.1	326.1	4.3	1000	0.50	10000	C 51 4_326.1	326.1	4.3	1000	0.50	1700	10000		
C 51 4_379.6	379.6	3.7	1000	0.43	10000	C 51 4_379.6	379.6	3.7	1000	0.43	1700	10000		
C 51 4_415.7	415.7	3.4	1000	0.39	10000	C 51 4_415.7	415.7	3.4	1000	0.39	1700	10000		
C 51 4_463.9	463.9	3.0	1000	0.35	10000	C 51 4_463.9	463.9	3.0	1000	0.35	1700	10000		
C 51 4_508.0	508.0	2.8	1000	0.32	10000	C 51 4_508.0	508.0	2.8	1000	0.32	1700	10000		
C 51 4_549.7	549.7	2.5	1000	0.30	10000	C 51 4_549.7	549.7	2.5	1000	0.30	1700	10000		
C 51 4_602.0	602.0	2.3	1000	0.27	10000	C 51 4_602.0	602.0	2.3	1000	0.27	1700	10000		
C 51 4_655.4	655.4	2.1	1000	0.25	10000	C 51 4_655.4	655.4	2.1	1000	0.25	1700	10000		
C 51 4_717.7	717.7	2.0	1000	0.23	10000	C 51 4_717.7	717.7	2.0	1000	0.23	1700	10000		
C 51 4_808.0	808.0	1.7	1000	0.20	10000	C 51 4_808.0	808.0	1.7	1000	0.20	1700	10000		
C 51 4_884.9	884.9	1.6	1000	0.18	10000	C 51 4_884.9	884.9	1.6	1000	0.18	1700	10000		



44

(*) The values specified refer only to the gearbox output section.

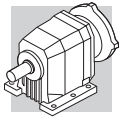
"P" input sections are dimensioned for maximum installable motor power (see the chart for motor availability - page 25)



C 61

 IEC (*)	i	n ₁ = 1400 min ⁻¹					i	n ₁ = 1400 min ⁻¹								
		n ₂ min ⁻¹	M _{n2} Nm	P _{n1} kW	R _{n2} N			n ₂ min ⁻¹	M _{n2} Nm	P _{n1} kW	R _{n1} N	R _{n2} N				
2D3D-130—2G3G-T4	2D3D-160—2G3G-T3	C 61 2_6.7	6.7	209	995	23.0	5950	C 61 2_6.7	6.7	209	995	23.0	2700	5950		
		C 61 2_7.5	7.5	187	825	17.0	6880	C 61 2_7.5	7.5	187	825	17.0	2850	6880		
		C 61 2_8.8	8.8	159	1015	17.8	6750	C 61 2_8.8	8.8	159	1015	17.8	2900	6750		
		C 61 2_9.8	9.8	143	840	13.2	7730	C 61 2_9.8	9.8	143	840	13.2	2980	7730		
		C 61 2_10.9	10.9	128	1025	14.5	7450	C 61 2_10.9	10.9	128	1025	14.5	2940	7450		
		C 61 2_12.1	12.1	116	850	10.8	8450	C 61 2_12.1	12.1	116	850	10.8	2940	8450		
		C 61 2_14.3	14.3	98	1045	11.3	8420	C 61 2_14.3	14.3	98	1045	11.3	3590	8420		
		C 61 2_15.9	15.9	88	865	8.4	9480	C 61 2_15.9	15.9	88	865	8.4	3590	9480		
		C 61 2_17.7	17.7	79	1060	9.2	9220	C 61 2_17.7	17.7	79	1060	9.2	3700	9220		
		C 61 2_19.6	19.6	71	875	6.9	10300	C 61 2_19.6	19.6	71	875	6.9	3700	10300		
		C 61 2_22.4	22.4	63	1075	7.4	10200	C 61 2_22.4	22.4	63	1075	7.4	3810	10200		
		C 61 2_24.8	24.8	56	890	5.5	11400	C 61 2_24.8	24.8	56	890	5.5	3810	11400		
		C 61 2_27.4	27.4	51	1085	6.1	11200	C 61 2_27.4	27.4	51	1085	6.1	3880	11200		
		C 61 2_30.4	30.4	46	900	4.6	12300	C 61 2_30.4	30.4	46	900	4.6	3880	12300		
		C 61 2_34.2	34.2	41	1035	4.7	12400	C 61 2_34.2	34.2	41	1035	4.7	4050	12400		
		C 61 2_38.0	38.0	37	910	3.7	13500	C 61 2_38.0	38.0	37	910	3.7	4090	13500		
		2D3D-130—2G3G-T4	2D3D-160—2G3G-T3	C 61 3_26.8	26.8	52	995	5.9	11300	C 61 3_26.8	26.8	52	995	5.9	3510	11300
				C 61 3_29.4	29.4	48	1020	5.5	11800	C 61 3_29.4	29.4	48	1020	5.5	3540	11800
				C 61 3_33.0	33.0	42	1060	5.1	12200	C 61 3_33.0	33.0	42	1060	5.1	3520	12200
				C 61 3_36.1	36.1	39	1085	4.8	12600	C 61 3_36.1	36.1	39	1085	4.8	3560	12600
	C 61 3_43.4			43.4	32	1155	4.2	13400	C 61 3_43.4	43.4	32	1155	4.2	3530	13400	
	C 61 3_47.6			47.6	29.4	1180	3.9	13900	C 61 3_47.6	47.6	29.4	1180	3.9	3560	13900	
	C 61 3_53.5			53.5	26.2	1235	3.7	14300	C 61 3_53.5	53.5	26.2	1235	3.7	3520	14300	
	C 61 3_58.6			58.6	23.9	1265	3.4	14900	C 61 3_58.6	58.6	23.9	1265	3.4	3560	14900	
	C 61 3_67.7			67.7	20.7	1340	3.1	15500	C 61 3_67.7	67.7	20.7	1340	3.1	3510	15500	
	C 61 3_74.2			74.2	18.9	1370	2.9	16000	C 61 3_74.2	74.2	18.9	1370	2.9	3550	16000	
	C 61 3_83.0			83.0	16.9	1410	2.7	16000	C 61 3_83.0	83.0	16.9	1410	2.7	3500	16000	
	C 61 3_91.0			91.0	15.4	1440	2.5	16000	C 61 3_91.0	91.0	15.4	1440	2.5	3540	16000	
	C 61 3_103.6			103.6	13.5	1500	2.3	16000	C 61 3_103.6	103.6	13.5	1500	2.3	3490	16000	
	C 61 3_113.6			113.6	12.3	1515	2.1	16000	C 61 3_113.6	113.6	12.3	1515	2.1	3540	16000	
	C 61 3_128.1			128.1	10.9	1600	2.0	16000	C 61 3_128.1	128.1	10.9	1600	2.0	3470	16000	
	C 61 3_140.5			140.5	10.0	1565	1.8	16000	C 61 3_140.5	140.5	10.0	1565	1.8	3540	16000	
	C 61 3_150.0			150.0	9.3	1600	1.7	16000	C 61 3_150.0	150.0	9.3	1600	1.7	3480	16000	
	C 61 3_164.5			164.5	8.5	1600	1.5	16000	C 61 3_164.5	164.5	8.5	1600	1.5	3540	16000	
	C 61 3_178.6			178.6	7.8	1600	1.4	16000	C 61 3_178.6	178.6	7.8	1600	1.4	3490	16000	
	C 61 3_195.8			195.8	7.2	1600	1.3	16000	C 61 3_195.8	195.8	7.2	1600	1.3	3540	16000	
	2D3D-130—2G3G-T4		C 61 4_217.4	217.4	6.4	1600	1.2	16000	C 61 4_217.4	217.4	6.4	1600	1.2	2470	16000	
			C 61 4_238.3	238.3	5.9	1600	1.1	16000	C 61 4_238.3	238.3	5.9	1600	1.1	2520	16000	
			C 61 4_275.3	275.3	5.1	1600	0.94	16000	C 61 4_275.3	275.3	5.1	1600	0.94	2580	16000	
			C 61 4_301.7	301.7	4.6	1600	0.86	16000	C 61 4_301.7	301.7	4.6	1600	0.86	2620	16000	
C 61 4_337.7			337.7	4.1	1600	0.77	16000	C 61 4_337.7	337.7	4.1	1600	0.77	2660	16000		
C 61 4_370.1			370.1	3.8	1600	0.70	16000	C 61 4_370.1	370.1	3.8	1600	0.70	2690	16000		
C 61 4_421.5			421.5	3.3	1600	0.62	16000	C 61 4_421.5	421.5	3.3	1600	0.62	2730	16000		
C 61 4_462.0			462.0	3.0	1600	0.56	16000	C 61 4_462.0	462.0	3.0	1600	0.56	2750	16000		
C 61 4_521.1			521.1	2.7	1600	0.50	16000	C 61 4_521.1	521.1	2.7	1600	0.50	2780	16000		
C 61 4_571.2			571.2	2.5	1600	0.45	16000	C 61 4_571.2	571.2	2.5	1600	0.45	2800	16000		
C 61 4_610.1			610.1	2.3	1600	0.43	16000	C 61 4_610.1	610.1	2.3	1600	0.43	2810	16000		
C 61 4_668.8			668.8	2.1	1600	0.39	16000	C 61 4_668.8	668.8	2.1	1600	0.39	2830	16000		
C 61 4_726.3	726.3		1.9	1600	0.36	16000	C 61 4_726.3	726.3	1.9	1600	0.36	2840	16000			
C 61 4_796.1	796.1		1.8	1600	0.33	16000	C 61 4_796.1	796.1	1.8	1600	0.33	2860	16000			

46

(*) The values specified refer only to the gearbox output section.

"P" input sections are dimensioned for maximum installable motor power (see the chart for motor availability - page 25)

2.8 MOTOR AVAILABILITY

2.8.1 GEOMETRICAL COMPATIBILITY

Please be aware that motor-gearbox availability resulting from chart below are purely based on geometrical compatibility.



		IEC_  (IM B5)					
		P63 P71	P80 P90	P100 P112	P132	P160	P180
C 12 2	 i =	7.6_66.2	7.6_47.6	7.6_47.6			
C 22 2		9.6_63.3	7.1_54.7	7.1_54.7			
C 22 3		60.0_261.0	60.0_261.0	60.0_261.0			
C 32 2		14.3_66.8	7.2_66.8	7.2_66.8	7.2_25.1		
C 32 3		74.7_274.7	74.7_274.7	74.7_274.7			
C 36 2		11.7_19.0	6.8_19.0	6.8_19.0	6.8_19.0		
C 36 3		38.1_206.4	22.1_206.4	22.1_206.4	22.1_77.6		
C 36 4		230.9_848.5	230.9_848.5	230.9_848.5			
C 41 2		14.2_44.8	6.4_44.8	6.4_44.8	6.4_31.4		
C 41 3		47.0_209.1	28.5_209.1	28.5_209.1	28.5_102.3		
C 41 4		239.9_855.5	239.9_855.5	239.9_855.5			
C 51 2		18.9_57.0	7.0_57.0	7.0_57.0	7.0_40.4	7.0_40.4	7.0_40.4
C 51 3		59.0_216.7	21.8_216.7	21.8_216.7	21.8_124.4	21.8_124.4	21.8_124.4
C 51 4		240.9_884.9	240.9_884.9	240.9_884.9	240.9_508.0		
C 61 2		22.4_38.0	8.8_38.0	8.8_38.0	6.7_38.0	6.7_38.0	6.7_38.0
C 61 3		67.7_195.8	26.8_195.8	26.8_195.8	26.8_140.5	26.8_140.5	26.8_140.5
C 61 4		217.4_796.1	217.4_796.1	217.4_796.1			





2.8.2 MAXIMUM INSTALLABLE POWER

When selecting a gearbox with IEC motor adapter, refer to procedure specified at chapter 1.4

P_{n1} = maximum installable power on the input P_{-}

		 IEC_ (IM B5) - $n_1 = 1400 \text{ min}^{-1}$								
P_{n1} [kW]		0.12	0.18	0.25	0.37	0.55	0.75	1.10	1.50	1.85
		P63	P63	P71	P71	P80	P80	P90	P90	P90
C 12 2	i =	7.6_66.2	7.6_42.3	7.6_29.5	7.6_17.2	7.6_8.8				
C 22 2		9.6_63.3	9.6_63.3	9.6_63.3	9.6_48.6	7.1_36.8	7.1_21.5	7.1_12.4	7.1	
C 22 3		60.0_200.7	60.0_122.2	60.0_88.5	60.0					
C 32 2		12.3_66.8	12.3_66.8	12.3_66.8	12.3_59.4	7.2_52.4	7.2_40.7	7.2_25.1	7.2_15.6	7.2_9.3
C 32 3		74.7_274.7	74.7_186.0	74.7_148.4	74.7_82.6					
C 36 2		11.7_19.0	11.7_19.0	11.7_19.0	11.7_19.0	6.8_19.0	6.8_19.0	6.8_19.0	6.8_19.0	6.8_19.0
C 36 3		38.1_206.4	38.1_206.4	38.1_206.4	38.1_183.5	22.1_111.5	22.1_83.1	22.1_43.5	22.1_26.2	
C 36 4		230.9_574.7	230.9_377.9	230.9_255.0						
C 41 2		14.2_44.8	14.2_44.8	14.2_44.8	14.2_44.8	6.4_44.8	6.4_44.8	6.4_44.8	6.4_33.4	6.4_22.6
C 41 3		51.5_209.1	51.5_209.1	51.5_209.1	28.5_209.1	28.5_164.1 ⊖ (145.6)	28.5_110.1 ⊖ (102.3)	28.5_58.7	28.5_40.3	28.5
C 41 4		239.9_780.4	239.9_493.5	239.9_381.8	239.9					
C 51 2		18.9_57.0	18.9_57.0	18.9_57.0	18.9_57.0	7.0_57.0	7.0_57.0	7.0_57.0	7.0_57.0	7.0_47.8
C 51 3		59.0_216.7	59.0_216.7	59.0_216.7	59.0_216.7	21.8_216.7	21.8_197.9	21.8_134.6	21.8_93.0	21.8_72.9
C 51 4		240.9_884.9	240.9_808.0	240.9_602.0	240.9_415.7	240.9_263.8				
C 61 2		22.4_38.0	22.4_38.0	22.4_38.0	22.4_38.0	8.8_38.0	8.8_38.0	8.8_38.0	8.8_38.0	8.8_38.0
C 61 3		67.7_195.8	67.7_195.8	67.7_195.8	67.7_195.8	26.8_195.8	26.8_195.8	26.8_195.8	26.8_164.5	26.8_128.1
C 61 4	217.4_796.1	217.4_796.1	217.4_796.1	217.4_668.8	217.4_462.0	217.4_337.7	217.4			

		 IEC_ (IM B5) - $n_1 = 1400 \text{ min}^{-1}$									
P_{n1} [kW]		2.20	3.00	4.00	5.50	7.50	9.20	11.00	15.00	18.50	22.00
		P100	P100	P112	P132	P132	P132	P160	P160	P180	P180
C 12 2	i =										
C 22 2											
C 22 3											
C 32 2		7.2_8.5									
C 32 3											
C 36 2		6.8_14.8	6.8_11.7	6.8_8.8							
C 36 3											
C 36 4											
C 41 2		6.4_19.8	6.4_12.4	6.4_7.1							
C 41 3											
C 41 4											
C 51 2		7.0_43.1	7.0_29.8	7.0_23.4	7.0_15.0	7.0_8.8	7.0				
C 51 3		21.8_59.0	21.8_40.5	21.8_23.9							
C 51 4											
C 61 2		8.8_38.0	8.8_38.0	8.8_34.2	6.7_27.4	6.7_22.4 ⊖ (19.6)	6.7_17.7 ⊖ (15.9)	6.7_14.3	6.7_10.9 ⊖ (9.8)	6.7_8.8 ⊖ (7.5)	6.7
C 61 3		26.8_103.6	26.8_67.7	26.8_43.4	26.8_29.4						
C 61 4											

2.9 MOMENT OF INERTIA

The following charts indicate moment of inertia values J_r [kgm²] referred to the gear unit high speed shaft. A key to the symbols used follows:



Values under this symbol re-fer to gearboxes with IEC mo-tor adaptor (IEC size...).

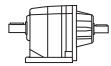

This symbol refers to gearbox values.

C 12

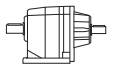
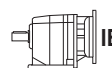
	i	J ($\cdot 10^{-4}$) [kgm ²]						
		 IEC						
		63	71	80	90	100	112	
C 12 2_7.6	7.6	1.8	1.8	3.2	3.1	4.4	4.4	—
C 12 2_8.8	8.8	1.8	1.8	3.2	3.1	4.4	4.4	—
C 12 2_10.1	10.1	1.7	1.7	3.1	3.0	4.3	4.3	—
C 12 2_11.9	11.9	1.6	1.6	3.0	3.0	4.2	4.2	—
C 12 2_13.4	13.4	1.6	1.6	3.0	2.9	4.2	4.2	—
C 12 2_15.4	15.4	1.6	1.6	3.0	2.9	4.2	4.2	—
C 12 2_17.2	17.2	1.6	1.6	2.9	2.9	4.2	4.2	—
C 12 2_18.4	18.4	1.6	1.5	2.9	2.9	4.2	4.2	—
C 12 2_20.6	20.6	1.5	1.5	2.9	2.9	4.2	4.2	—
C 12 2_23.2	23.2	1.5	1.5	2.9	2.9	4.1	4.1	—
C 12 2_25.4	25.4	1.5	1.5	2.9	2.8	4.1	4.1	—
C 12 2_29.5	29.5	1.5	1.5	2.9	2.8	4.1	4.1	—
C 12 2_32.8	32.8	1.5	1.5	2.9	2.8	4.1	4.1	—
C 12 2_37.0	37.0	1.5	1.5	2.9	2.8	4.1	4.1	—
C 12 2_42.3	42.3	1.5	1.5	2.9	2.8	4.1	4.1	—
C 12 2_47.6	47.6	1.5	1.5	2.9	2.8	4.1	4.1	—
C 12 2_55.2	55.2	1.5	1.5	—	—	—	—	—
C 12 2_66.2	66.2	1.5	1.5	—	—	—	—	—

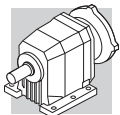

C 22

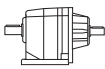
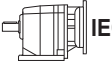
	i	J ($\cdot 10^{-4}$) [kgm ²]						
		 IEC						
		63	71	80	90	100	112	
C 22 2_7.1	7.1	—	—	3.6	3.6	4.8	4.8	2.6
C 22 2_8.7	8.7	—	—	3.4	3.3	4.6	4.6	2.4
C 22 2_9.6	9.6	2.0	2.0	3.3	3.3	4.6	4.6	2.4
C 22 2_11.1	11.1	1.9	1.8	3.2	3.2	4.5	4.5	2.3
C 22 2_12.4	12.4	1.8	1.8	3.2	3.1	4.4	4.4	2.2
C 22 2_14.5	14.5	1.7	1.7	3.1	3.1	4.3	4.3	2.1
C 22 2_15.8	15.8	1.7	1.7	3.1	3.0	4.3	4.3	2.1
C 22 2_18.1	18.1	1.6	1.6	3.0	3.0	4.3	4.3	2.0
C 22 2_20.0	20.0	1.6	1.6	3.0	2.9	4.2	4.2	2.0
C 22 2_21.5	21.5	1.6	1.6	3.0	2.9	4.2	4.2	2.0
C 22 2_24.3	24.3	1.6	1.6	3.0	2.9	4.2	4.2	2.0
C 22 2_27.2	27.2	1.6	1.6	3.0	2.9	4.2	4.2	2.0
C 22 2_29.6	29.6	1.6	1.5	2.9	2.9	4.2	4.2	2.0
C 22 2_33.1	33.1	1.5	1.5	2.9	2.9	4.2	4.2	1.9
C 22 2_36.8	36.8	1.5	1.5	2.9	2.8	4.1	4.1	1.9
C 22 2_43.3	43.3	1.5	1.5	2.9	2.8	4.1	4.1	1.9
C 22 2_48.6	48.6	1.5	1.5	2.9	2.8	4.1	4.1	1.9
C 22 2_54.7	54.7	1.5	1.5	2.9	2.8	4.1	4.1	1.9
C 22 2_63.3	63.3	1.5	1.5	—	—	—	—	1.9
C 22 3_60.0	60.0	1.5	1.5	2.9	2.8	4.1	4.1	—
C 22 3_65.3	65.3	1.5	1.5	2.9	2.8	4.1	4.1	—
C 22 3_74.8	74.8	1.5	1.5	2.9	2.8	4.1	4.1	—
C 22 3_82.6	82.6	1.5	1.5	2.9	2.8	4.1	4.1	—
C 22 3_88.5	88.5	1.5	1.5	2.9	2.8	4.1	4.1	—
C 22 3_100.2	100.2	1.5	1.5	2.9	2.8	4.1	4.1	—
C 22 3_112.0	112.0	1.5	1.5	2.9	2.8	4.1	4.1	—
C 22 3_122.2	122.2	1.5	1.5	2.9	2.8	4.1	4.1	—
C 22 3_136.5	136.5	1.5	1.5	2.9	2.8	4.1	4.1	—
C 22 3_151.7	151.7	1.5	1.5	2.9	2.8	4.1	4.1	—
C 22 3_178.5	178.5	1.5	1.5	2.9	2.8	4.1	4.1	—
C 22 3_200.7	200.7	1.5	1.5	2.9	2.8	4.1	4.1	—
C 22 3_225.8	225.8	1.5	1.5	2.9	2.8	4.1	4.1	—
C 22 3_261.0	261.0	1.5	1.5	2.9	2.8	4.1	4.1	—

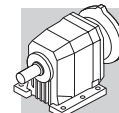

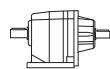
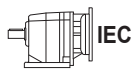

C 32

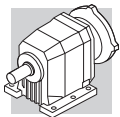
	i	J (•10 ⁻⁴) [kgm ²]							
									
		63	71	80	90	100	112	132	
C 32 2_7.2	7.2	—	—	4.4	4.3	5.6	5.6	19	3.7
C 32 2_8.5	8.5	—	—	4.1	4.0	5.3	5.3	19	3.4
C 32 2_9.3	9.3	—	—	3.9	3.9	5.1	5.1	19	3.3
C 32 2_11.2	11.2	—	—	3.7	3.6	4.9	4.9	19	3.0
C 32 2_12.3	12.3	2.1	2.1	3.4	3.4	4.7	4.7	18	2.8
C 32 2_14.1	14.1	2.1	2.1	3.5	3.4	4.7	4.7	18	2.8
C 32 2_15.6	15.6	1.9	1.9	3.3	3.2	4.5	4.5	18	2.7
C 32 2_18.2	18.2	1.9	1.9	3.3	3.2	4.5	4.5	18	2.6
C 32 2_20.1	20.1	1.8	1.8	3.2	3.1	4.4	4.4	18	2.6
C 32 2_22.9	22.9	1.8	1.8	3.2	3.1	4.4	4.4	17	2.5
C 32 2_25.1	25.1	1.7	1.7	3.1	3.0	4.3	4.3	17	2.5
C 32 2_26.9	26.9	1.7	1.7	3.1	3.0	4.3	4.3	—	2.5
C 32 2_29.8	29.8	1.7	1.7	3.0	3.0	4.3	4.3	—	2.4
C 32 2_33.1	33.1	1.7	1.7	3.0	3.0	4.3	4.3	—	2.4
C 32 2_36.1	36.1	1.6	1.6	3.0	2.9	4.2	4.2	—	2.4
C 32 2_40.7	40.7	1.6	1.6	3.0	2.9	4.2	4.2	—	2.4
C 32 2_45.3	45.3	1.6	1.6	3.0	2.9	4.2	4.2	—	2.3
C 32 2_52.4	52.4	1.6	1.6	2.9	2.9	4.2	4.2	—	2.3
C 32 2_59.4	59.4	1.5	1.5	2.9	2.9	4.2	4.2	—	2.3
C 32 2_66.8	66.8	1.5	1.5	2.9	2.8	4.1	4.1	—	2.3
C 32 3_74.7	74.7	1.5	1.5	2.9	2.9	4.1	4.1	—	—
C 32 3_82.6	82.6	1.5	1.5	2.9	2.8	4.1	4.1	—	—
C 32 3_94.2	94.2	1.5	1.5	2.9	2.8	4.1	4.1	—	—
C 32 3_103.3	103.3	1.5	1.5	2.9	2.8	4.1	4.1	—	—
C 32 3_110.6	110.6	1.5	1.5	2.9	2.8	4.1	4.1	—	—
C 32 3_122.4	122.4	1.5	1.5	2.9	2.8	4.1	4.1	—	—
C 32 3_136.0	136.0	1.5	1.5	2.9	2.8	4.1	4.1	—	—
C 32 3_148.4	148.4	1.5	1.5	2.9	2.8	4.1	4.1	—	—
C 32 3_167.4	167.4	1.5	1.5	2.9	2.8	4.1	4.1	—	—
C 32 3_186.0	186.0	1.5	1.5	2.9	2.8	4.1	4.1	—	—
C 32 3_215.6	215.6	1.5	1.5	2.9	2.8	4.1	4.1	—	—
C 32 3_244.2	244.2	1.5	1.5	2.9	2.8	4.1	4.1	—	—
C 32 3_274.7	274.7	1.5	1.5	2.9	2.8	4.1	4.1	—	—



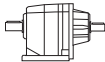

C 36

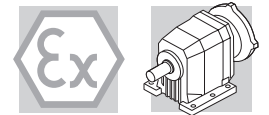
	i	J ($\cdot 10^{-4}$) [kgm ²]							
		 IEC							
		63	71	80	90	100	112	132	
C 36 2_6.8	6.8	—	—	5.1	5.0	6.3	6.3	20	13
C 36 2_8.0	8.0	—	—	4.4	4.3	5.6	5.6	20	12
C 36 2_8.8	8.8	—	—	4.4	4.3	5.6	5.6	19	12
C 36 2_10.6	10.6	—	—	3.9	3.8	5.1	5.1	19	12
C 36 2_11.7	11.7	2.5	2.5	3.9	3.8	5.1	5.1	19	12
C 36 2_13.3	13.3	2.2	2.2	3.6	3.5	4.8	4.8	19	11
C 36 2_14.8	14.8	2.2	2.2	3.6	3.5	4.8	4.8	19	11
C 36 2_17.2	17.2	2.0	2.0	3.4	3.3	4.6	4.6	18	11
C 36 2_19.0	19.0	2.0	2.0	3.4	3.3	4.6	4.6	18	11
C 36 3_22.1	22.1	—	—	4.7	4.6	5.9	5.9	19	12
C 36 3_26.2	26.2	—	—	4.2	4.1	5.4	5.4	19	12
C 36 3_28.7	28.7	—	—	4.2	4.1	5.4	5.4	19	12
C 36 3_34.6	34.6	—	—	3.8	3.7	5.0	5.0	19	11
C 36 3_38.1	38.1	2.4	2.4	3.8	3.7	5.0	5.0	19	11
C 36 3_43.5	43.5	2.1	2.1	3.5	3.4	4.7	4.7	19	11
C 36 3_48.2	48.2	2.1	2.1	3.5	3.4	4.7	4.7	19	11
C 36 3_56.2	56.2	1.9	1.9	3.3	3.2	4.5	4.5	18	11
C 36 3_62.0	62.0	1.9	1.9	3.3	3.2	4.5	4.5	18	11
C 36 3_70.8	70.8	1.8	1.8	3.2	3.1	4.4	4.4	18	11
C 36 3_77.6	77.6	1.8	1.8	3.2	3.1	4.4	4.4	17	11
C 36 3_83.1	83.1	1.7	1.7	3.1	3.0	4.3	4.3	—	11
C 36 3_91.9	91.9	1.7	1.7	3.1	3.0	4.3	4.3	—	11
C 36 3_102.2	102.2	1.7	1.7	3.1	3.0	4.3	4.3	—	11
C 36 3_111.5	111.5	1.7	1.7	3.1	3.0	4.3	4.3	—	11
C 36 3_125.8	125.8	1.6	1.6	3.0	2.9	4.2	4.2	—	11
C 36 3_139.8	139.8	1.6	1.6	3.0	2.9	4.2	4.2	—	11
C 36 3_162.0	162.0	1.6	1.6	3.0	2.9	4.2	4.2	—	11
C 36 3_183.5	183.5	1.6	1.6	3.0	2.9	4.2	4.2	—	11
C 36 3_206.4	206.4	1.6	1.6	3.0	2.9	4.2	4.2	—	11
C 36 4_230.9	230.9	—	—	—	—	—	—	—	—
C 36 4_255.0	255.0	1.6	1.6	3.0	2.9	4.2	4.2	—	—
C 36 4_290.9	290.9	1.6	1.6	3.0	2.9	4.2	4.2	—	—
C 36 4_318.9	318.9	1.6	1.6	3.0	2.9	4.2	4.2	—	—
C 36 4_341.7	341.7	1.6	1.6	3.0	2.9	4.2	4.2	—	—
C 36 4_377.9	377.9	1.6	1.6	3.0	2.9	4.2	4.2	—	—
C 36 4_420.2	420.2	1.6	1.6	3.0	2.9	4.2	4.2	—	—
C 36 4_458.4	458.4	1.6	1.6	3.0	2.9	4.2	4.2	—	—
C 36 4_517.2	517.2	1.6	1.6	3.0	2.9	4.2	4.2	—	—
C 36 4_574.7	574.7	1.6	1.6	3.0	2.9	4.2	4.2	—	—
C 36 4_665.9	665.9	1.6	1.6	3.0	2.9	4.2	4.2	—	—
C 36 4_754.2	754.2	1.6	1.6	3.0	2.9	4.2	4.2	—	—
C 36 4_848.5	848.5	1.6	1.6	3.0	2.9	4.2	4.2	—	—



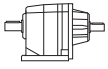

C 41

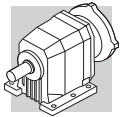
	i	J (•10 ⁻⁴) [kgm ²]							
		 IEC							
		63	71	80	90	100	112	132	
C 41 2_6.4	6.4	—	—	7.2	7.1	8.4	8.4	23	15
C 41 2_7.1	7.1	—	—	7.0	6.9	8.2	8.2	23	15
C 41 2_8.6	8.6	—	—	5.8	5.7	7.0	7.0	22	13
C 41 2_9.6	9.6	—	—	5.7	5.6	6.9	6.9	22	13
C 41 2_11.2	11.2	—	—	4.7	4.6	5.9	5.9	21	12
C 41 2_12.4	12.4	—	—	4.7	4.6	5.9	5.9	21	12
C 41 2_14.2	14.2	2.9	2.9	4.3	4.2	5.5	5.5	20	12
C 41 2_15.8	15.8	2.8	2.8	4.2	4.1	5.4	5.4	20	12
C 41 2_17.8	17.8	2.5	2.5	3.9	3.8	5.1	5.1	20	12
C 41 2_19.8	19.8	2.5	2.5	3.9	3.8	5.1	5.1	20	12
C 41 2_22.6	22.6	2.1	2.1	3.5	3.4	4.7	4.7	20	11
C 41 2_25.0	25.0	2.1	2.1	3.5	3.4	4.7	4.7	20	11
C 41 2_28.3	28.3	1.9	1.9	3.3	3.2	4.5	4.5	19	11
C 41 2_31.4	31.4	1.9	1.9	3.3	3.2	4.5	4.5	19	11
C 41 2_33.4	33.4	1.8	1.8	3.2	3.1	4.4	4.4	—	11
C 41 2_37.1	37.1	1.8	1.8	3.2	3.1	4.4	4.4	—	11
C 41 2_44.8	44.8	1.8	1.8	3.2	3.1	4.4	4.4	—	11
C 41 3_28.5	28.5	—	—	5.4	5.3	6.6	6.6	21	13
C 41 3_31.2	31.2	—	—	5.4	5.3	6.6	6.6	21	13
C 41 3_36.8	36.8	—	—	4.5	4.4	5.7	5.7	21	12
C 41 3_40.3	40.3	—	—	4.5	4.4	5.7	5.7	21	12
C 41 3_47.0	47.0	2.7	2.7	4.1	4.0	5.3	5.3	20	12
C 41 3_51.5	51.5	2.7	2.7	4.1	4.0	5.3	5.3	20	12
C 41 3_58.7	58.7	2.4	2.4	3.8	3.7	5.0	5.0	20	11
C 41 3_64.3	64.3	2.4	2.4	3.8	3.7	5.0	5.0	20	11
C 41 3_74.4	74.4	2.1	2.1	3.5	3.4	4.7	4.7	20	11
C 41 3_81.5	81.5	2.1	2.1	3.5	3.4	4.7	4.7	20	11
C 41 3_93.9	93.9	1.9	1.9	3.3	3.2	4.5	4.5	19	11
C 41 3_102.3	102.3	1.9	1.9	3.3	3.2	4.5	4.5	19	11
C 41 3_110.1	110.1	1.8	1.8	3.2	3.1	4.4	4.4	—	11
C 41 3_120.6	120.6	1.8	1.8	3.2	3.1	4.4	4.4	—	11
C 41 3_132.9	132.9	1.8	1.8	3.2	3.1	4.4	4.4	—	11
C 41 3_145.6	145.6	1.8	1.8	3.2	3.1	4.4	4.4	—	11
C 41 3_164.1	164.1	1.7	1.7	3.1	3.0	4.3	4.3	—	11
C 41 3_179.9	179.9	1.7	1.7	3.1	3.0	4.3	4.3	—	11
C 41 3_190.8	190.8	1.6	1.6	3.0	2.9	4.2	4.2	—	11
C 41 3_209.1	209.1	1.6	1.6	3.0	2.9	4.2	4.2	—	11
C 41 4_239.9	239.9	1.7	1.7	3.1	3.0	4.3	4.3	—	2.1
C 41 4_263.0	263.0	1.7	1.7	3.1	3.0	4.3	4.3	—	2.1
C 41 4_304.2	304.2	1.6	1.6	3.0	2.9	4.2	4.2	—	2.0
C 41 4_333.4	333.4	1.6	1.6	3.0	2.9	4.2	4.2	—	2.0
C 41 4_382.0	382.0	1.6	1.6	3.0	2.9	4.2	4.2	—	2.0
C 41 4_419.0	419.0	1.6	1.6	3.0	2.9	4.2	4.2	—	2.0
C 41 4_450.2	450.2	1.6	1.6	3.0	2.9	4.2	4.2	—	2.0
C 41 4_493.5	493.5	1.6	1.6	3.0	2.9	4.2	4.2	—	2.0
C 41 4_543.5	543.5	1.6	1.6	3.0	2.9	4.2	4.2	—	2.0
C 41 4_595.8	595.8	1.6	1.6	3.0	2.9	4.2	4.2	—	2.0
C 41 4_671.3	671.3	1.6	1.6	3.0	2.9	4.2	4.2	—	2.0
C 41 4_735.9	735.9	1.6	1.6	3.0	2.9	4.2	4.2	—	2.0
C 41 4_780.4	780.4	1.6	1.6	3.0	2.9	4.2	4.2	—	2.0
C 41 4_855.5	855.5	1.6	1.6	3.0	2.9	4.2	4.2	—	2.0



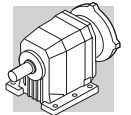

C 51

	i	J ($\cdot 10^{-4}$) [kgm ²]									
		 IEC									
		63	71	80	90	100	112	132	160	180	
C 51 2_7.0	7.0	—	—	11	11	12	12	27	73	70	19
C 51 2_7.8	7.8	—	—	11	11	12	12	27	73	70	18
C 51 2_8.8	8.8	—	—	8.9	8.8	10	10	25	71	68	17
C 51 2_9.8	9.8	—	—	8.7	8.6	9.9	9.9	25	71	68	16
C 51 2_11.8	11.8	—	—	7.0	6.9	8.2	8.2	23	69	66	15
C 51 2_13.1	13.1	—	—	6.9	6.8	8.1	8.1	23	69	66	15
C 51 2_15.0	15.0	—	—	5.6	5.5	6.8	6.8	22	68	65	13
C 51 2_16.6	16.6	—	—	5.5	5.4	6.7	6.7	22	68	65	13
C 51 2_18.9	18.9	3.5	3.5	4.9	4.8	6.1	6.1	21	67	64	13
C 51 2_21.0	21.0	3.4	3.4	4.8	4.7	6.0	6.0	21	67	64	12
C 51 2_23.4	23.4	3.0	3.0	4.4	4.3	5.6	5.6	20	66	63	12
C 51 2_25.9	25.9	2.9	2.9	4.3	4.2	5.5	5.5	20	66	63	12
C 51 2_29.8	29.8	2.4	2.4	3.8	3.7	5.0	5.0	20	66	63	11
C 51 2_33.0	33.0	2.4	2.4	3.8	3.7	5.0	5.0	20	66	63	11
C 51 2_36.4	36.4	2.2	2.2	3.6	3.5	4.8	4.8	20	66	63	11
C 51 2_40.4	40.4	2.2	2.2	3.6	3.5	4.8	4.8	20	66	63	11
C 51 2_43.1	43.1	2.0	2.0	3.4	3.3	4.6	4.6	—	—	—	11
C 51 2_47.8	47.8	2.0	2.0	3.4	3.3	4.6	4.6	—	—	—	11
C 51 2_51.4	51.4	1.9	1.9	3.3	3.2	4.5	4.5	—	—	—	11
C 51 2_57.0	57.0	1.9	1.9	3.3	3.2	4.5	4.5	—	—	—	11
C 51 3_21.8	21.8	—	—	9.7	9.6	11	11	26	72	69	17
C 51 3_23.9	23.9	—	—	9.7	9.6	11	11	26	72	69	17
C 51 3_27.4	27.4	—	—	8.1	8.0	9.3	9.3	24	70	67	16
C 51 3_30.1	30.1	—	—	8.1	8.0	9.3	9.3	24	70	67	16
C 51 3_37.0	37.0	—	—	6.5	6.4	7.7	7.7	23	69	66	14
C 51 3_40.5	40.5	—	—	6.5	6.4	7.7	7.7	23	69	66	14
C 51 3_46.7	46.7	—	—	5.3	5.2	6.5	6.5	21	67	64	13
C 51 3_51.2	51.2	—	—	5.3	5.2	6.5	6.5	21	67	64	13
C 51 3_59.0	59.0	3.3	3.3	4.7	4.6	5.9	5.9	21	67	64	12
C 51 3_64.6	64.6	3.3	3.3	4.7	4.6	5.9	5.9	21	67	64	12
C 51 3_72.9	72.9	2.8	2.8	4.2	4.1	5.4	5.4	20	66	63	12
C 51 3_79.9	79.9	2.8	2.8	4.2	4.1	5.4	5.4	20	66	63	12
C 51 3_93.0	93.0	2.3	2.3	3.7	3.6	4.9	4.9	20	66	63	11
C 51 3_101.8	101.8	2.3	2.3	3.7	3.6	4.9	4.9	20	66	63	11
C 51 3_113.6	113.6	2.1	2.1	3.5	3.4	4.7	4.7	20	66	63	11
C 51 3_124.4	124.4	2.1	2.1	3.5	3.4	4.7	4.7	20	66	63	11
C 51 3_134.6	134.6	2.0	2.0	3.4	3.3	4.6	4.6	—	—	—	11
C 51 3_147.4	147.4	2.0	2.0	3.4	3.3	4.6	4.6	—	—	—	11
C 51 3_160.5	160.5	1.9	1.9	3.3	3.2	4.5	4.5	—	—	—	11
C 51 3_175.8	175.8	1.9	1.9	3.3	3.2	4.5	4.5	—	—	—	11
C 51 3_197.9	197.9	1.8	1.8	3.2	3.1	4.4	4.4	—	—	—	11
C 51 3_216.7	216.7	1.8	1.8	3.2	3.1	4.4	4.4	—	—	—	11
C 51 4_240.9	240.9	1.8	1.8	3.2	3.1	4.4	4.4	17	—	—	1.2
C 51 4_263.8	263.8	1.8	1.8	3.2	3.1	4.4	4.4	17	—	—	1.2
C 51 4_297.8	297.8	1.8	1.8	3.2	3.1	4.4	4.4	17	—	—	1.2
C 51 4_326.1	326.1	1.8	1.8	3.2	3.1	4.4	4.4	17	—	—	1.2
C 51 4_380.0	380.0	1.7	1.7	3.1	3.0	4.3	4.3	17	—	—	1.1
C 51 4_416.0	416.0	1.7	1.7	3.1	3.0	4.3	4.3	17	—	—	1.1
C 51 4_463.9	463.9	1.7	1.7	3.1	3.0	4.3	4.3	17	—	—	1.1
C 51 4_508.0	508.0	1.7	1.7	3.1	3.0	4.3	4.3	17	—	—	1.1
C 51 4_549.7	549.7	1.7	1.7	3.1	3.0	4.3	4.3	—	—	—	1.1
C 51 4_602.0	602.0	1.7	1.7	3.1	3.0	4.3	4.3	—	—	—	1.1
C 51 4_655.4	655.4	1.7	1.7	3.1	3.0	4.3	4.3	—	—	—	1.1
C 51 4_717.7	717.7	1.7	1.7	3.1	3.0	4.3	4.3	—	—	—	1.1
C 51 4_808.0	808.0	1.7	1.7	3.1	3.0	4.3	4.3	—	—	—	1.1
C 51 4_884.9	884.9	1.7	1.7	3.1	3.0	4.3	4.3	—	—	—	1.1

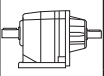

C 61

	i	J ($\cdot 10^{-4}$) [kgm ²]									
		 IEC									
		63	71	80	90	100	112	132	160	180	
C 61 2_6.7	6.7	—	—	—	—	—	—	33	78	76	36
C 61 2_7.5	7.5	—	—	—	—	—	—	32	78	76	35
C 61 2_8.8	8.8	—	—	16	16	17	17	32	78	76	35
C 61 2_9.8	9.8	—	—	15	15	16	16	31	78	76	34
C 61 2_10.9	10.9	—	—	13	12	14	14	29	78	76	31
C 61 2_12.1	12.1	—	—	12	12	13	13	28	78	76	31
C 61 2_14.3	14.3	—	—	8.7	8.6	9.9	9.9	25	78	76	28
C 61 2_15.9	15.9	—	—	8.5	8.4	9.7	9.7	25	78	76	27
C 61 2_17.7	17.7	—	—	7.3	7.2	8.5	8.5	23	78	76	26
C 61 2_19.6	19.6	—	—	7.2	7.1	8.4	8.4	23	78	76	26
C 61 2_22.4	22.4	4.7	4.7	6.1	6.0	7.3	7.3	22	78	76	25
C 61 2_24.8	24.8	4.6	4.6	6.0	5.9	7.2	7.2	22	78	76	25
C 61 2_27.4	27.4	3.6	3.6	5.0	4.9	6.2	6.2	21	78	76	24
C 61 2_30.4	30.4	3.7	3.7	5.1	5.0	6.3	6.3	21	78	76	24
C 61 2_34.2	34.2	3.0	3.0	4.4	4.3	5.6	5.6	20	78	76	23
C 61 2_38.0	38.0	3.0	3.0	4.4	4.3	5.6	5.6	20	78	76	23
C 61 3_26.8	26.8	—	—	13	13	14	14	29	78	76	32
C 61 3_29.4	29.4	—	—	13	13	14	14	29	78	76	32
C 61 3_33.0	33.0	—	—	11	11	12	12	27	78	76	30
C 61 3_36.1	36.1	—	—	11	11	12	12	27	78	76	30
C 61 3_43.4	43.4	—	—	7.9	7.8	9.1	9.1	24	78	76	27
C 61 3_47.6	47.6	—	—	7.9	7.8	9.1	9.1	24	78	76	27
C 61 3_53.5	53.5	—	—	6.8	6.7	8.0	8.0	23	78	76	26
C 61 3_58.6	58.6	—	—	6.7	6.6	7.9	7.9	23	78	76	26
C 61 3_67.7	67.7	4.3	4.3	5.7	5.6	6.9	6.9	22	78	76	25
C 61 3_74.2	74.2	4.3	4.3	5.7	5.6	6.9	6.9	22	78	76	25
C 61 3_83.0	83.0	3.4	3.4	4.8	4.7	6.0	6.0	21	78	76	24
C 61 3_91.0	91.0	3.4	3.4	4.8	4.7	6.0	6.0	21	78	76	24
C 61 3_103.6	103.6	2.8	2.8	4.2	4.1	5.4	5.4	20	78	76	23
C 61 3_113.6	113.6	2.8	2.8	4.2	4.1	5.4	5.4	20	78	76	23
C 61 3_128.1	128.1	2.5	2.5	3.9	3.8	5.1	5.1	20	78	76	23
C 61 3_140.5	140.5	2.5	2.5	3.9	3.8	5.1	5.1	20	78	76	23
C 61 3_150.0	150.0	2.2	2.2	3.6	3.5	4.8	4.8	—	—	—	23
C 61 3_164.5	164.5	2.2	2.2	3.6	3.5	4.8	4.8	—	—	—	23
C 61 3_178.6	178.6	2.1	2.1	3.5	3.4	4.7	4.7	—	—	—	22
C 61 3_195.8	195.8	2.1	2.1	3.5	3.4	4.7	4.7	—	—	—	22
C 61 4_217.4	217.4	2.2	2.2	3.6	3.5	4.8	4.8	—	—	—	11
C 61 4_238.3	238.3	2.2	2.2	3.6	3.5	4.8	4.8	—	—	—	11
C 61 4_275.3	275.3	2.3	2.3	3.7	3.6	4.9	4.9	—	—	—	11
C 61 4_301.7	301.7	2.3	2.3	3.7	3.6	4.9	4.9	—	—	—	11
C 61 4_337.7	337.7	2.1	2.1	3.5	3.4	4.7	4.7	—	—	—	11
C 61 4_370.1	370.1	2.1	2.1	3.5	3.4	4.7	4.7	—	—	—	11
C 61 4_421.5	421.5	2.0	2.0	3.4	3.3	4.6	4.6	—	—	—	11
C 61 4_462.0	462.0	2.0	2.0	3.4	3.3	4.6	4.6	—	—	—	11
C 61 4_521.1	521.1	2.0	2.0	3.4	3.3	4.6	4.6	—	—	—	11
C 61 4_571.2	571.2	2.0	2.0	3.4	3.3	4.6	4.6	—	—	—	11
C 61 4_610.1	610.1	2.0	2.0	3.4	3.3	4.6	4.6	—	—	—	11
C 61 4_668.8	668.8	2.0	2.0	3.4	3.3	4.6	4.6	—	—	—	11
C 61 4_726.3	726.3	2.0	2.0	3.4	3.3	4.6	4.6	—	—	—	11
C 61 4_796.1	796.1	2.0	2.0	3.4	3.3	4.6	4.6	—	—	—	11

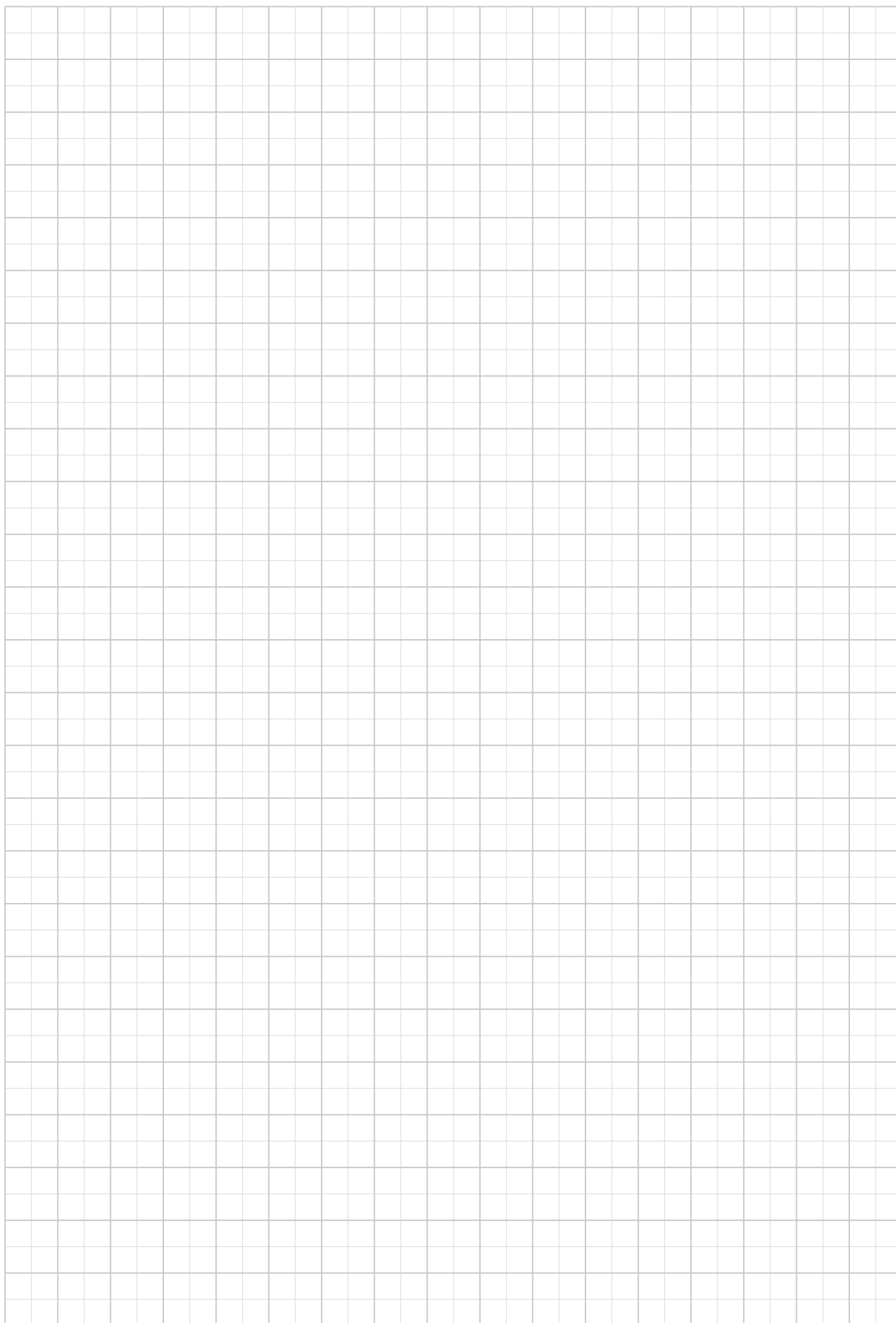
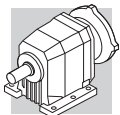

2.10 DIMENSIONS

C 12...P (IEC)

P

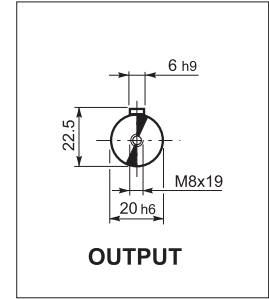
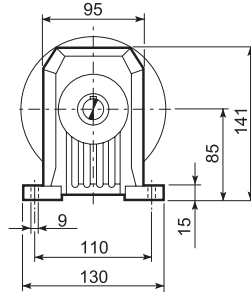
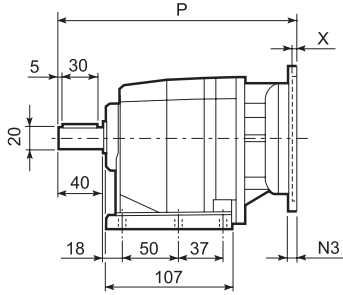

F

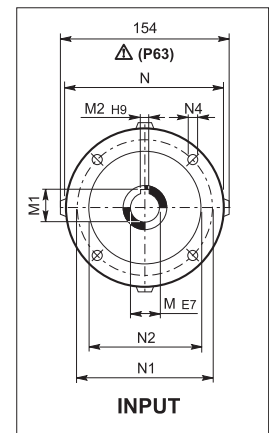
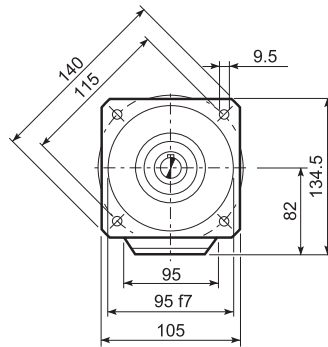
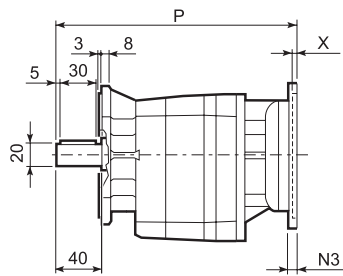

U

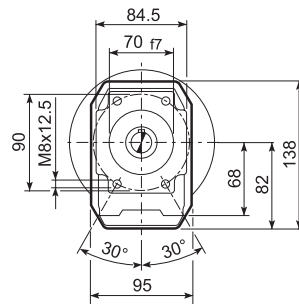
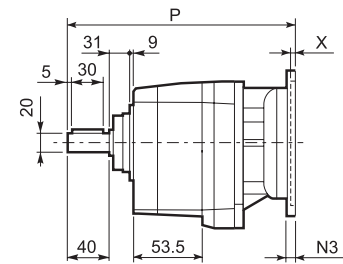

UF

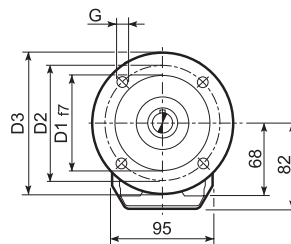
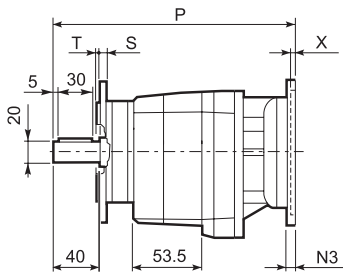

C 12 2 U

	D1	D2	D3	G	T	S
FA	80	100	120	7	3	8
FB	95	115	140	9	3	10
FC	110	130	160	9	3	10

		M	M1	M2	N	N1	N2	N3	N4	X	P	Kg
C 12 2	P63	11	12.8	4	140	115	95	—	M8x19	4	244.5	6
C 12 2	P71	14	16.3	5	160	130	110	—	M8x16	4.5	244.5	6
C 12 2	P80	19	21.8	6	200	165	130	—	M10x12	4	264	7
C 12 2	P90	24	27.3	8	200	165	130	—	M10x12	4	264	7
C 12 2	P100	28	31.3	8	250	215	180	—	M12x16	4.5	274	11
C 12 2	P112	28	31.3	8	250	215	180	—	M12x16	4.5	274	11

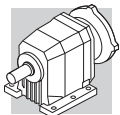

C 22...P(IEC)

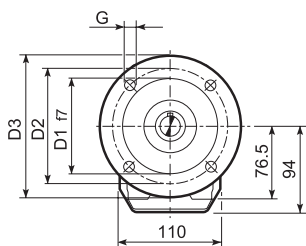
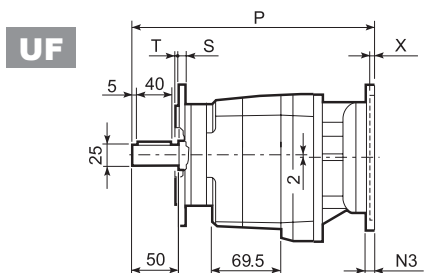
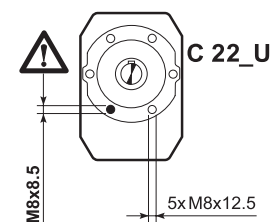
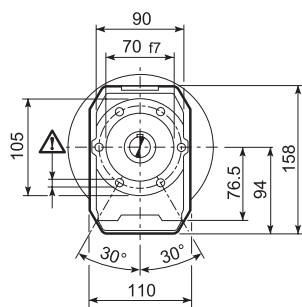
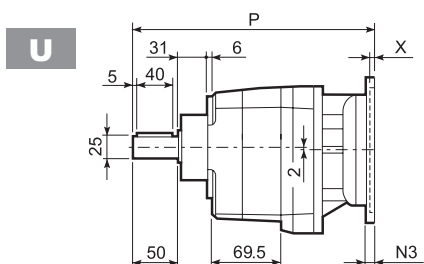
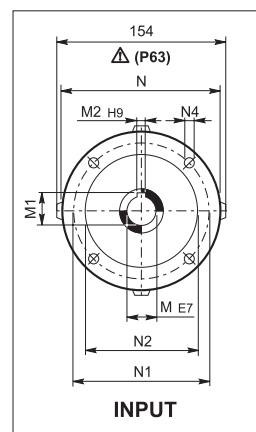
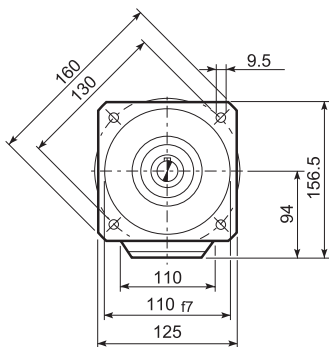
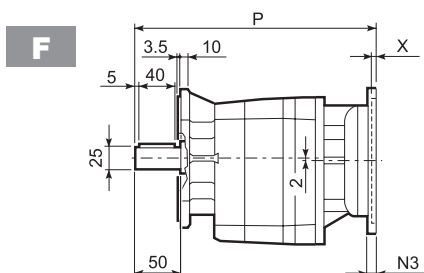
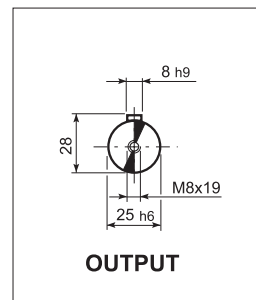
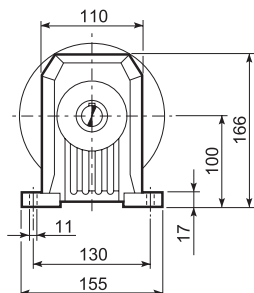
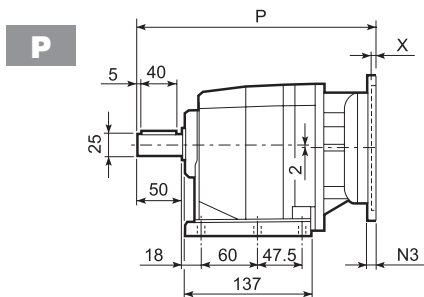

C 22_U						
	D1	D2	D3	G	T	S
FA	95	115	140	9	3	10
FB	110	130	160	9	3	10
FC	130	165	200	11	3.5	11

		M	M1	M2	N	N1	N2	N3	N4	X	P	
C 22 2	P63	11	12.8	4	140	115	95	—	M8x19	4	273	7
C 22 2	P71	14	16.3	5	160	130	110	—	M8x16	4.5	273	7
C 22 2	P80	19	21.8	6	200	165	130	—	M10x12	4	292.5	8
C 22 2	P90	24	27.3	8	200	165	130	—	M10x12	4	292.5	8
C 22 2	P100	28	31.3	8	250	215	180	—	M12x16	4.5	302.5	12
C 22 2	P112	28	31.3	8	250	215	180	—	M12x16	4.5	302.5	12
C 22 3	P63	11	12.8	4	140	115	95	—	M8x19	4	328.5	8
C 22 3	P71	14	16.3	5	160	130	110	—	M8x16	4.5	328.5	8
C 22 3	P80	19	21.8	6	200	165	130	—	M10x12	4	348	9
C 22 3	P90	24	27.3	8	200	165	130	—	M10x12	4	348	9
C 22 3	P100	28	31.3	8	250	215	180	—	M12x16	4.5	358	13
C 22 3	P112	28	31.3	8	250	215	180	—	M12x16	4.5	358	13

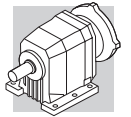

C 22...HS

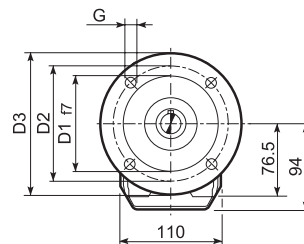
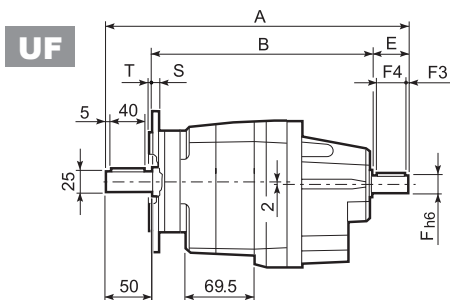
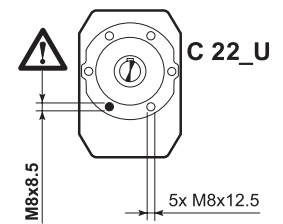
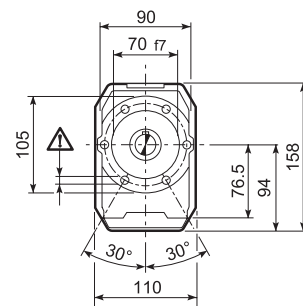
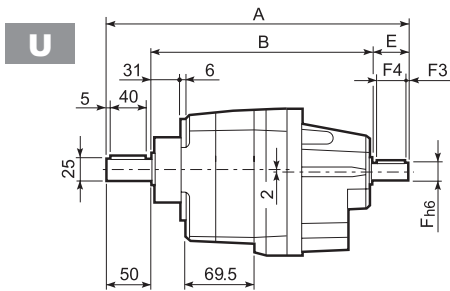
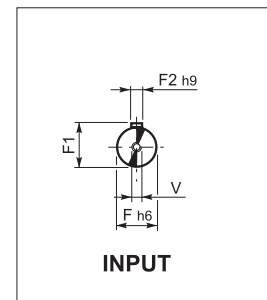
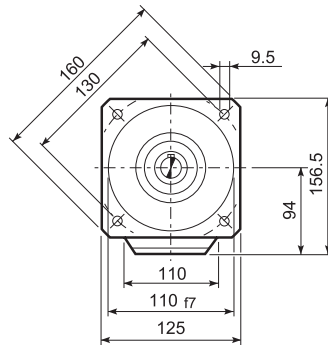
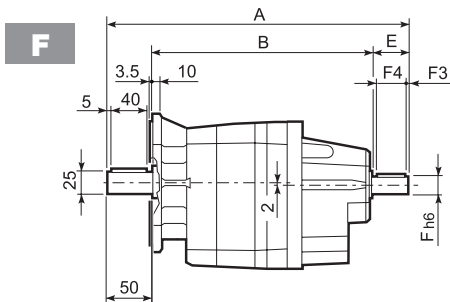
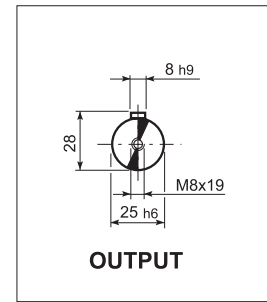
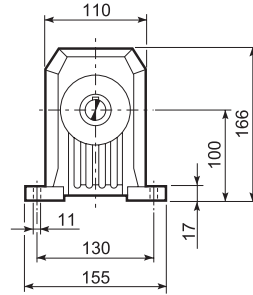
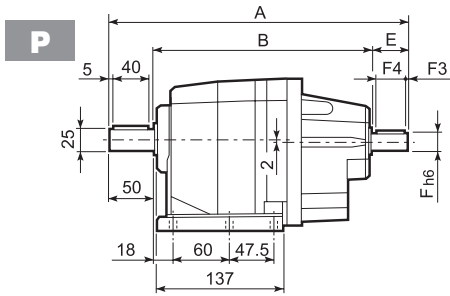

C 22_U						
	D1	D2	D3	G	T	S
FA	95	115	140	9	3	10
FB	110	130	160	9	3	10
FC	130	165	200	11	3.5	11

		A	B	E	F	F1	F2	F3	F4	V	Kg
C 22 2	HS	323	233	40	19	21.5	6	2.5	35	M6x16	7.2

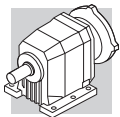

C 32...P(IEC)

P

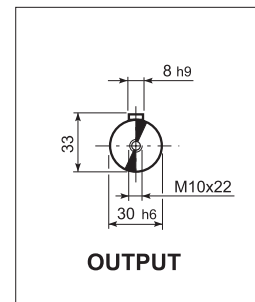
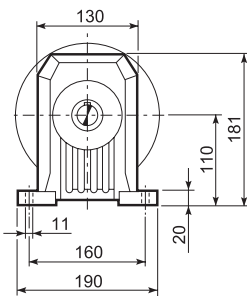
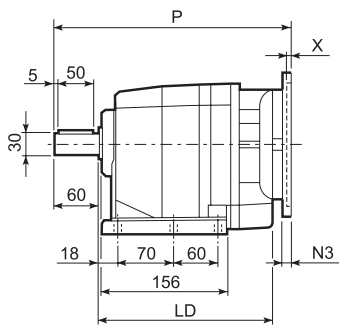

F

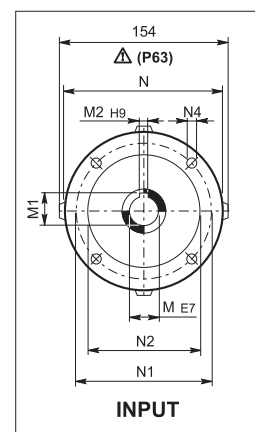
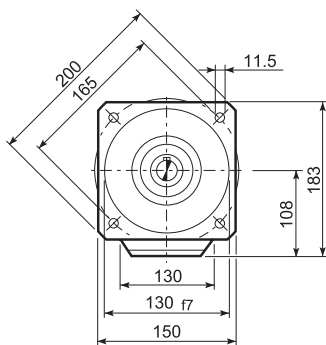
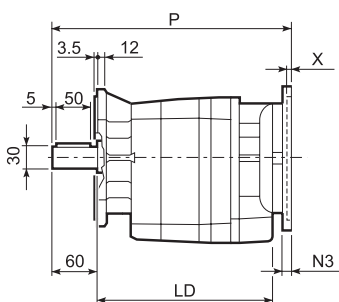

U

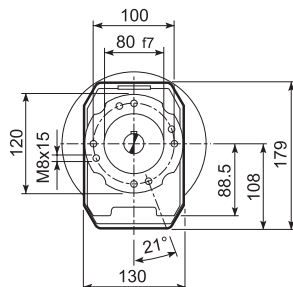
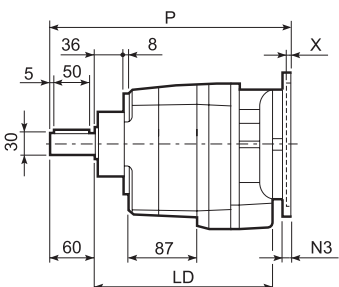

UF

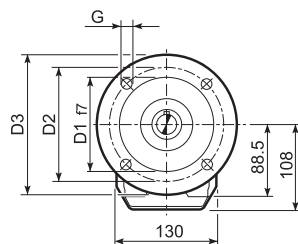
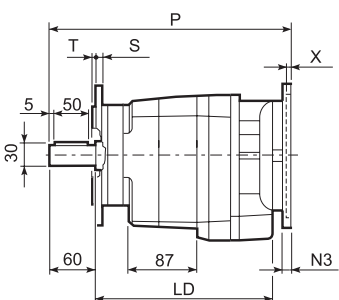

C 32_U						
	D1	D2	D3	G	T	S
FA	110	130	160	9	3	10
FB	130	165	200	11	3.5	11
FC	180	215	250	14	4	13

		LD	M	M1	M2	N	N1	N2	N3	N4	X	P	
C 32 2	P63	217.5	11	12.8	4	140	115	95	—	M8x19	4	307.5	9
C 32 2	P71	217.5	14	16.3	5	160	130	110	—	M8x16	4.5	307.5	9
C 32 2	P80	227.5	19	21.8	6	200	165	130	—	M10x12	4	327	10
C 32 2	P90	227.5	24	27.3	8	200	165	130	—	M10x12	4	327	10
C 32 2	P100	227.5	28	31.3	8	250	215	180	—	M12x16	4.5	337	14
C 32 2	P112	227.5	28	31.3	8	250	215	180	—	M12x16	4.5	337	14
C 32 2	P132	—	38	41.3	10	300	265	230	16	14	5	373	17
C 32 3	P63	—	11	12.8	4	140	115	95	—	M8x19	4	365	10
C 32 3	P71	—	14	16.3	5	160	130	110	—	M8x16	4.5	365	10
C 32 3	P80	—	19	21.8	6	200	165	130	—	M10x12	4	384.5	11
C 32 3	P90	—	24	27.3	8	200	165	130	—	M10x12	4	384.5	11
C 32 3	P100	—	28	31.3	8	250	215	180	—	M12x16	4.5	394.5	15
C 32 3	P112	—	28	31.3	8	250	215	180	—	M12x16	4.5	394.5	15

C 32...HS

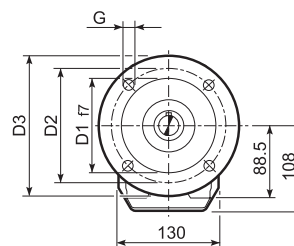
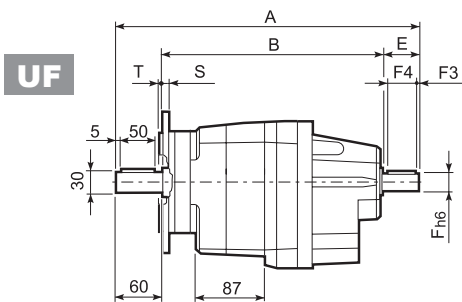
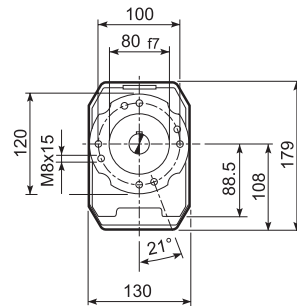
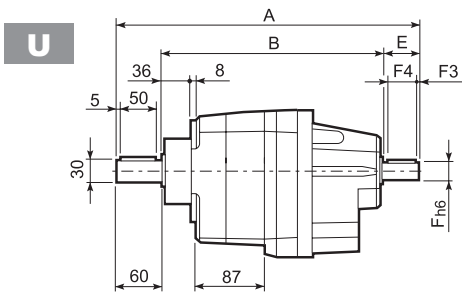
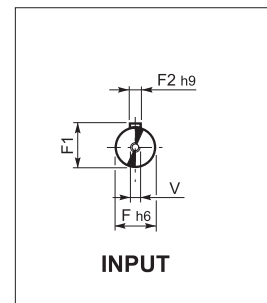
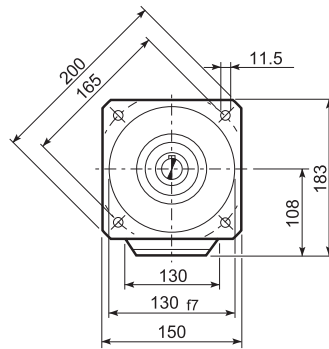
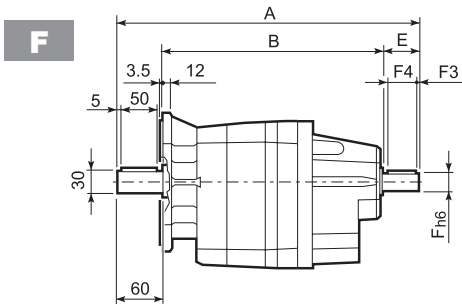
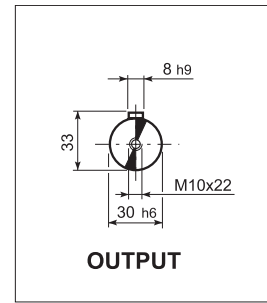
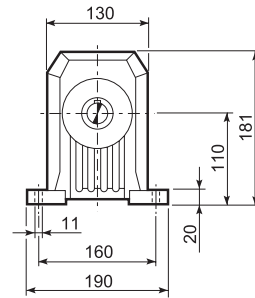
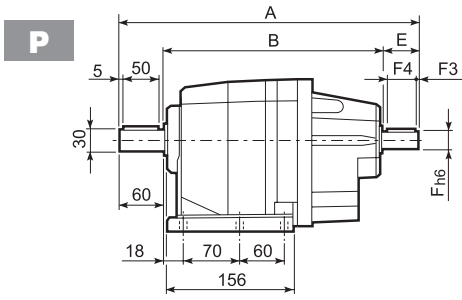

C 32_U						
	D1	D2	D3	G	T	S
FA	110	130	160	9	3	10
FB	130	165	200	11	3.5	11
FC	180	215	250	14	4	13

			A	B	E	F	F1	F2	F3	F4	V	
C 32 2	HS		357.5	257.5	40	19	21.5	6	2.5	35	M6x16	11.1

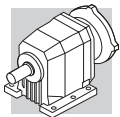

C 36...P(IEC)

P

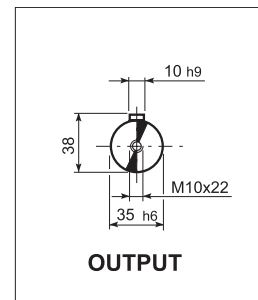
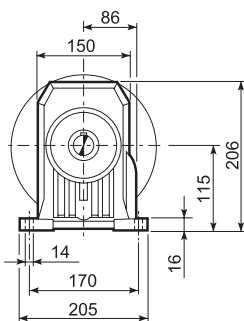
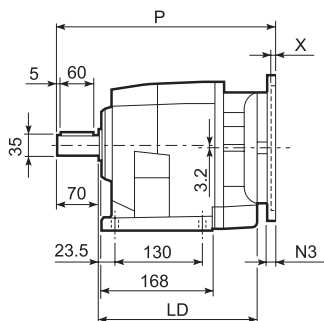

U

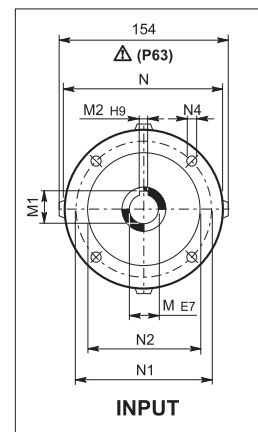
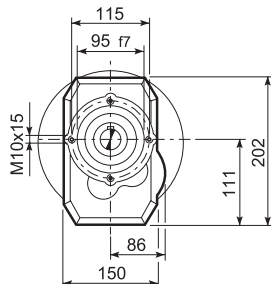
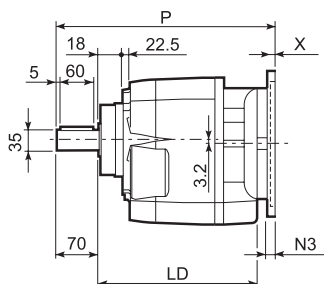

UF

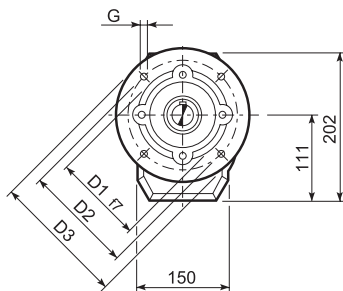
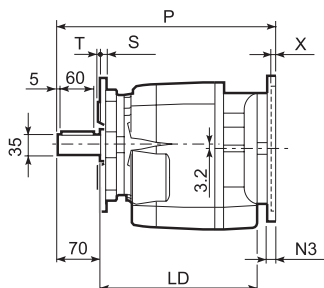

C 36 U

	D1	D2	D3	G	T	S
FA	130	165	200	11	3.5	11
FB	180	215	250	14	4	14

		LD	M	M1	M2	N	N1	N2	N3	N4	X	P	kg
C 36 2/3	P63	226	11	12.8	4	140	115	95	—	M8x19	4	326	17
C 36 2/3	P71	226	14	16.3	5	160	130	110	—	M8x16	4.5	326	17
C 36 2/3	P80	236	19	21.8	6	200	165	130	—	M10x12	4	345.5	18
C 36 2/3	P90	236	24	27.3	8	200	165	130	—	M10x12	4	345.5	18
C 36 2/3	P100	236	28	31.3	8	250	215	180	—	M12x16	4.5	355.5	22
C 36 2/3	P112	236	28	31.3	8	250	215	180	—	M12x16	4.5	355.5	22
C 36 2/3	P132	—	38	41.3	10	300	265	230	16	14	5	392.5	25
C 36 4	P63	—	11	12.8	4	140	115	95	—	M8x19	4	383.5	20
C 36 4	P71	—	14	16.3	5	160	130	110	—	M8x16	4.5	383.5	20
C 36 4	P80	—	19	21.8	6	200	165	130	—	M10x12	4	403	21
C 36 4	P90	—	24	27.3	8	200	165	130	—	M10x12	4	403	21
C 36 4	P100	—	28	31.3	8	250	215	180	—	M12x16	4.5	413	25
C 36 4	P112	—	28	31.3	8	250	215	180	—	M12x16	4.5	413	25

C 36...HS

P

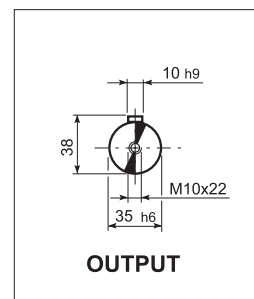
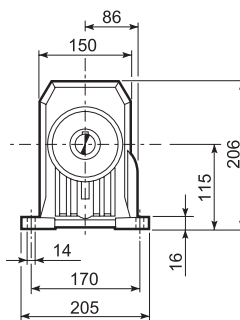
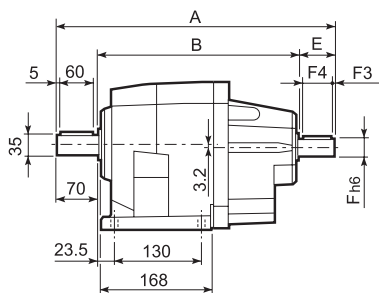

U

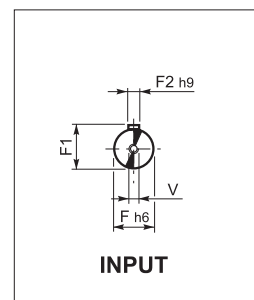
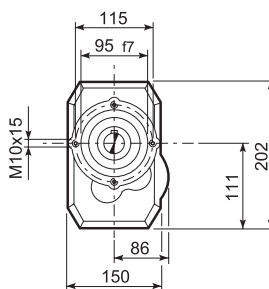
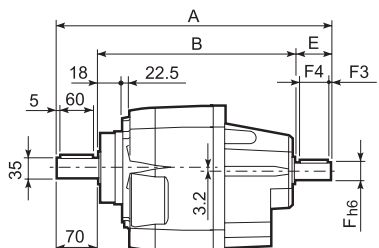

UF

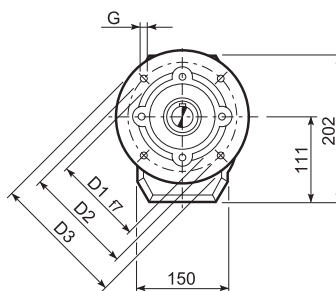
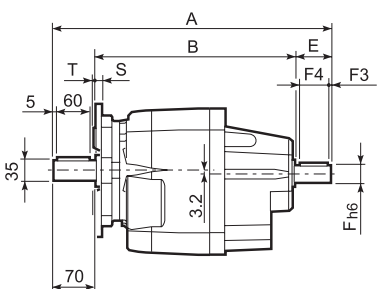

C 36 U						
	D1	D2	D3	G	T	S
FA	130	165	200	11	3.5	11
FB	180	215	250	14	4	14

		A	B	E	F	F1	F2	F3	F4	V	Kg
C 36 2	HS	415.5	295.5	50	24	27	8	2.5	45	M8x19	25.5
C 36 3		415.5	295.5	50	24	27	8	2.5	45	M8x19	25.5

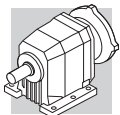

C 41...P(IEC)

P

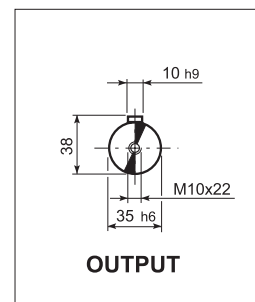
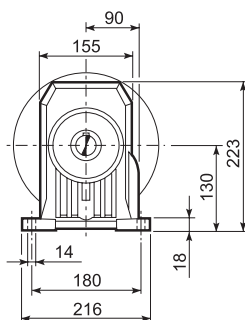
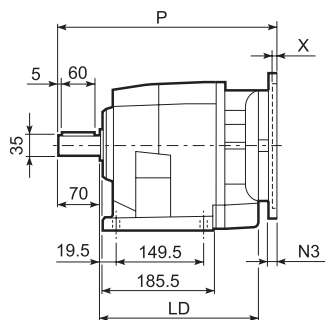

U

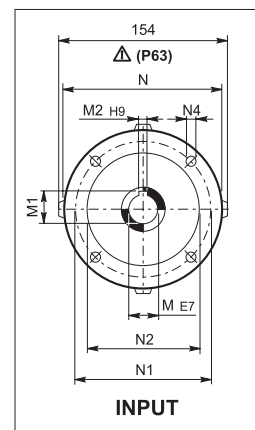
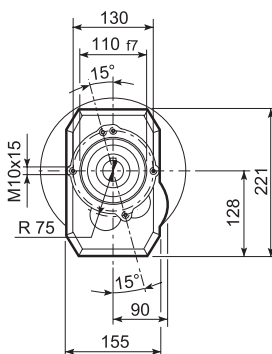
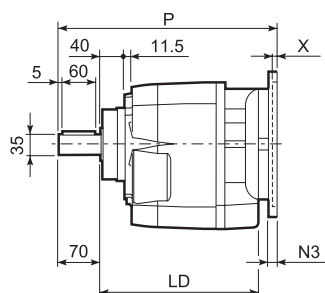

UF

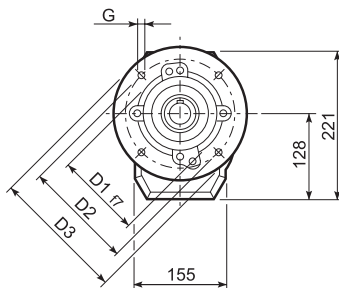
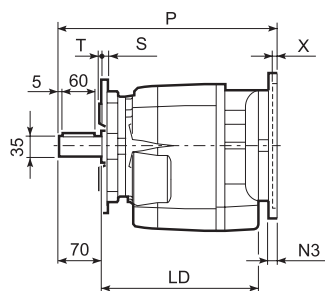

C 41_U

	D1	D2	D3	G	T	S
FA	130	165	200	11	3.5	11
FB	180	215	250	14	4	13

		LD	M	M1	M2	N	N1	N2	N3	N4	X	P	Kg
C 41 2/3	P63	235.5	11	12.8	4	140	115	95	—	M8x19	4	336.5	27
C 41 2/3	P71	235.5	14	16.3	5	160	130	110	—	M8x16	4.5	336.5	28
C 41 2/3	P80	251.5	19	21.8	6	200	165	130	—	M10x12	4	356	29
C 41 2/3	P90	251.5	24	27.3	8	200	165	130	—	M10x12	4	356	29
C 41 2/3	P100	—	28	31.3	8	250	215	180	—	M12x16	4.5	366	33
C 41 2/3	P112	—	28	31.3	8	250	215	180	—	M12x16	4.5	366	33
C 41 2/3	P132	—	38	41.3	10	300	265	230	16	14	5	402.5	35
C 41 4	P63	—	11	12.8	4	140	115	95	—	M8x19	4	395	30
C 41 4	P71	—	14	16.3	5	160	130	110	—	M8x16	4.5	395	31
C 41 4	P80	—	19	21.8	6	200	165	130	—	M10x12	4	414.5	32
C 41 4	P90	—	24	27.3	8	200	165	130	—	M10x12	4	414.5	32
C 41 4	P100	—	28	31.3	8	250	215	180	—	M12x16	4.5	424.5	36
C 41 4	P112	—	28	31.3	8	250	215	180	—	M12x16	4.5	424.5	36

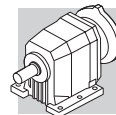

C 41...HS

P

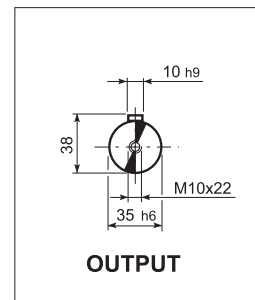
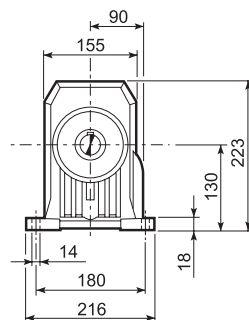
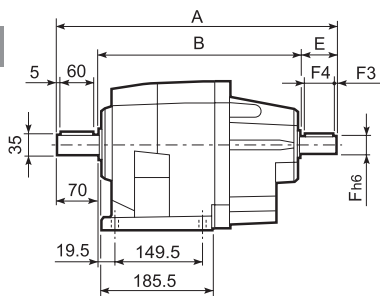

U

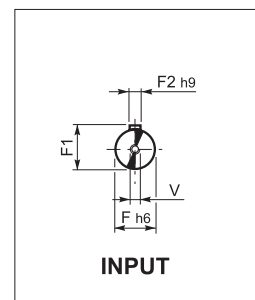
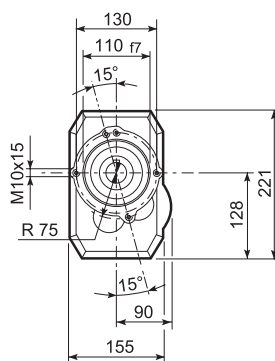
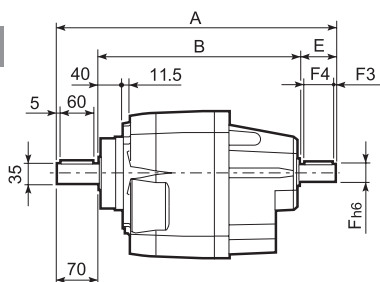

UF

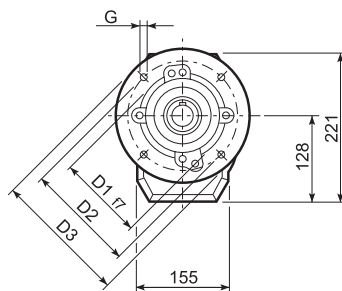
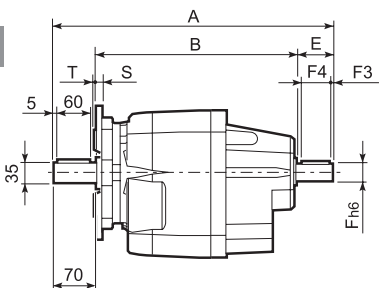

C 41 U						
	D1	D2	D3	G	T	S
FA	130	165	200	11	3.5	11
FB	180	215	250	14	4	13

		A	B	E	F	F1	F2	F3	F4	V	Kg
C 41 2	HS	425.5	305.5	50	24	27	8	2.5	45	M8x19	30
C 41 3		425.5	305.5	50	24	27	8	2.5	45	M8x19	30
C 41 4		448	338	40	19	21.5	6	2.5	35	M6x16	33

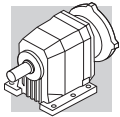

C 51...P(IEC)

P

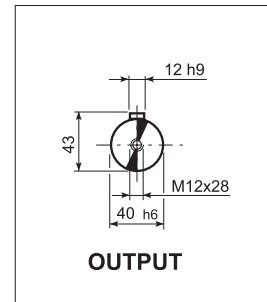
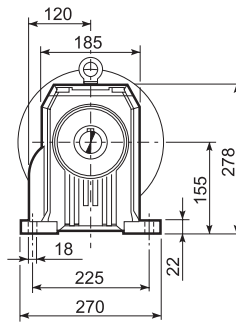
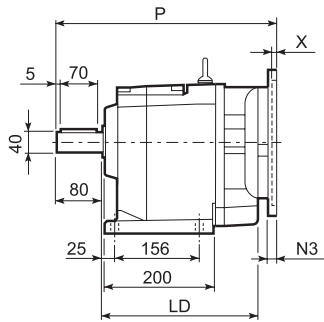

U

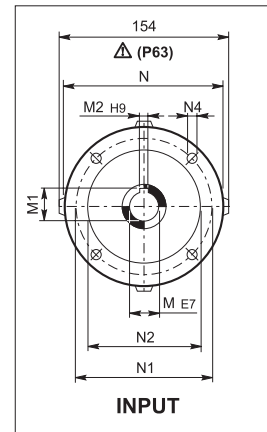
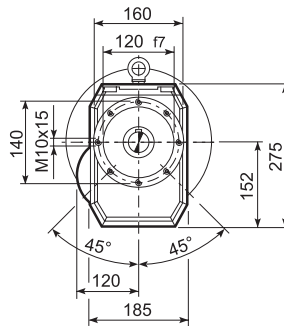
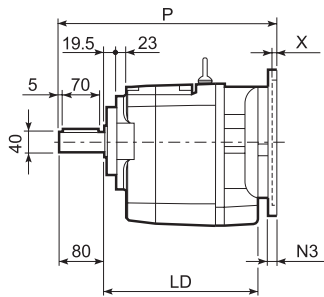

UF

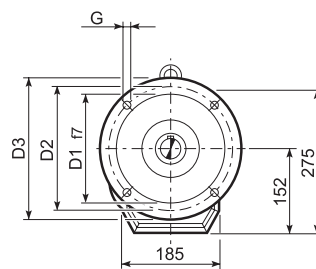
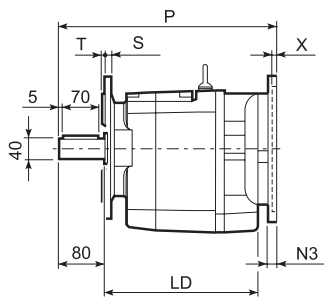

C 51_U

	D1	D2	D3	G	T	S
FA	180	215	250	14	4	13
FB	230	265	300	14	4	16

		LD	M	M1	M2	N	N1	N2	N3	N4	X	P	Kg
C 51 2/3	P63	252.5	11	12.8	4	140	115	95	—	M8x19	4	362.5	45
C 51 2/3	P71	252.5	14	16.3	5	160	130	110	—	M8x16	4.5	362.5	45
C 51 2/3	P80	267.5	19	21.8	6	200	165	130	—	M10x12	4	382	47
C 51 2/3	P90	267.5	24	27.3	8	200	165	130	—	M10x12	4	382	47
C 51 2/3	P100	252.5	28	31.3	8	250	215	180	—	M12x16	4.5	392	51
C 51 2/3	P112	252.5	28	31.3	8	250	215	180	—	M12x16	4.5	392	51
C 51 2/3	P132	252.5	38	41.3	10	300	265	230	16	14	5	428.5	54
C 51 2/3	P160	—	42	45.3	12	350	300	250	23	18	5.5	479	58
C 51 2/3	P180	—	48	51.8	14	350	300	250	23	18	5.5	479	58
C 51 4	P63	—	11	12.8	4	140	115	95	—	M8x19	4	434	47
C 51 4	P71	—	14	16.3	5	160	130	110	—	M8x16	4.5	434	47
C 51 4	P80	—	19	21.8	6	200	165	130	—	M10x12	4	453.5	49
C 51 4	P90	—	24	27.3	8	200	165	130	—	M10x12	4	463.5	49
C 51 4	P100	—	28	31.3	8	250	215	180	—	M12x16	4.5	463.5	53
C 51 4	P112	—	28	31.3	8	250	215	180	—	M12x16	4.5	463.5	53
C 51 4	P132	—	38	41.3	10	300	265	230	16	14	5	500	62

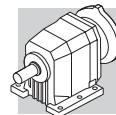

C 51...HS

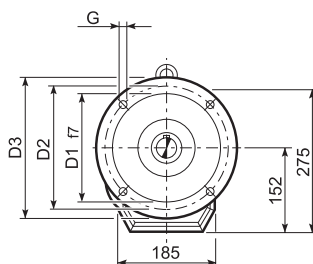
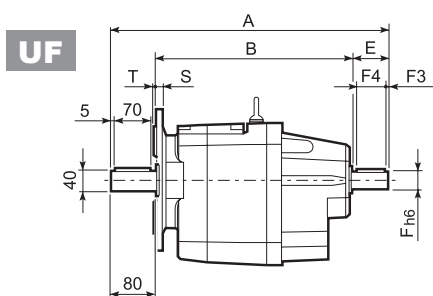
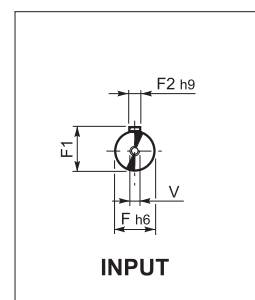
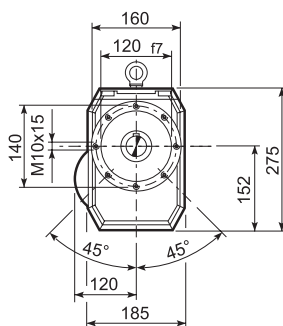
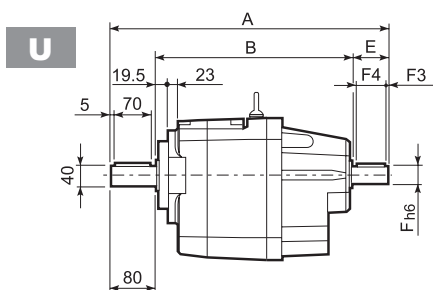
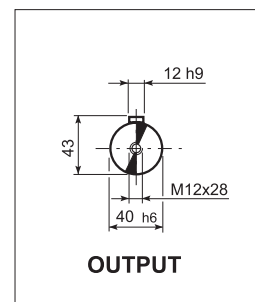
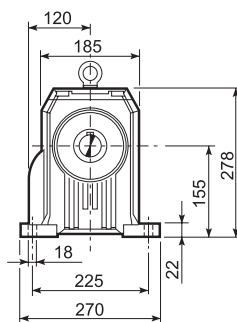
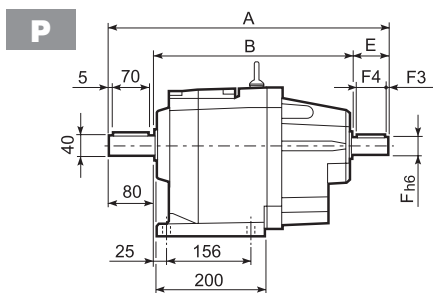

C 51 U						
	D1	D2	D3	G	T	S
FA	180	215	250	14	4	13
FB	230	265	300	14	4	16

		A	B	E	F	F1	F2	F3	F4	V	kg
C 51 2	HS	451.5	322	50	24	24	8	2.5	45	M8x19	45
C 51 3		451.5	322	50	24	24	8	2.5	45	M8x19	45
C 51 4		484	364	40	19	21.5	6	2.5	35	M6x16	48

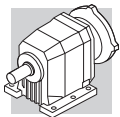

C 61...P(IEC)

P

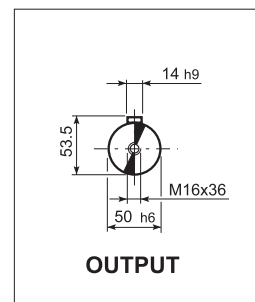
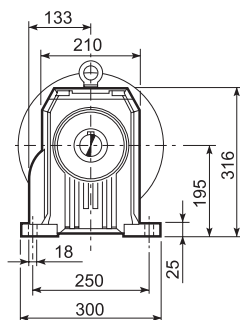
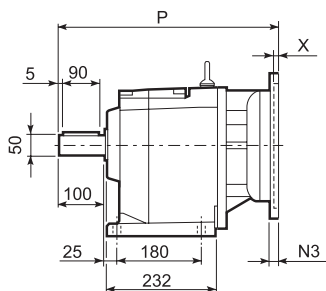

U

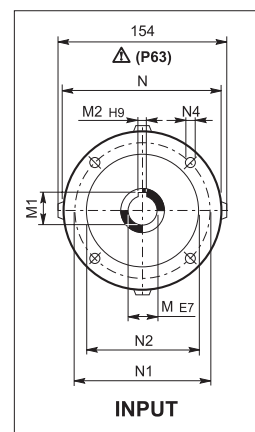
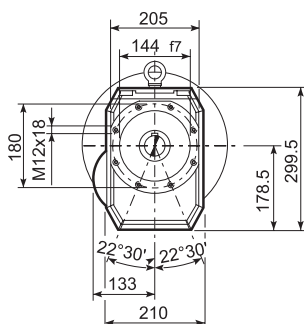
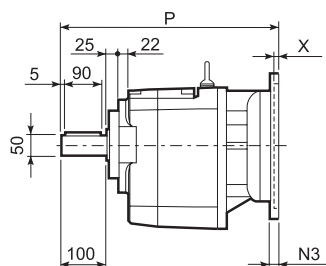

UF

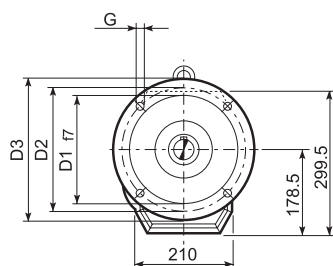
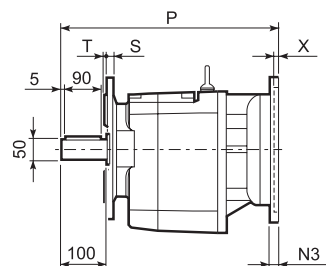

C 61_U

	D1	D2	D3	G	T	S
FA	230	265	300	14	4	16
FB	250	300	350	18	5	18

		M	M1	M2	N	N1	N2	N3	N4	X	P	Kg
C 61 2/3	P63	11	12.8	4	140	115	95	—	M8x19	4	415.5	55
C 61 2/3	P71	14	16.3	5	160	130	110	—	M8x16	4.5	415.5	57
C 61 2/3	P80	19	21.8	6	200	165	130	—	M10x12	4	435	61
C 61 2/3	P90	24	27.3	8	200	165	130	—	M10x12	4	435	61
C 61 2/3	P100	28	31.3	8	250	215	180	—	M12x16	4.5	444	65
C 61 2/3	P112	28	31.3	8	250	215	180	—	M12x16	4.5	444	65
C 61 2/3	P132	38	41.3	10	300	265	230	16	14	5	481.5	68
C 61 2/3	P160	42	45.3	12	350	300	250	23	18	5.5	532	73
C 61 2/3	P180	48	51.8	14	350	300	250	23	18	5.5	532	73
C 61 4	P63	11	12.8	4	140	115	95	—	M8x19	4	486	61
C 61 4	P71	14	16.3	5	160	130	110	—	M8x16	4.5	489	63
C 61 4	P80	19	21.8	6	200	165	130	—	M10x12	4	505.5	67
C 61 4	P90	24	27.3	8	200	165	130	—	M10x12	4	505.5	67
C 61 4	P100	28	31.3	8	250	215	180	—	M12x16	4.5	515.5	71
C 61 4	P112	28	31.3	8	250	215	180	—	M12x16	4.5	515.5	71

C 61...HS

P

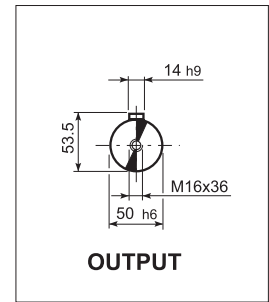
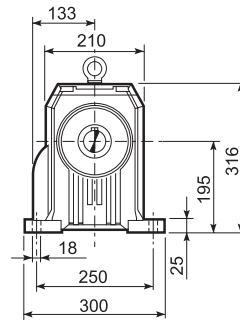
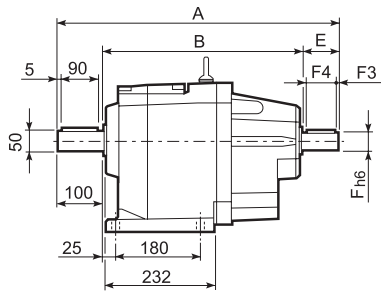

U

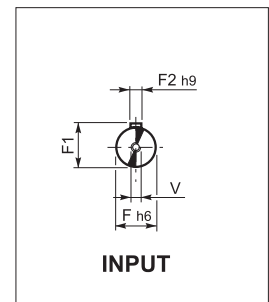
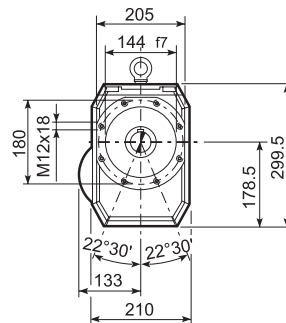
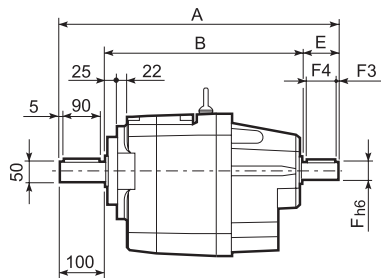

UF

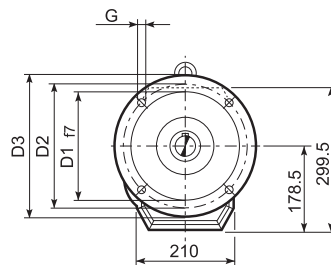
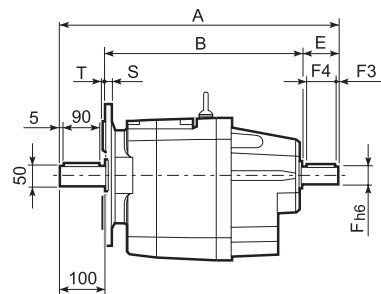

C 61_U						
	D1	D2	D3	G	T	S
FA	230	265	300	14	4	16
FB	250	300	350	18	5	18

		A	B	E	F	F1	F2	F3	F4	V	Kg
C 61 2	HS	532	372	60	28	31	8	5	50	M10x22	66
C 61 3		532	372	60	28	31	8	5	50	M10x22	66
C 61 4		575	425	50	24	27	8	2.5	45	M8x19	72

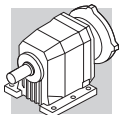

INDEX OF REVISIONS (R)

BR_CAT_C_ATX_ENG_R01_2	
	Description
17	“Gearbox rating charts” section updated
25	“Motor availability” section updated.
35 ... 47	“Dimensions” section updated.

2017 09 30

This publication supersedes and replaces any previous edition and revision. We reserve the right to implement modifications without notice. This catalogue cannot be reproduced, even partially, without prior consent.



We have a relentless commitment to excellence, innovation and sustainability. Our team creates, distributes and services world-class power transmission and drive solutions to keep the world in motion.



HEADQUARTERS

Bonfiglioli Riduttori S.p.A.
Via Giovanni XXIII, 7/A
40012 Lippo di Calderara di Reno
Bologna (Italy)
tel: +39 051 647 3111
fax: +39 051 647 3126
bonfiglioli@bonfiglioli.com
www.bonfiglioli.com