

siegling prolink modular belts

PRODUCT RANGE

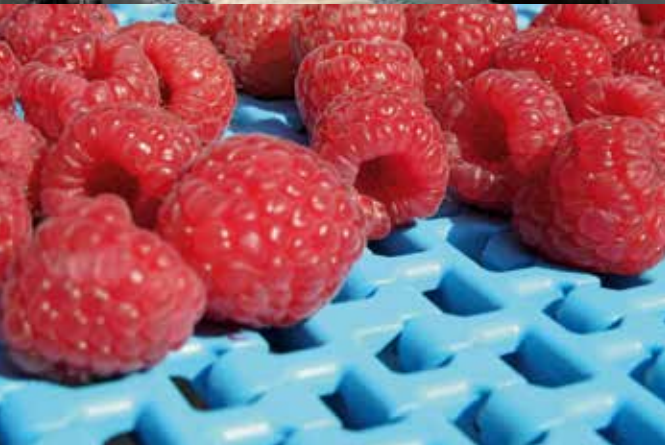
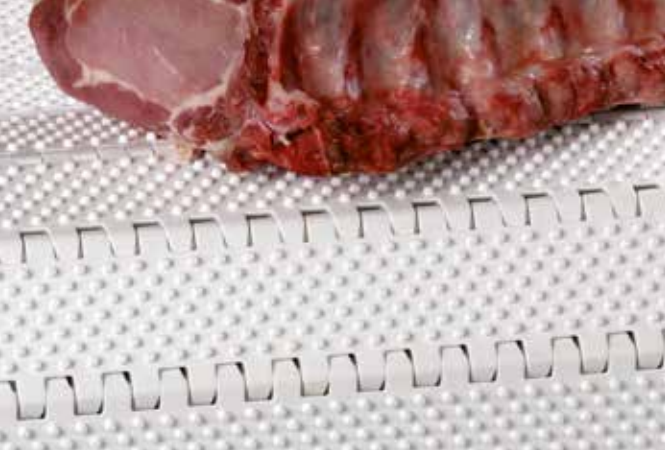

Traditional conveyor belts are often intended for generic use, but the design features of Siegling Prolink modular belts are aimed at providing specific processing and application benefits. This is why the Siegling Prolink modular belts are a perfect addition to Forbo Movement Systems existing wide range of belting products. Our vast experience in conveying and processing applications, combined with our line of highly specialized belts ensure that we can offer optimized conveying solutions regardless of the application. The Forbo Movement Systems name is synonymous with not only superior product quality, but also with professional technical support and quality service.

SIEGLING PROLINK PLASTIC MODULAR BELTING

Modular means adaptable

Siegling Prolink offer a wide product range with many different module designs. Modules within individual product series can easily be combined. As a result, Siegling Prolink modular belts can be customized to suit individual conveying and processing tasks. We will help you identify the optimal solution for your specific needs.

Siegling Prolink is used successfully in a broad range of applications in industries such as:

- **fruit and vegetable processing**
- **baked goods manufacturing**
- **meat, poultry and seafood processing**
- **automotive and tire manufacturing**
- **logistics**

In these areas, Siegling Prolink modular belts often play a significant role beyond conveying.

Benefits of modular belting

Modular belts are robust and durable and can handle conveying and processing tasks which may not be possible with conventional conveyor belting materials and types.

When assembled and installed, modular belts are endless, but if damage occurs, individual modules can quickly be replaced, thereby minimizing down time and maintenance costs. Modular belts can be supplied in any length and width and if needed, functional modules can be added at any time so belt properties can be changed if required.

The Siegling Prolink System – Every belt is a specialist!

Design and quality

Sophisticated module design, precise manufacturing and high-quality materials ensure optimal belt and application performance.

Page 5

Functions and types

The right belt for any application! The availability of a wide range of Siegling Prolink belts are shown by pitch, surface options and application (straight running and side-flexing)

Page 7

Materials and properties

In addition to standard materials, a lot of belt types are made of special materials. An overview.

Page 27



The high quality standards applied to the manufacturing and fabrication of Siegling Prolink modular belts ensure optimal application performance and the highest level of customer satisfaction. Our products are manufactured in accordance with the ISO 9001 QM-system which is audited and updated quarterly. Manufacturing tolerances, on-going testing and monitoring performed by our highly trained staff ensure a consistent and high level of product quality.

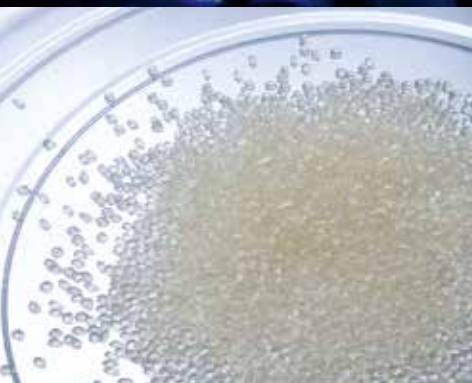

SIEGLING PROLINK DESIGN AND QUALITY

R & D Concepts

When developing Siegling Prolink modular belts and components, we collaborate closely with OEMs and end-users to ensure that customer expectations and application requirements are met. Many Prolink components are designed for particular conveying applications and processing requirements. This is your guarantee for optimal application performance when utilizing Siegling Prolink modular belts.

- **application-driven module designs for challenging requirements**
- **efficient and effective R&D processes**
- **exceptional value**

Manufacturing quality

Our state-of-the-art design, tooling and processing technology reflect the importance we place on the ability to manufacture flawless components and parts according to specifications. A smooth surface is one of the hallmarks of superior-quality injection molded parts. We place an emphasis on maximizing the quality and consistency of all molded parts.

- **less contamination risk**
- **easy to clean**
- **reliable conveying, even of sensitive products**

Tolerances

Siegling Prolink injection molded modules and components as well as assembled belts are manufactured to tight tolerances. This is an integral part of our overall product design and allows for easy and efficient fabrication, and belt repair if needed. Reliable, actual belt dimensions are easily obtainable and can help simplify conveyor designs.

- **actual belt dimensions easily obtainable**
- **simplified conveyor designs**

Materials

We apply the same stringent requirements and demands from our material suppliers as we do from ourselves. Close collaboration with suppliers and vendors not only guarantees consistently high-quality parts and components when using standard materials but also when special materials are needed from time to time to meet specific application requirements and conditions. This is especially important if application temperatures are excessive or if chemical degradation from sanitizers is likely.

- **superior functionality under all normal conditions**
- **long service life for belts and components**

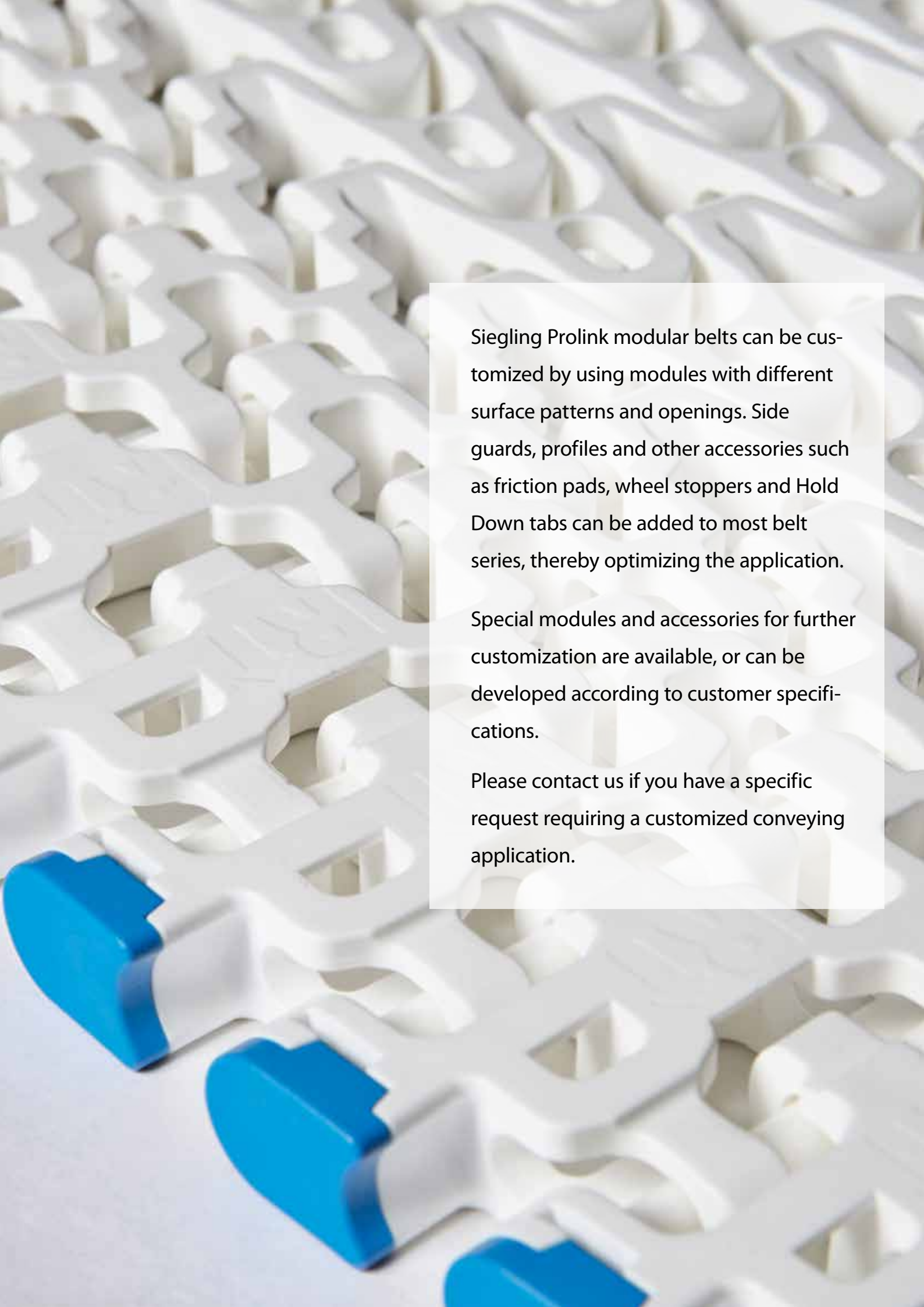
A close-up photograph of a white modular conveyor belt. The belt is composed of interlocking plastic links. In the foreground, several blue friction pads are attached to the bottom of the links. The background shows the repeating pattern of the white links, which have various shaped openings. The lighting is bright, highlighting the texture and three-dimensional nature of the components.

Siegling Prolink modular belts can be customized by using modules with different surface patterns and openings. Side guards, profiles and other accessories such as friction pads, wheel stoppers and Hold Down tabs can be added to most belt series, thereby optimizing the application.

Special modules and accessories for further customization are available, or can be developed according to customer specifications.

Please contact us if you have a specific request requiring a customized conveying application.

SIEGLING PROLINK FUNCTIONS AND TYPES

Straight running belts

Pitch 8 mm (0.31 in)



S13 | 0% open | Flat Top

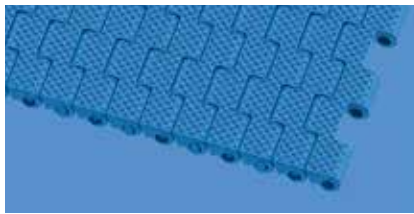

S13 | 0% open | Negative Pyramid

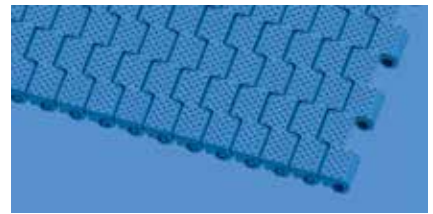

S13 | 0% open | Cone Top



S13 | 34% open | Flat Top

Pitch 12.7 mm (0.5 in)

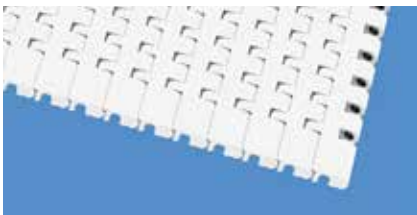

S14 | 0% open | Flat Top



S14 | 25% open | Flat Top

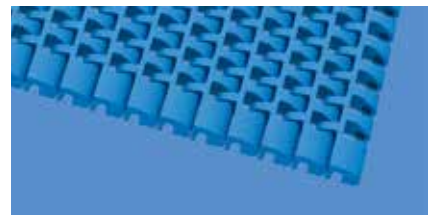

S14 | 25% open | Curved Top

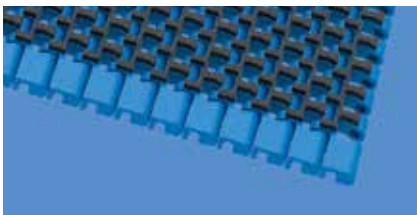

S14 | 25% open | Friction Top 1

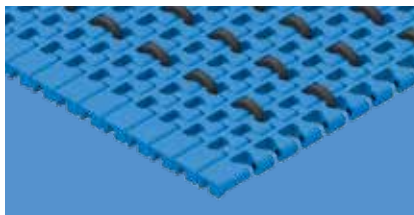

S14 | 25% open | FLT with PRR



S15 | 47% open | Grid Top

Continued on next page

Straight running belts

Pitch 12.7 mm (0.5 in)



S15 | 47% open | Reduced surface area

Pitch 14 mm (0.55 in)

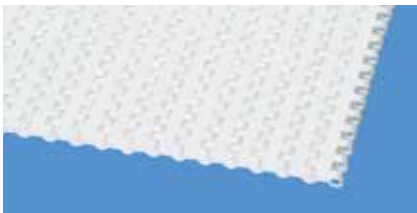

S4.1 | 0% open | Flat Top



S4.1 | 0% open | Negative Pyramid

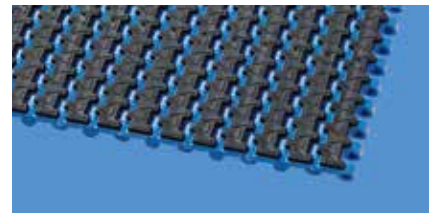

S4.1 | 0% open | Friction Top 1

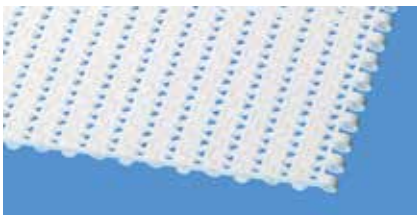

S4.1 | 21% open | Flat Top

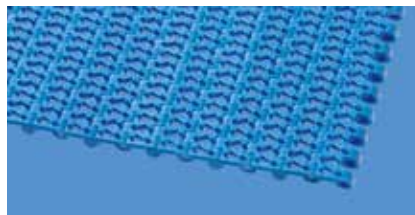

S4.1 | 21% open | Nub Top

Pitch 25 mm (1 in)



S2 | 0% open | Flat Top



S2 | 12% open | Flat Top



S2 | 57% open | Grid Top



S2 | 57% open | Raised Rib



S2 | 0% open | Friction Top 1

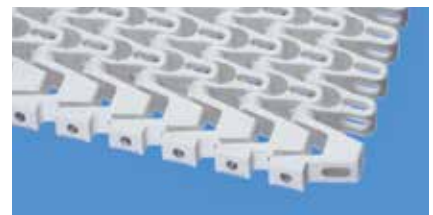

S5 | 45% open | Grid Top

Pitch 25 mm (1 in)

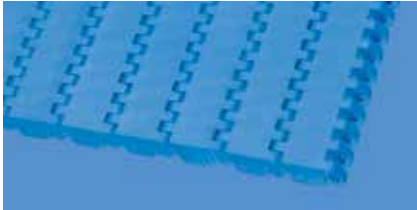

S8.1 | 0% open | Flat Top

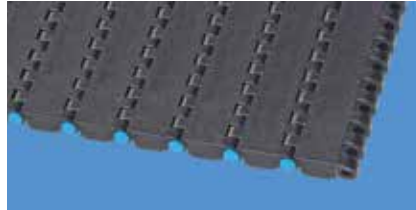

S8.1 | 0% open | Slip-resistant



S8.1 | 0% open | Non Skid

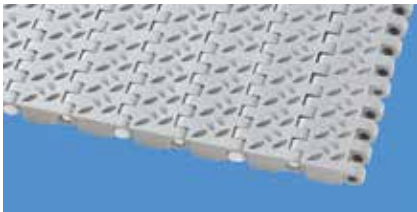

S8.1 | 0% open | Non Skid 2

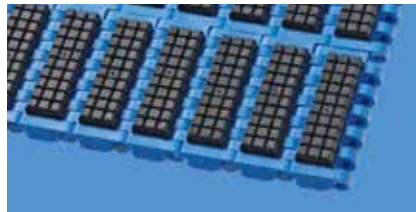

S8 | 0% open | Friction Top 1

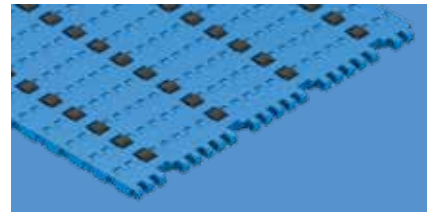

S8.1 | 0% open | FLT with PRR

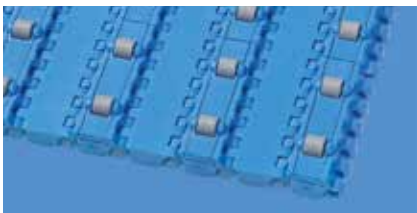

S8 | 0% open | Roller Top A90



S8 | 25% open | Radius Top

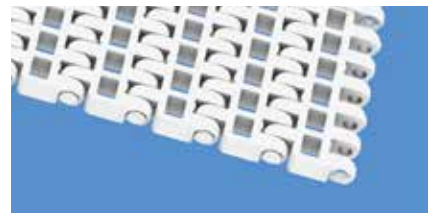

S8.1 | 30% open | Flat Top

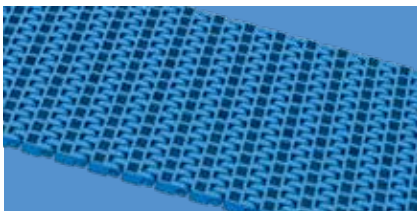

S8.1 | 30% open | Flat Top - guided



S10 | 0% open | Flat Top

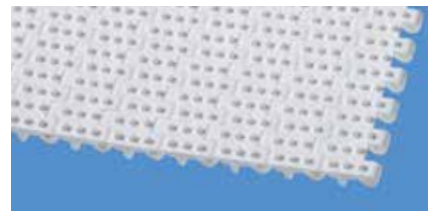

S10 | 0% open | Nub Top

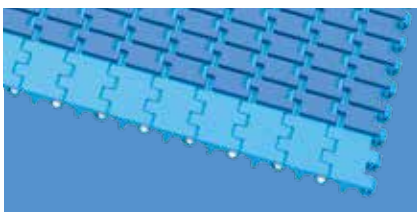

S10 | 0% open | Friction Top 1

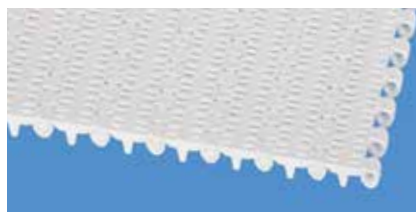

S10 | 22% open | Flat Top

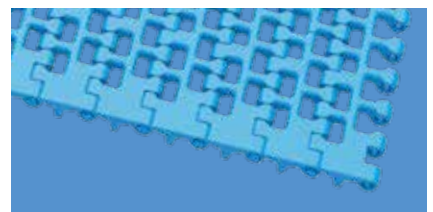

S10 | 36% open | Flat Top

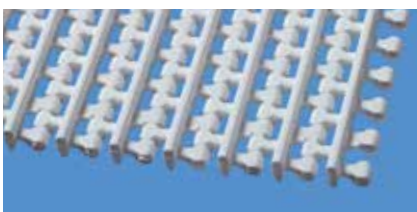

S10 | 36% open | Lateral Rib

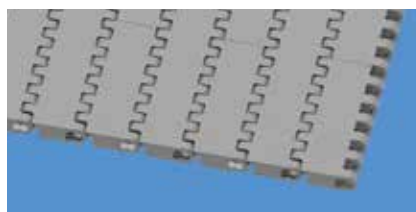

S17 | 0% open | Flat Top



S17 | 0% open | Slip-resistant

Continued on next page

Straight running belts

Pitch 25 mm (1 in)



S18 | 44% open | Grid Top 2.2

Pitch 40 mm (1.6 in)



S7 | 0% open | Flat Top



S7 | 0% open | Slip-resistant



S7 | 0% open | Non Skid

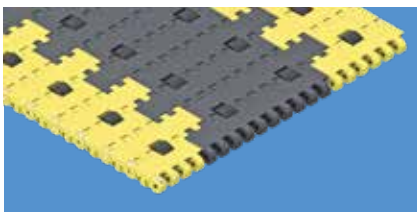

S7 | 0% open | FLT with PRR



S7 | 0% open | Friction Top 1

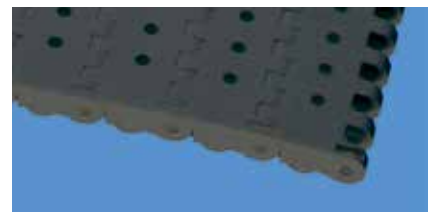

S7 | 6% open | Flat Top



S7 | 6% open | Non Skid

Pitch 50 mm (2 in)



S1 | 0% open | Flat Top

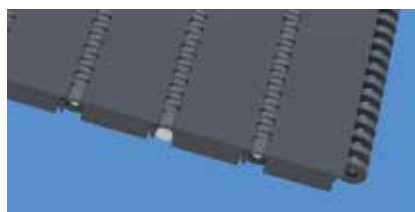

S1 | 0% open | Slip-resistant



S1 | 0% open | Non Skid

Pitch 50 mm (2 in)



S1 | 0% open | Friction Top 1



S1 | 18% open | Flat Top



S6.1 | 0% open | Flat Top



S6.1 | 0% open | Nub Top



S6.1 | 0% open | Cone Top

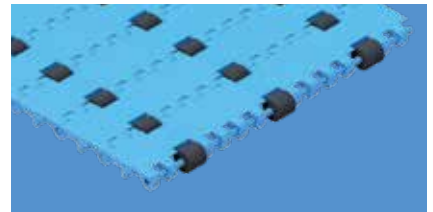

S6.1 | 0% open | FLT with PRR

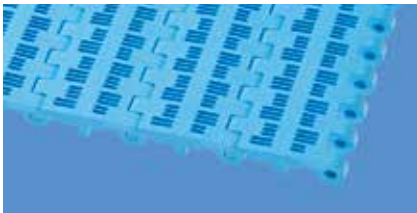

S6.1 | 21% open | Flat Top

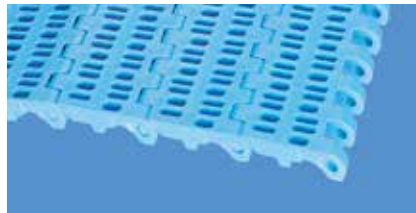

S6.1 | 23% open | Flat Top

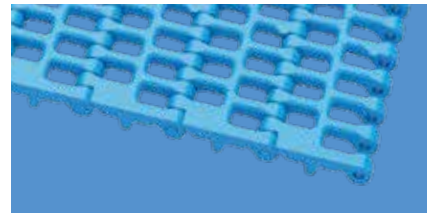

S6.1 | 36% open | Flat Top

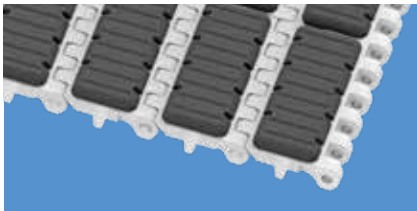

S6.1 | 0% open | Friction Top 1



S9 | 57% open | Grid Top



S9.1 | 57% open | Grid Top

Pitch 63.5 mm (2.5 in)

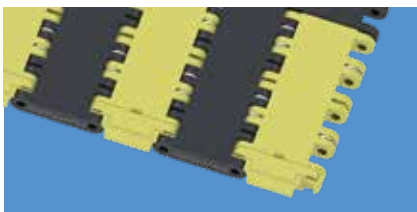

S19 | 0% open | Slip-resistant

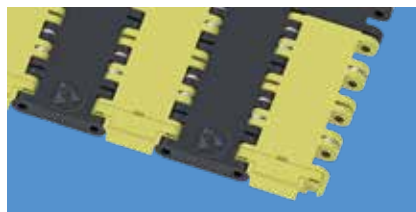

S19 | 0% open | Slip-resistant, highly conductive

Continued on next page

Side flexing and spiral belts

Pitch 25 mm (1 in)



S5 | 33% open | Friction Top 2



S5 | 39% open | Friction Top 1



S5 | 45% open | Grid Top



S5 | 45% open | Grid Top Guided



S5 | 45% open | Grid Top Reverse Guided



S5 | 45% open | Grid Top Strong



S5 | 45% open | Nub Top



S5 | 45% open | Bearing Tab Module

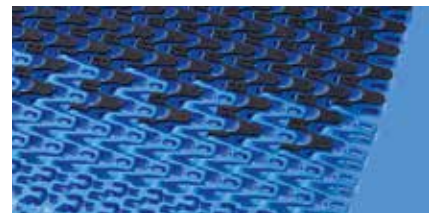

S11 | 33% open | Friction Top 2

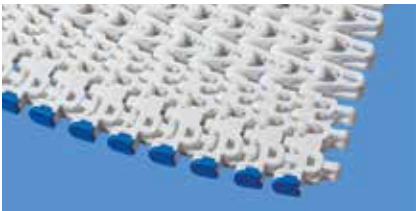

S11 | 45% open | Grid Top

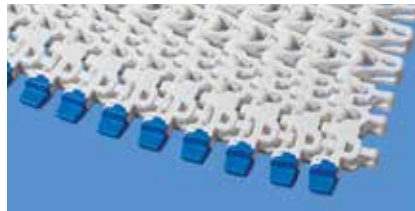

S11 | 45% open | Hold Down Caps

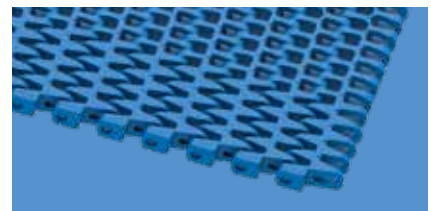

S18 | 44% open | Grid Top 1.7

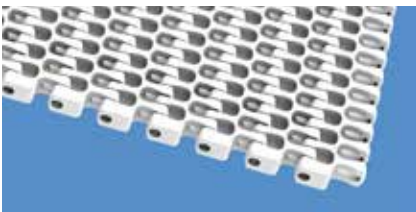

S18 | 44% open | Grid Top 2.2

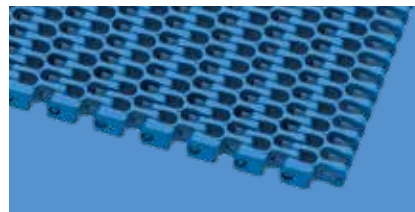

S18 | 44% open | Grid Top 2.2 Guided

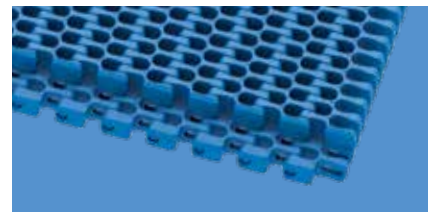

S18 | 44% open | High Deck 2.2

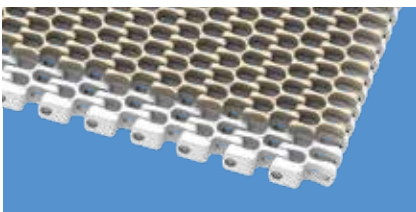

S18 | 44% open | Friction Top 1

Pitch 50 mm (2 in)



S9 | 57% open | Grid Top



S9 | 57% open | Grid Top Guided



S9 | 57% open | Nub Top



S9.1 | 57% open | Grid Top

Modular belt series – Overview

Series	Pitch	Description
1	50 mm (2 in)	Medium to heavy-duty belt for industrial conveying tasks. Closed hinge design.
2	25 mm (1 in)	Light-duty belt for food, container handling and industrial use. Open hinge design.
4.1	14 mm (0.55 in)	Light to medium-duty belt for food and non-food use. Small pitch allows tight product transfers using nose bars or sprockets. Open hinge design.
5	25 mm (1 in)	Light to medium-duty radius and spiral belt with stainless steel hinge pins. Exceptionally strong and versatile side flexing belt with large open area.
6.1	50 mm (2 in)	Medium to heavy-duty belt designed specifically for tasks requiring the highest hygiene standards in meat, poultry and seafood processing, including cutting, deboning and skinning lines. Easy to clean. Open hinge design.
7	40 mm (1.6 in)	Heavy-duty belt with superior pull strength and excellent durability for industrial applications. Designed for heavy loads, such as worker belts for the automotive industry, vehicle conveying, etc. Closed hinge design.
8.1	25.4 mm (1 in)	Medium to heavy-duty belt for industrial applications. Closed hinge design.
9	50 mm (2 in)	Medium to heavy-duty radius and spiral belt with stainless steel hinge pins. Exceptionally strong and versatile side flexing belt with large open area.
9.1	50 mm (2 in)	Medium to heavy-duty spiral belt with stainless steel hinge pins. Exceptionally strong side flexing belt with large open area, clip-free design and adjustable belt radius of 1.3 to 2.9 x belt width.
10	25.4 mm (1 in)	Light to medium-duty belt for hygiene-sensitive products. Easy to clean. Open hinge design.
11	25 mm (1 in)	Side flexing belt for conveying lightweight products. This lightweight belt has an exceptionally low turn radius of 1.4 x belt width.
13	8 mm (0.31 in)	Light-duty micro pitch belt for food and non-food tight-transfer nose bar use. Open hinge design.
14	12.7 mm (0.5 in)	Medium-duty belt for food and non-food use. Small pitch allows tight product transfers. Bottom design optimized for nose bars. Strong closed hinge design.
15	12.7 mm (0.5 in)	Light-duty belt for food applications utilizing 12.7 mm (0.5 in) nose bars
17	25.4 mm (1 in)	Medium to heavy-duty belt for industrial applications. Closed hinge design.
18	25.4 mm (1 in)	Light to medium-duty belt for food and non-food applications
19	63.5 mm (2.5 in)	Exceptionally strong, flexible-to-configure solution for heavy-load assembly lines (HEAL). This steel-reinforced plastic modular belt delivers superior strength, reliable performance and consistently low running costs.

Please note: Series 3 is replaced by Series 6.1 offering same options in higher quality and improved cleanability.

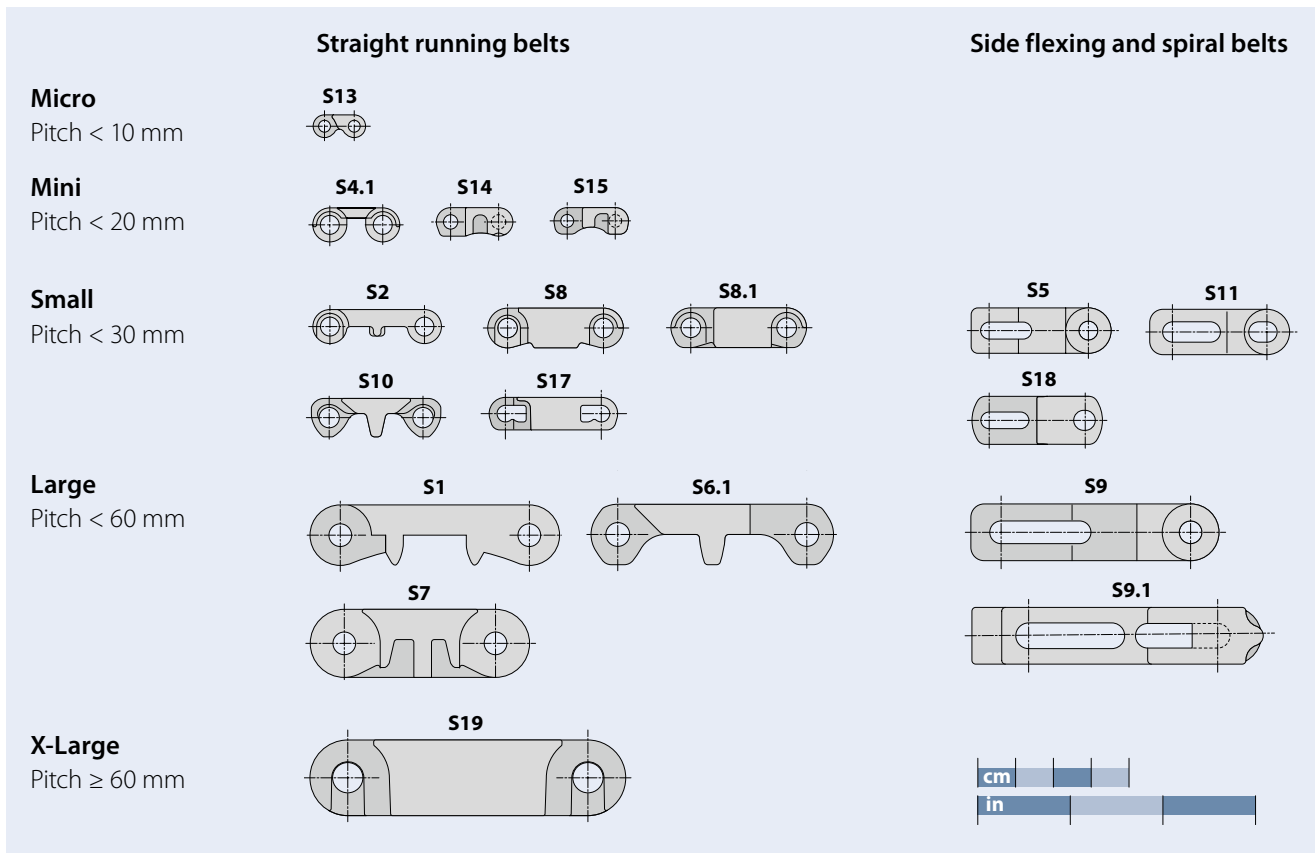

Load index

The following table shows the changes in load capacity between different materials and over all available series.

Straight running belts

Series	PA	PE	POM	PP
S1	–	60%	133%	100%
S2	17%	10%	23%	17%
S4.1	33%	10%	33%	17%
S5	–	33%	83%	60%
S6.1	100%	43%	100%	60%
S7	–	60%	200%	100%
S8, S8.1	100%	–	133%	67%
S8-0 RTP	–	–	67%	–
S9, S9.1	80%	40%	100%	73%
S10-0 FLT, S10-0 NTP, S10-0 FRT1	–	20%	67%	27%
S10-22 FLT	–	10%	37%	17%
S10-36 FLT, S10-36 LRB	43%	13%	43%	20%
S11	50%	–	50%	30%
S13	–	–	13%	–
S14	–	22%	80%	30%
S15	15%	–	17%	8%
S17	–	–	107%	60%
S19	266%	–	300%	–
S19 (100)	566%	–	600%	–

Side flexing and spiral belts

Series	PA	PE	POM	PP
S5	–	–	100%	56%
S5 RG, S5 ST	–	–	117%	67%
S9, S9.1	124%	–	156%	89%
S11	56%	–	56%	33%
S18	–	–	89%	56%

Straight running belts

Series 1 | Pitch 50 mm (1.97 in)

Belts for medium to heavy-duty industrial conveying applications

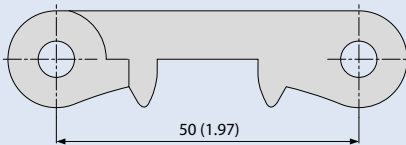

Design characteristics

- Narrow, closed hinge design provides high belt pull capacity
- Rigid module design makes belt suitable for long conveyors
- Closed solid edge design

Available surface pattern and opening area

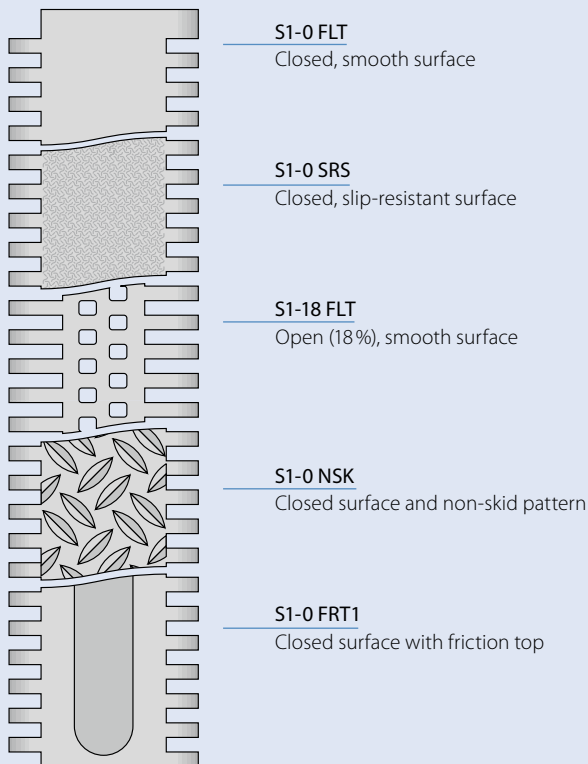

Sprockets, profiles and side guards available in different sizes and designs

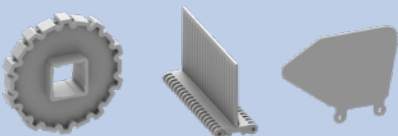

Series 2 | Pitch 25 mm (0.98 in)

Belts for light-duty food and container handling applications

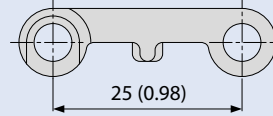

Design characteristics

- Hinges that open wide provides an easy-to-clean belt design
- Low belt weight reduces energy consumption
- Open edge design on flat top versions for unhindered drainage and closed edge design on grid top and raised rib versions

Available surface pattern and opening area

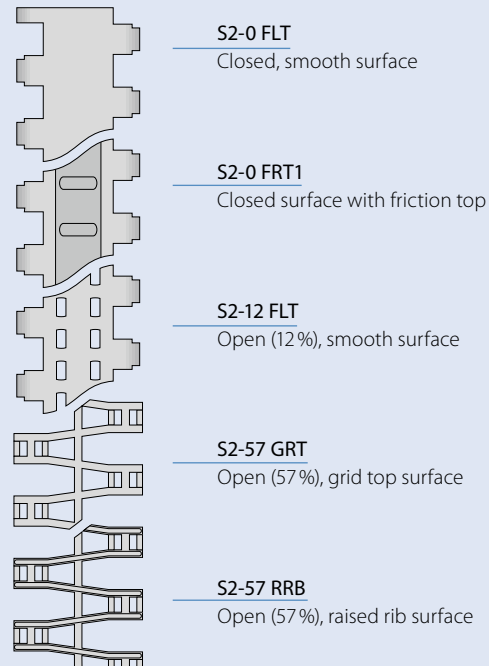

Sprockets, profiles, side guards and finger plates available in different sizes and designs

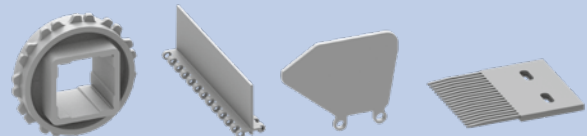

Series 4.1 | Pitch 14 mm (0.55 in)

Belts for light to medium-duty food and non-food applications

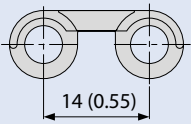

Design characteristics

- Small pitch belt for applications requiring small transfer gaps
- Hinges that open wide and flat channels on the underside ensure the belt is easy to clean
- Unique sprocket design with rounded tooth edges provides ideal load distribution
- Wide sprocket teeth ensure superior sprocket engagement and strength

Available surface pattern and opening area

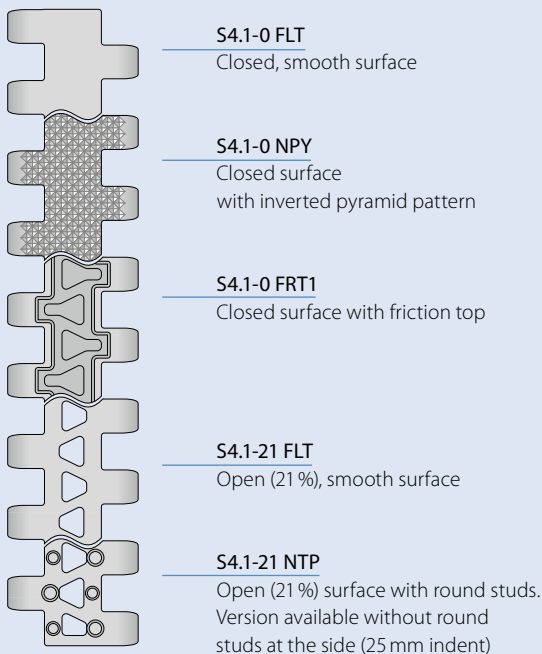

Sprockets, profiles and ProSnap Quick-Release available in different sizes and designs

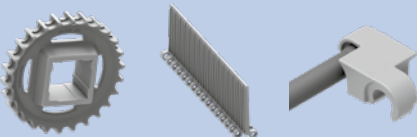

Series 6.1 | Pitch 50 mm (1.97 in)

Belts for medium to heavy-duty, hygiene-critical applications

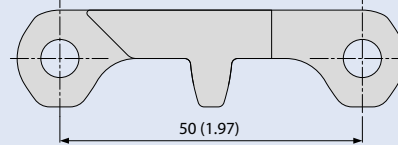

Design characteristics

- Wide modules and eyelets for less soiling
- Hinges that open wide, wide channels on the underside and a continuous drive bar for an easy-to-clean design
- Robust design and smooth, cut-resistant surface (depending on material)
- Special sprocket design with enhanced tooth engagement for excellent force transmission

Available surface pattern and opening area

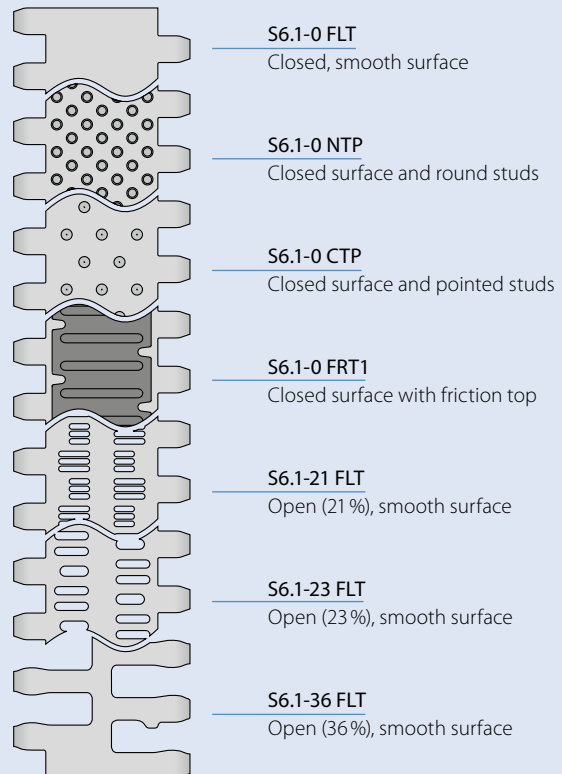

Sprockets, profiles, side guards, Hold Down tabs and ProSnap Quick-Release available in different sizes and designs



¹⁾ NSF-compliant from these certified Forbo plants: Huntersville (USA), Malacky (Slovakia), Tlalnepantla (Mexico)

Straight running belts

Series 7 | Pitch 40 mm (1.57 in)

Belts for heavy-duty non-food applications

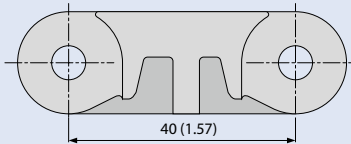

Design characteristics

- Closed-hinge design provides high belt pull capacity
- Small-pitch relative to belt thickness makes belt suitable for compact, heavily loaded conveyors
- Robust design with large surface contact area ensures superior wear life
- Closed solid edge
- Flame retardant version available (PXX-HC – in line with DIN EN 13501-1)

Available surface pattern and opening area

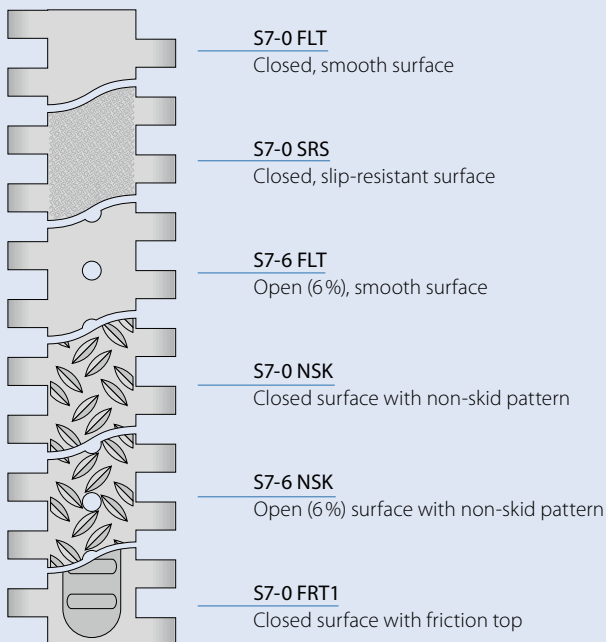

Sprockets and wheelstoppers available in different sizes and designs

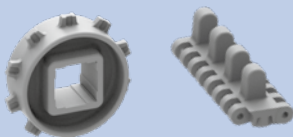

Series 8 | Pitch 25.4 mm (1 in)

Belts for medium to heavy-duty applications

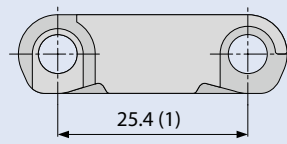

Design characteristics

- Closed hinge design provides high belt pull capacity
- Rigid module design makes belt suitable for long conveyors
- Exceptionally robust and durable module and sprocket design
- Closed solid edge design
- Flame retardant version available (PXX-HC – in line with DIN EN 13501-1)

Available surface pattern and opening area

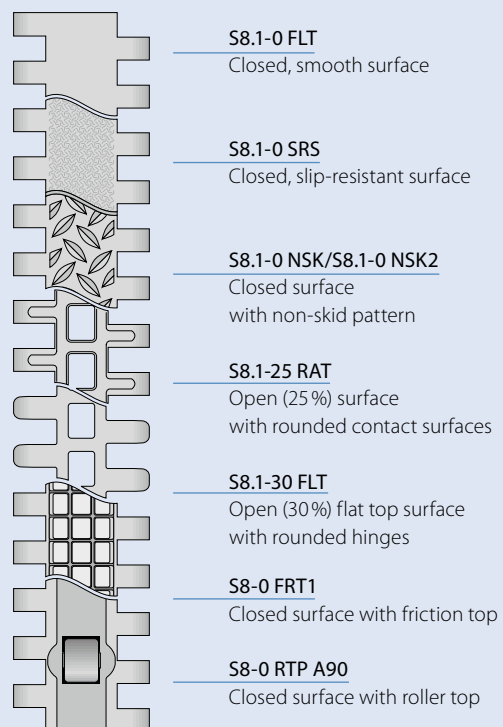

Sprockets, profiles, side guards and Hold Down tabs available in different sizes and designs

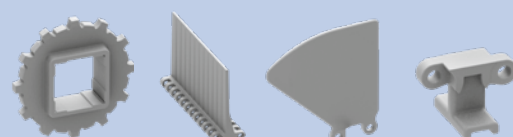

Series 10 | Pitch 25.4 mm (1 in)

Belts for light to medium-duty hygiene-critical applications

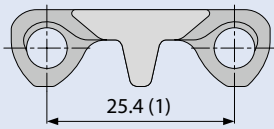

Design characteristics

- Small number of eyelets ensures easy cleaning
- Hinges that open wide, combined with smooth, flat channels on the underside and a continuous drive bar produce an easy-to-clean design
- Robust design guarantees superior durability
- Optimal design of sprocket teeth and tracking fins provides superior sprocket engagement, safe belt tracking and an easy-to-clean sprocket

Available surface pattern and opening area

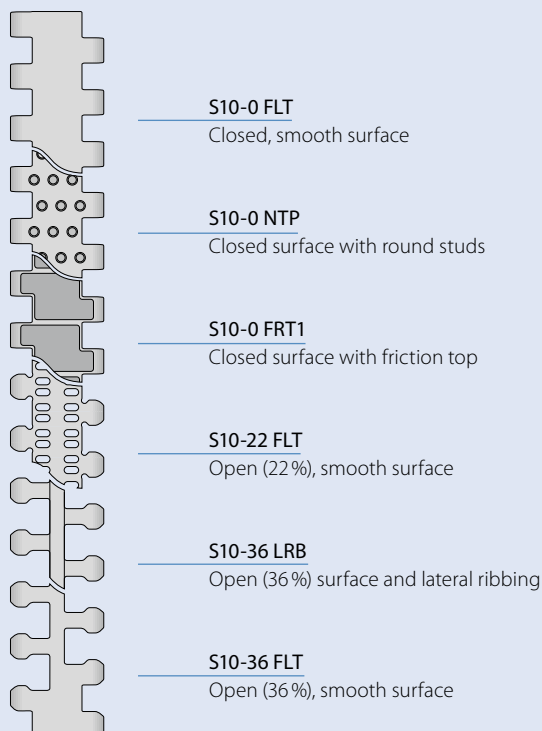

Sprockets, profiles, side guards and Hold Down tabs and ProSnap Quick-Release available in different sizes and designs

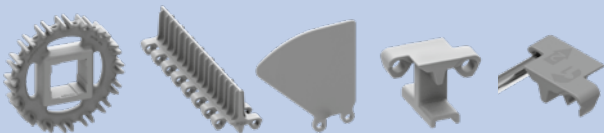

Series 13 | Pitch 8 mm (0.31 in)

Belts for light-duty food and non-food nose bar applications

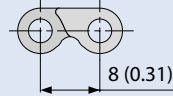

Design characteristics

- Micro pitch belt with small transfer gaps
- Designed to run over nose bars/knife edges or rollers with a radius down to 3 mm (0.12 in) allowing, precise transfer of even the smallest products
- Versatile for conveying, drying and cooling applications
- Optimal design of sprocket teeth, and belt underside provides superior sprocket engagement, safe belt tracking and good cleaning capabilities
- Belt and sprocket design ensures superior load transmission and belt pull capacity
- Headless pin making it very easy to install and remove the belt for maintenance

Available surface pattern and opening area

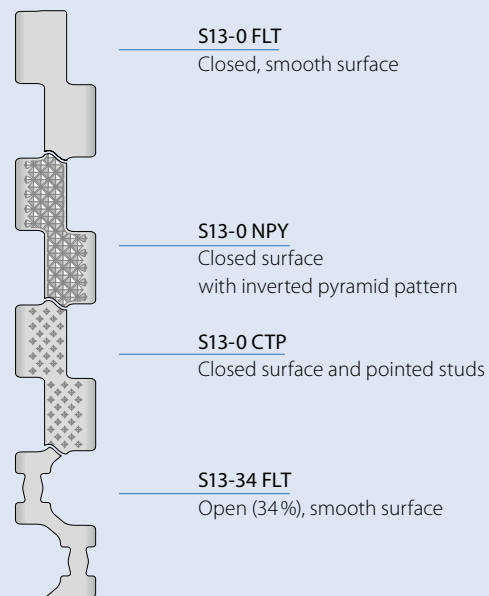

Sprockets and ProSnap Quick-Release available in different sizes and designs

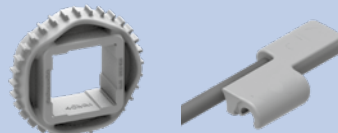

¹⁾ NSF-compliant from these certified Forbo plants: Huntersville (USA), Malacky (Slovakia), Tlalnepantla (Mexico)

Straight running belts

Series 14 | Pitch 12.7 mm (0.50 in)

Belts for medium-duty food and non-food applications

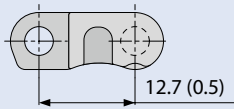

Design characteristics

- Mini pitch belt with small transfer gap
- Robust design guarantees superior durability and high belt pull capacity
- Design for smooth run on 19 mm (0.75 in) nose bar
- Headless pin system, making it easy to install and remove the belt for maintenance
- Closed, solid belt edge to prevent belt edge damages

Available surface pattern and opening area

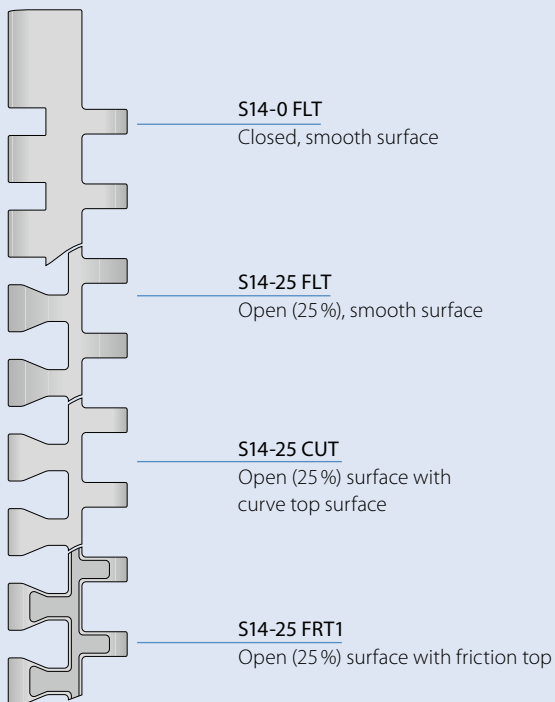

Sprockets and profiles available in different sizes and designs

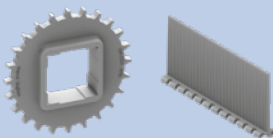

Series 15 | Pitch 12.7 mm (0.50 in)

Belts for light-duty food applications utilizing 12.7 mm (0.5 in) nose bars

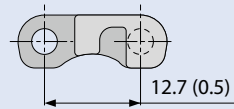

Design characteristics

- Mini-pitch belt with large open area for optimum airflow
- Scalloped underside facilitates smooth product transfer over a 12.7 mm (0.5 in) diameter nose bar.
- Open hinge for improved sanitation
- Narrow 25 mm (1 in) width increments offer superior support of conveyed products
- Solid and robust edge design incorporating improved pin retention
- Headless one-piece pin for easy installation and removal
- Sprockets with large solid tooth insures superior load transmission and long wear life

Available surface pattern and opening area

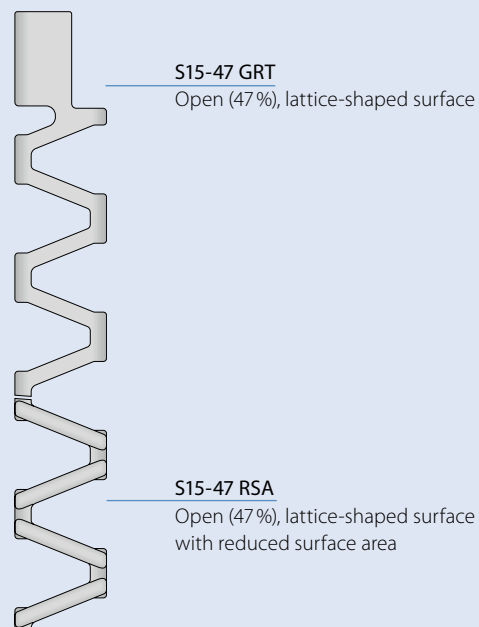

Sprockets available in different sizes and designs



Series 17 | Pitch 25.4 mm (1 in)

Belts for medium to heavy-duty applications

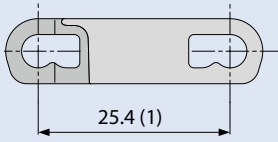

Design characteristics

- Closed hinge design provides high belt pull capacity
- A rigid module design allows optimal utilization of belt pull capacity relative to belt weight
- Robust design guarantees durability
- Unique 'keyhole' pin retention system ensures easy pin removal

Available surface pattern and opening area

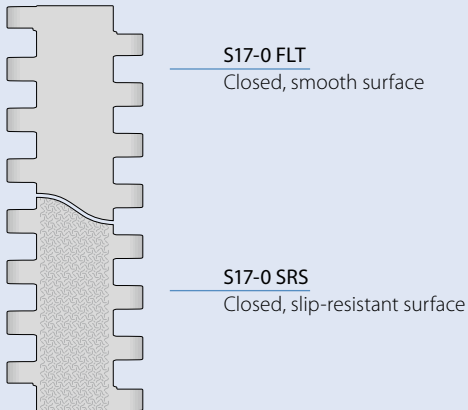

Sprockets and profiles available in different sizes and designs

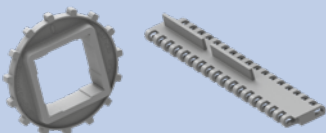

Series 19 | Pitch 63.5 mm (2.5 in)

Belts for heavy-duty applications

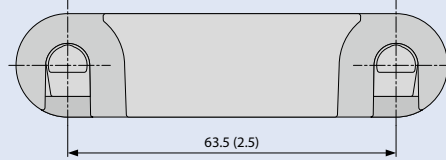

Design characteristics

- Extreme heavy-duty belt for high load applications and smooth running condition
- Reinforcement links and low wear inserts can be integrated as desired
- Robust design with large surface contact area and strong sprocket design ensures superior wear life
- Flame retardant (complies with DIN EN 135011 Bfl-S1) and highly conductive (surface resistivity $< 10^6 \Omega$)

Available surface pattern and opening area

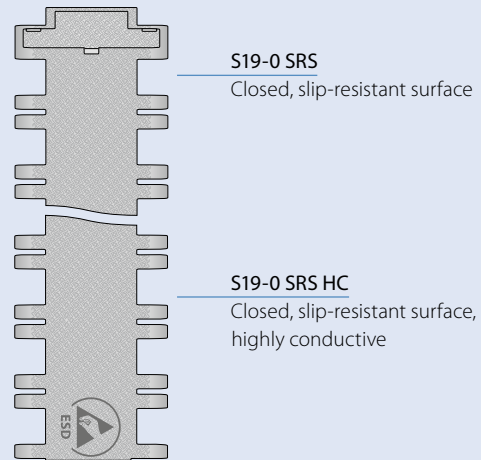

Sprockets and wheelstoppers available in different sizes and designs

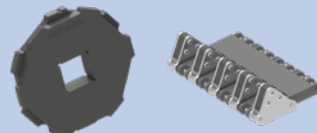

Side flexing and spiral belts

Series 5 | Pitch 25 mm (0.98 in) | $C_c = 2.0$

Belts for light to medium-duty food and non-food applications

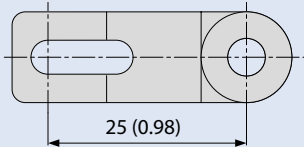

Design characteristics

- Suitable for both straight and radius conveying
- Up to 45 % open area for excellent air circulation and drainage
- Stainless steel hinge pins for high load capacity, lateral stiffness, fewer belt supports and minimum belt lifting in curves
- No potential belt edge catch points due to safe fixing of hinge pins
- The combination S5 ST/S11-45 GRT ensures high belt pull capacity and small radii (C_c 1.45) in one directional curve layouts

Available surface pattern and opening area

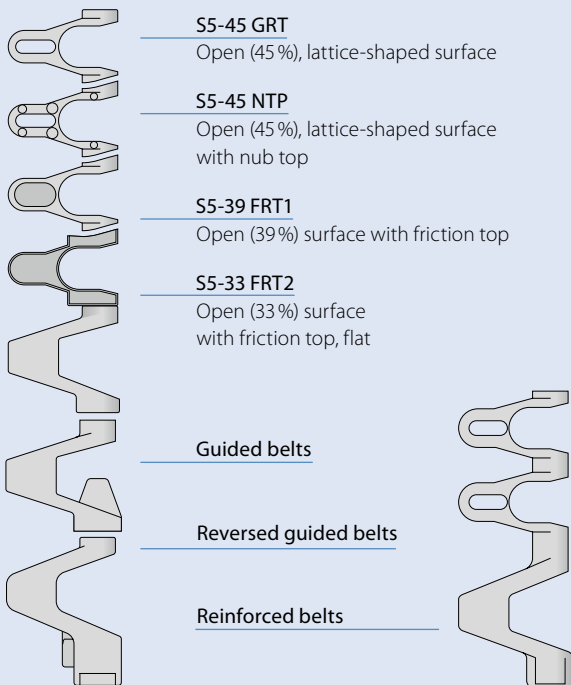

Sprockets, profiles, side guards and ball-bearing modules available in different sizes and designs



Series 9 | Pitch 50 mm (1.97 in) | $C_c = 1.8$

Belts for medium to heavy-duty food and non-food applications

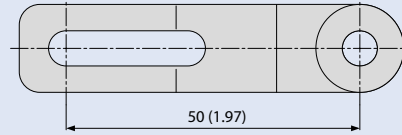

Design characteristics

- Suitable for both straight and radius conveying
- 57 % open area for excellent air circulation and drainage
- Stainless steel hinge pins for high load capacity, lateral stiffness, fewer belt supports and minimum belt lifting in curves
- No potential belt edge catch points due to safe fixing of hinge pin

Available surface pattern and opening area

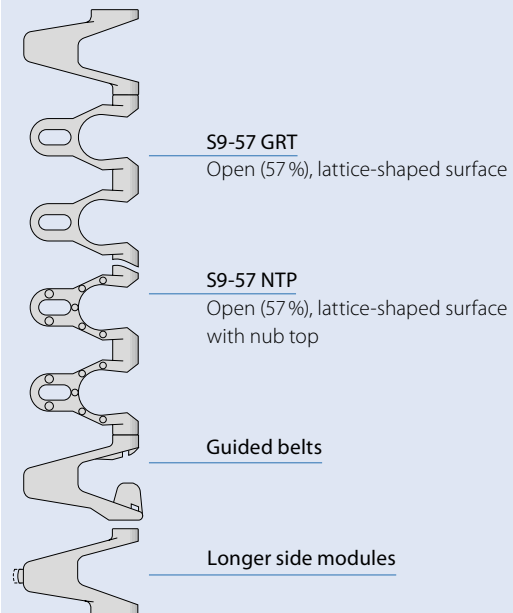

Sprockets, profiles, side guards and self stacker available in different sizes and designs

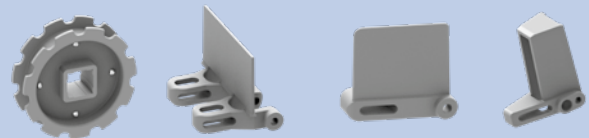

Series 9.1 | Pitch 50 mm (1.97 in) | $C_c = 1.3 - 2.9$

Belts for medium to heavy-duty food and non-food applications

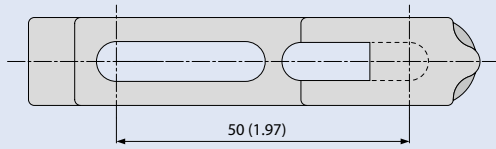

Design characteristics

- Can be used in spiral towers with cage drives and for straight and radius conveying
- Strong side modules in a brick-laid pattern for exceptional tensile load
- Hinge pins with clip-free attachment
- Stainless steel hinge pins for high load capacity, lateral stiffness, less belt supports and minimum belt lifting in curves
- Adjustable collapse factor of 1.3 - 2.9

Available surface pattern and opening area

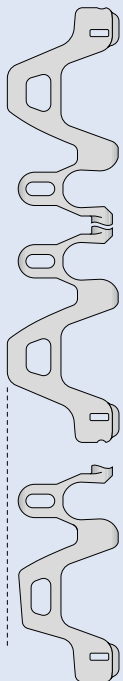

S9.1-57 GRT SMU
Open area (57%), with grid top

S9.1-57 GRT SMT
Open area (57%), grid top
Can be used on the inner radius to decrease the collapse factor

Sprockets available in different sizes and designs

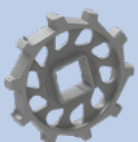

Series 11 | Pitch 25 mm (0.98 in) | $C_c = 1.4$

Belts for light-duty food and non-food applications

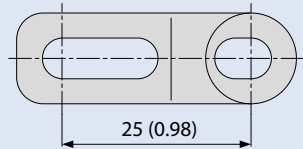

Design characteristics

- 45% open area provides excellent cooling and draining capabilities
- All plastic lightweight belts (plastic pins)
- Tight radius belt with minimum curve radius of 1.4 x belt width
- Outermost hinge is fixed to the pin to prevent deflection and elimination of potential belt edge catch points
- Suitable for both straight and radius conveying
- Ideal transmission of force due to sprockets offset inwards. Idlers support the belt on the outside

Available surface pattern and opening area



S11-45 GRT
Open (45%), lattice-shaped surface with replaceable caps

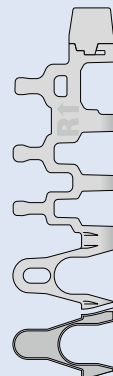

S11-45 GRT HD
Open (45%), lattice-shaped surface with replaceable Hold Down caps

S11-33 FRT2
Open (33% for full FRT2 surface area), surface with friction top, flat

Sprockets/idlers and profiles available in different sizes and designs



¹⁾ NSF-compliant from these certified Forbo plants: Huntersville (USA), Malacky (Slovakia), Tlalnepantla (Mexico)

Side flexing and spiral belts

Series 18 | Pitch 25.4 mm (1 in) | $C_c = 1.7/2.2$

Belts for light to medium-duty food and non-food applications

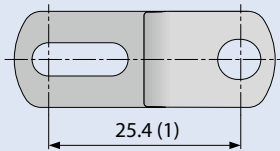

Design characteristics

- 44 % open all plastic light weight belt suitable for both straight and radius conveying
- Grid structure for handling of small products
- High curve belt pull capacity
- Easy to clean belt for direct food contact
- Superior lateral stiffness and rigidity for an all-plastic belt

Available surface pattern and opening area

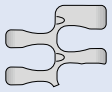

S18-44 GRT (CW/CCW) 2.2
Open (44 %), lattice-shaped surface

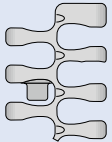

S18-44 GRT (CW/CCW) 2.2 G
Open (44 %), lattice-shaped surface and Hold Down Tabs

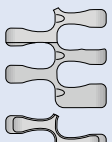

S18-44 HDK (CW/CCW) 2.2
Open (44 %), lattice-shaped surface and High Deck

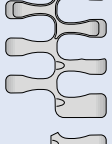

S18-44 FRT1 (CW/CCW) 2.2
Open (44 %), lattice-shaped surface with friction top



S18-44 GRT (CW/CCW) 1.7
Open (44 %), lattice-shaped surface

S18-44 GRT CW 2.2/1.7
S18-44 GRT CCW 1.7/2.2
Open (44 %), lattice-shaped surface
CW = Clockwise (right hand curve)
CCW = Counter Clockwise (left hand curve)
(picture shows CCW)

Sprockets, profiles and side guards available in different sizes and designs

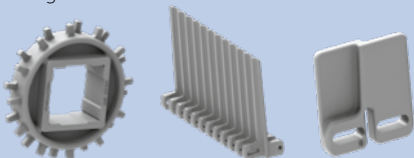

¹⁾ NSF-compliant from these certified Forbo plants: Huntersville (USA), Malacky (Slovakia), Tlalnepantla (Mexico)

Available surface pattern and belt openings

Available surfaces for each series

Surface pattern	Series																		
	1	2	4.1	5	6.1	7	8	8.1	9	9.1	10	11	13	14	15	17	18	19	
CTP (Cone top)					●								●				●		
CUT (Curved top)														●					
FLT (Flat top)	●	●	●		●	●		●			●		●	●		●			
FRT (Friction top)	●	●	●	●	●	●	●				●	●		●			●		
GRT (Grid top)		●		●					●	●		●			●		●		
GRT G (Grid top guided)				●					●								●		
GRT RG (Grid top reverse guided)				●														●	
GRT HD (Grid top Hold Down caps)												●							
GRT ST (Grid top strong)				●															
HDK (High Deck)																		●	
LRB (Lateral rib)											●								
NPY (Negative pyramid)			●										●						
NSK (Non skid)	●					●		●											
NTP (Nub top)			●	●	●				●		●								
RAT (Radius top)								●											
RRB (Raised rib)		●																	
RSA (Reduced surface area)															●				
SRS (Slip-resistant surface)	●					●		●								●		●	
RTP (Roller top)							●												

Available open percentage for each series

Belt opening	Series																		
	1	2	4.1	5	6.1	7	8	8.1	9	9.1	10	11	13	14	15	17	18	19	
0% (Closed)	●	●	●		●	●	●	●			●		●	●		●		●	
1% – 10%						●													
11% – 20%	●	●																	
21% – 30%			●		●			●			●			●					
31% – 40%				●	●						●	●	●						
> 40%		●		●					●	●		●			●		●		

The percentage indicates the relation of bright area to shadow, if the module is beamed with light

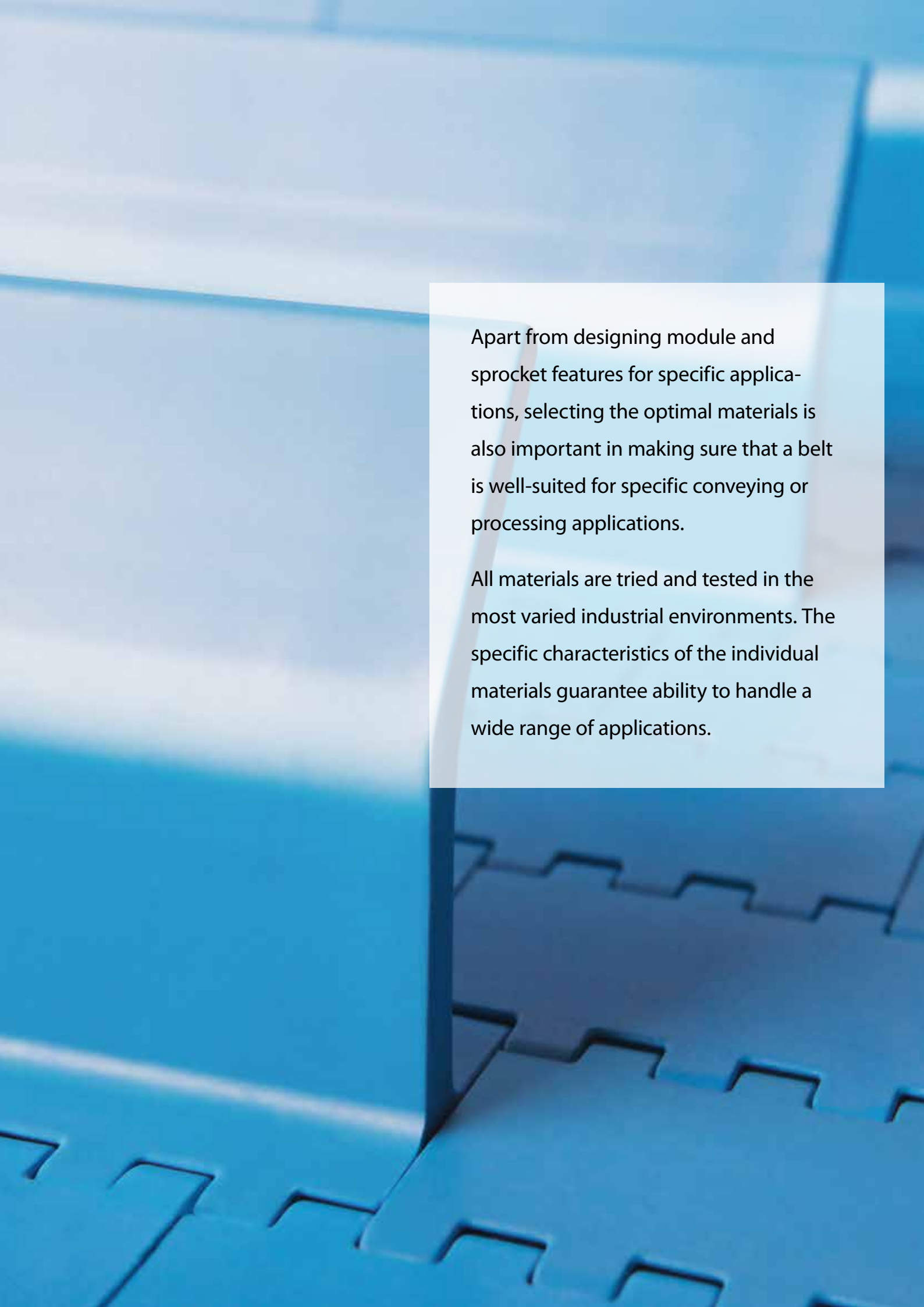
A close-up photograph of a blue conveyor belt with a white text box overlaid on the right side. The belt has a series of rectangular teeth or sprockets. The background is a blurred blue surface.

Apart from designing module and sprocket features for specific applications, selecting the optimal materials is also important in making sure that a belt is well-suited for specific conveying or processing applications.

All materials are tried and tested in the most varied industrial environments. The specific characteristics of the individual materials guarantee ability to handle a wide range of applications.

SIEGLING PROLINK MATERIALS AND PROPERTIES

Materials

PA	=	Polyamide	PP	=	Polypropylene
PA-FR	=	PA flame retardant	PP-MD	=	PP metal detectable
PA-FRHHC	=	PA flame retardant, highly conductive	PP-SW	=	PP steam and hot water resistant
PA-HT	=	PA high temperature resistant	PK	=	Wear and impact improved polymer
PBT	=	Polybutylene terephthalate	PLX	=	Special PK for pins with small diameter – higher stiffness
PE	=	Polyethylene	PXX-HC	=	PXX self-extinguishing, highly conductive
PE-I	=	PE impact resistant	TPC1	=	Thermoplastic copolyester
PE-MD	=	PE metal detectable			
POM	=	Polyoxymethylene/Polyacetal			
POM-CR	=	POM cut resistant			
POM-HC	=	POM highly conductive			
POM-MD	=	POM metal detectable			
HW	=	POM highly wear resistant			

Use of materials

Application environment		Belt modules	Pins
General conveying	General conveyor (> 10 °C / > 50 °F)	PP	PP
	Aggressive chemicals (strong acid etc.)	PP	PP
	Impact and/or low temperature (<10 °C / <50 °F)	PE (PE-I)	PE
	High load	POM	PBT
Abrasive	Deboning and trimming	POM-CR	PBT
	Dip tank conveyor (PAA)	PK (PLX)	PK (PLX)
	Wet, light load (Temperature <50 °C (122 °F))	PP	PBT
	Wet, high load (Temperature <50 °C (122 °F))	POM	PBT
	Dry	POM	PBT
Increased temperature	Boiling and steaming, up to 100 °C (212 °F)	PP-SW	PP-SW
	Dry, high load up to 90 °C (194 °F)	POM	PBT
	Wet, high load up to 90 °C (194 °F)	POM	POM
	Dry up to 120 °C (248 °F), FDA/EU	PA	PBT
	Dry up to 155 °C (311 °F), not FDA/EU	PA-HT	PA-HT

Belt material orientation chart

Every material has a unique combination of strengths. The following table provides an overview of all Siegling Prolink materials and their properties rated from 1 (bad) to 10 (good).

	Belt pull capacity	Impact strength	Wear resistance (high value = low dusting)	High temperature	Low temperature	Price	Direct food contact	Submerged in water	Metal detectable	Antistatic	Flame retardant	Suitable for micro- wave applications
PA	8	4	8	8	6	7	Yes	No	No	No	Yes	No
PA-HT	7	6	9	9	5	6	Yes**	No	No	No	No	No
PE	2	8	2	3	9	9	Yes	Yes	No	No	No	Yes
PE-I	2	9	2	3	9	9	Yes	Yes	No	No	No	No
PE-MD	2	7	2	3	9	6	Yes	Yes	Yes	No	No	No
PK (PLX)	5	9	9	8	7	3	Yes	Yes	No	No	No	No
POM	8	4	7	6	7	7	Yes	Yes	No	No	No	No
POM-CR	8	6	7	6	7	7	Yes	Yes	No	No	No	No
POM-HC	7	3	7	6	7	4	No	Yes	No	Yes	No	No
POM-MD	7	3	7	6	7	2	Yes	Yes	Yes	No	No	No
PP	4	3	3	7	3	9	Yes	Yes	No	No	No	Yes
PP-MD	4	2	3	7	3	8	Yes	Yes	Yes	No	No	No
PP-SW	3	4	3	8	3	8	Yes	Yes	No	No	No	No
PXX-HC	4	3	3	7	3	4	No	Yes	No	Yes	Yes	No
TPC1	2	10	10*	5	5	2	Yes	Yes	No	No	No	No

* for applications in abrasive particles, ** only in BL (blue)

Friction factors

The dynamic coefficients of friction μ_s between belt and wearstrip are shown below.

The figures stated have been established under ideal conditions. When operating under other conditions we recommend assuming higher friction coefficients. ("—" = combination not recommended, empty cell = combination not tested)

Wearstrip material	Operating conditions	Belt material																				
		PA			PA-HT			PE & PE-MD			POM incl. CR, HC & MD			PP, PP-MD & PXX-HC			PK (PLX)			TPC1		
		clean	regular	soiled	clean	regular	soiled	clean	regular	soiled	clean	regular	soiled	clean	regular	soiled	clean	regular	soiled	clean	regular	soiled
Hardwood	dry	0.18	0.19	0.29	0.14	0.14	0.14	0.16	0.16	0.24	0.16	0.22	0.32	0.22	0.39	0.59						
	wet	-	-	-	-	-	-	-	-	-	-	-	-	-	-	-						
PE-HMW	dry	0.15	0.23	0.34	0.12	0.2	0.31	-	-	-	0.08	0.19	0.29	0.14	0.19	0.29						
	wet	-	-	-	-	-	-	-	-	-	0.08	0.12	0.25	0.12	0.17	0.26						
Lubricated PA	dry	0.16	0.24	0.36	0.14	0.22	0.32	0.18	0.28	0.45	0.12	0.20	0.30	0.13	0.24	0.35						
	wet	-	-	-	-	-	-	-	-	-	-	-	-	-	-	-						
Steel	dry	0.20	0.31	0.45	0.19	0.25	0.38	0.14	0.23	0.38	0.18	0.23	0.35	0.25	0.31	0.47	0.24	0.28	0.32	0.40	0.46	0.61
	wet	-	-	-	-	-	-	0.13	0.21	0.33	0.14	0.17	0.26	0.24	0.29	0.44	0.21	0.26	0.30	0.38	0.44	0.59
UHMW PE	dry	0.18	0.24	0.38	0.15	0.19	0.35	0.30	0.31	0.47	0.13	0.17	0.32	0.13	0.22	0.35	0.21	0.25	0.29	0.43	0.49	0.65
	wet	-	-	-	-	-	-	0.27	0.28	0.45	0.11	0.15	0.28	0.11	0.20	0.32	0.10	0.18	0.23	0.39	0.46	0.62

Temperature ranges

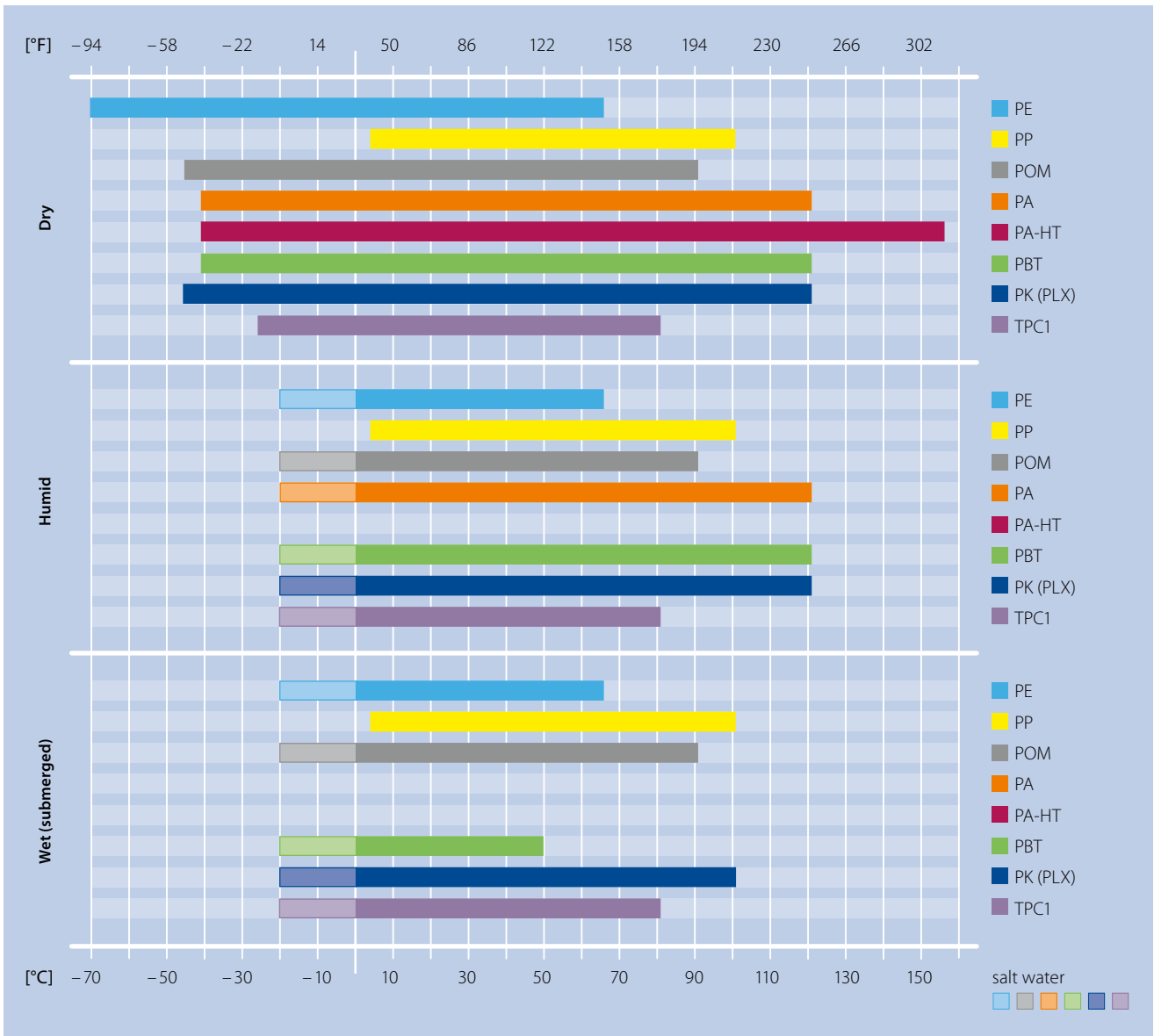

FIRE WARNING for Siegling Prolink plastic modular belts

Siegling Prolink belts are made of various high-quality plastic materials that can burn. If ignited, products made from POM material will emit toxic fumes. During operation, storage and installation NEVER expose Siegling Prolink belts to an ignition source, such as flames, sparks, burning or very hot objects, or excessive heat. Special care should be taken when undertaking repair work, particularly when welding on or near a conveyor if the conveyor is equipped with a Siegling Prolink plastic modular belt.

Hazards from burning Siegling Prolink belts vary depending on material composition and environmental conditions

such as temperature and oxygen availability. Hazards may include dense smoke, toxic gases or fumes, a flame that is difficult to detect, and fire spreading due to movement of the burning belt and/or dripping, burning, molten plastic.

Suitable fire extinguishing media include: water spray, foam, and dry chemical.



Declaration of compliance

FDA/EU

Siegling Prolink modular belts made of the following materials are proven to comply with FDA 21 CFR as well as the (EU) 10/2011 and (EC) 1935/2004 regulations regarding the raw materials used and the migration thresholds:

	BL	BG	BK	DB	LB	LG	OR	UC	WT	Colors*
PA	●					●				BL = Blue
PA-HT	●									BG = Beige
PBT	●				●			●		BK = Black
PE	●		●	●	●	●	●	●	●	DB = Dark blue
PE-I								●		LB = Light blue
PE-MD	●									LG = Light gray
PK (PLX)	●							●		OR = Orange
POM	●			●	●	●	●	●	●	UC = Uncolored
POM-CR	●			●	●	●	●	●	●	WT = White
POM-MD	●									
PP	●			●	●	●	●	●	●	
PP-MD	●									
PP-SW	●				●				●	
TPC1					●			●	●	
TPE R7*	●	●	●							
TPE R8*		●								

* Please refer to the table for each series' standard colours. A number of other colors are available on request. Colors can vary from the original due to the print, production processes or material used.

* Do not use in direct contact with fatty foods

MHLW

Siegling Prolink modular belts made of the following materials comply with Japanese Food Regulation (Ministry of Health and Welfare #370).

	BL	BG	BK	DB	LB	LG	OR	UC	WT
PA	●					●			
PA-HT	●								
PBT	●				●			●	
PE	●		●	●	●	●		●	●
PE-I								●	
PE-MD	●								
PK (PLX)	●							●	
POM	●			●	●	●		●	●
POM-CR	●			●	●	●		●	●
POM-MD	●								
PP	●			●	●	●		●	●
PP-MD	●								
PP-SW	●				●				●
TPC1					●	●		●	●

Halal

All Siegling POM Prolink modular belts are certified as being compliant with Halal regulations by IFRC Asia (member of the World Halal Council).

HACCP requirements

Regulatory requirements are forcing food manufacturers to adopt stringent hygiene standards and sanitation procedures. Conventional conveyor and processing belts often cannot comply with these requirements, but Siegling Prolink modular belts are designed to effectively support your HACCP concept.

Prolink plastic modular belts offer built-in hygiene thanks to fully closed surfaces and homogenous materials that are EU-, FDA-, MHLW and NSF-approved. Series 4.1, 6.1, 10, 13 and 15 in particular support your HACCP concept with further hygiene-friendly characteristics.

- Easy-clean design with wide channels on the bottom of the modules
- Easy-to-clean sprocket design
- Excellent resistance to hydrolysis
- Good release properties
- They come in blue as a strong color contrast

Fewer areas where contamination can occur

Large radii, smooth, rounded sprocket surfaces, wide hinge eyelets and perfectly fitted hinge pins don't leave contamination and soiling to chance. (Figure: Prolink series 6.1)

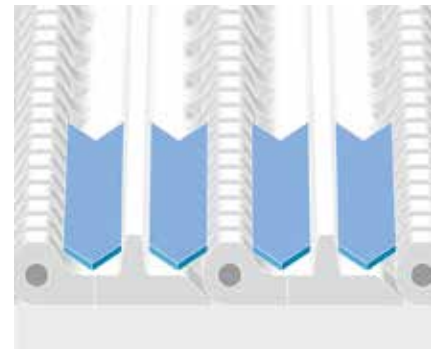
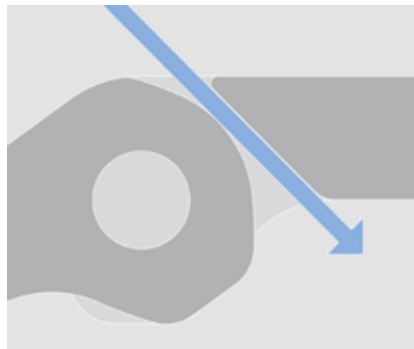
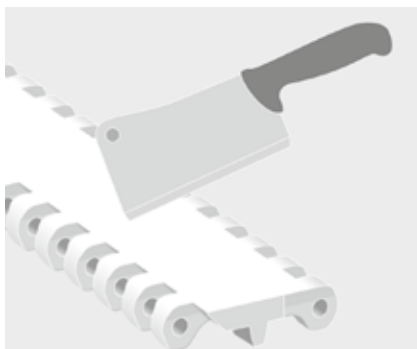
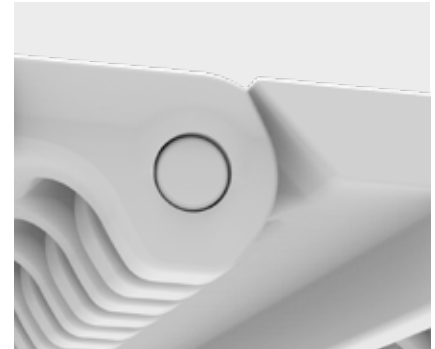
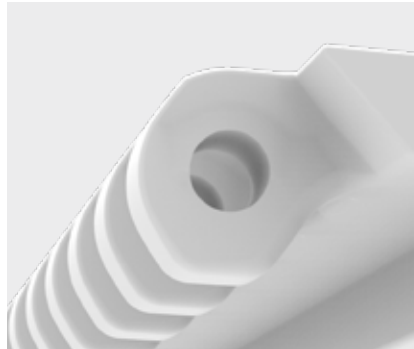

Incision-proof surfaces

POM-CR modules are exceptionally incision-proof and resistant to impact. This minimizes the risk of grooves forming and delamination. (Figure: Prolink series 6.1)

Quick and easy to clean

On the returns, the lengthways and crosswise hinges provide openings for rinsing. On the underside, continuous channels without any annoying ribs make cleaning effective. (Figure: Prolink series 6.1)

Siegling – total belting solutions

Committed staff, quality oriented organization and production processes ensure the constantly high standards of our products and services.

Forbo Movement Systems complies with total quality management principles. Our quality management system has ISO 9001 certification at all production and fabrication sites. What's more, many sites have ISO 14001 environmental management certification.



Ref. no. 800-2
05/26-UDH- Reproduction of text or parts thereof only with our approval. Subject to change.



Our service – anytime, anywhere

Forbo Movement Systems employs around 2,300 people in its group of companies. Our products are manufactured in ten production facilities across the world.

You can find companies and agencies with warehouses and workshops in over 80 countries.

Service points are located in more than 300 places worldwide.

Forbo Siegling GmbH

Lilienthalstrasse 6/8, D-30179 Hannover

Phone +49 511 6704 0

www.forbo-siegling.com, siegling@forbo.com



MOVEMENT SYSTEMS