

ROLLON[®]
BY TIMKEN

Linear Line

Telescopic Line

Actuator Line

Actuator System Line



Soluzioni lineari per interni ed architettura
Linear solutions for interiors and architecture

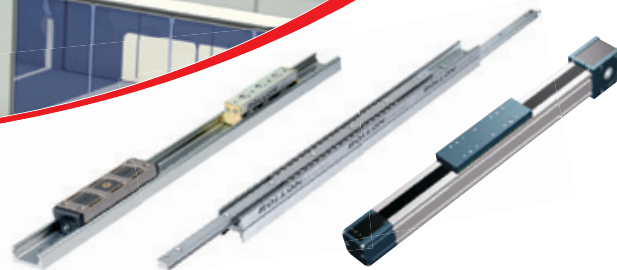

**Con voi, in movimento
When you move, we move**

ROLLON è un Gruppo internazionale che opera dal 1975 sul mercato della movimentazione lineare industriale. ROLLON vuole essere per i suoi Clienti "l'idea" che aiuta a semplificare le loro attività, fornendo soluzioni che permettono di soddisfare le più svariate esigenze, con una produzione efficiente e a costi competitivi, in grado di personalizzare il prodotto in funzione dell'applicazione, tanto da renderlo se necessario "unico per ciascun Cliente".

ROLLON has been a leading international linear motion manufacturer since 1975 providing linear bearings, actuators and linear motion products that surpass the needs of its industrial customer base. ROLLON's family of products provides high quality, cost-effective answers to standardized industry requirements. The biggest added value is given by the ability to personalize the product according to the application so that if needed, the product becomes "unique for each customer".

ROLLON[®]
BY TIMKEN

fashion

> Estrazione a sbalzo espositore
Display case slide out

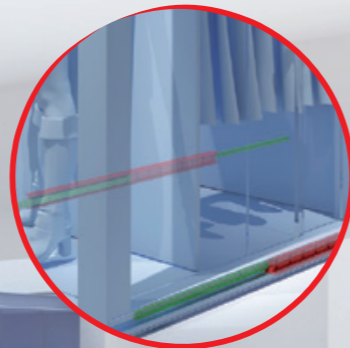

> Estrazione cassette per negozi di lusso
Drawer slide out for luxury shop

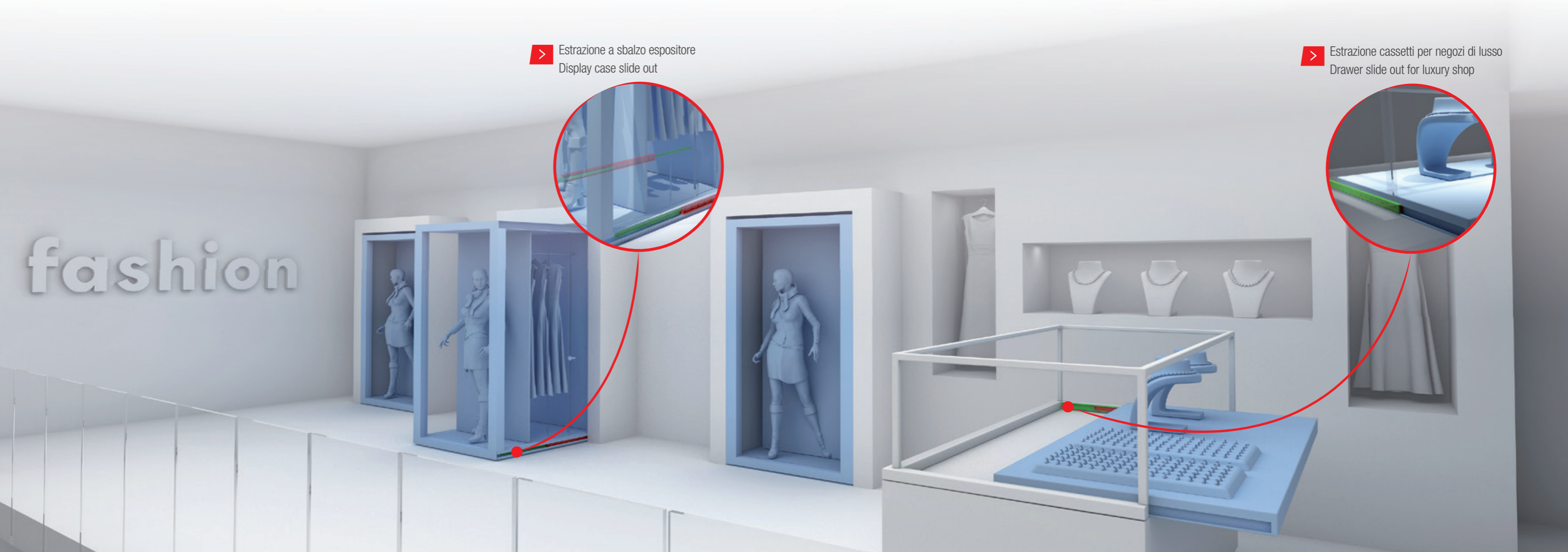
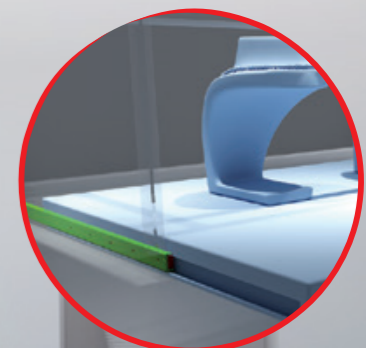

> Apertura scorrevole vetrina dei vini
Door slide for wine cooler

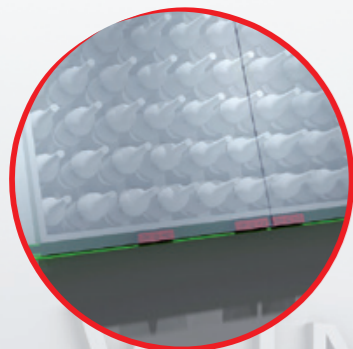

> Apertura espositori banco frigo
Sliding display case

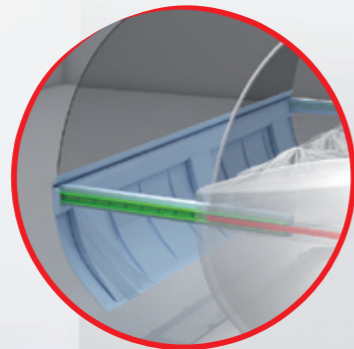

> Movimentazione banco cassa per supermercato
Sliding counter for modular cash desk

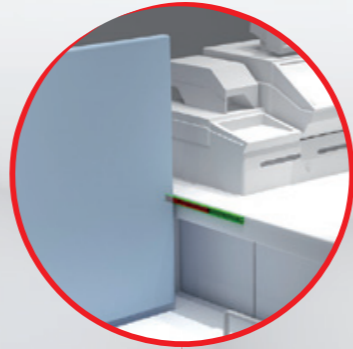

> Porta scorrevole per banco frigo
Sliding refrigerator door

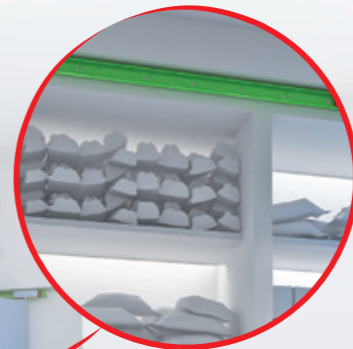

> Apertura scorrevole espositore alimentari
Sliding food display case

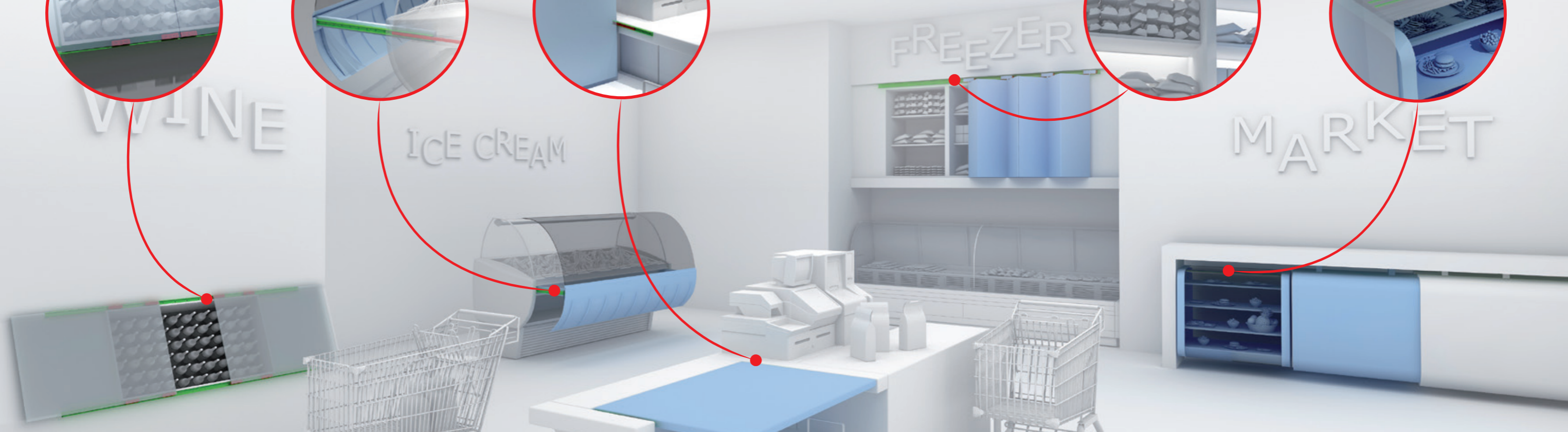
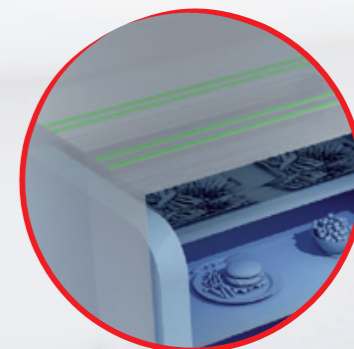

> Estrazione piano vetrina
Horizontal display slide

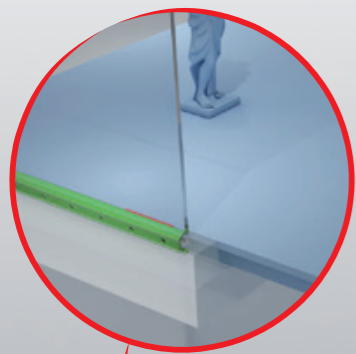

> Estrazione espositore
Display case slide out

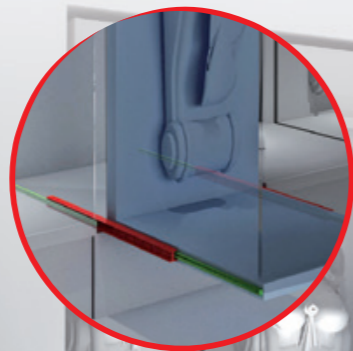

> Scorrimento verticale vetrina
Vertical display slide

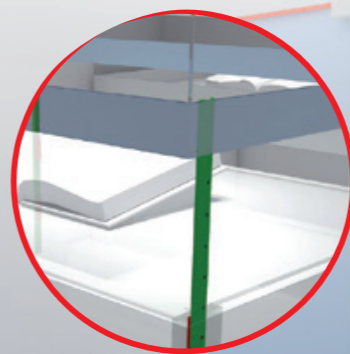

> Apertura scorrevole vetrina
Sliding door system

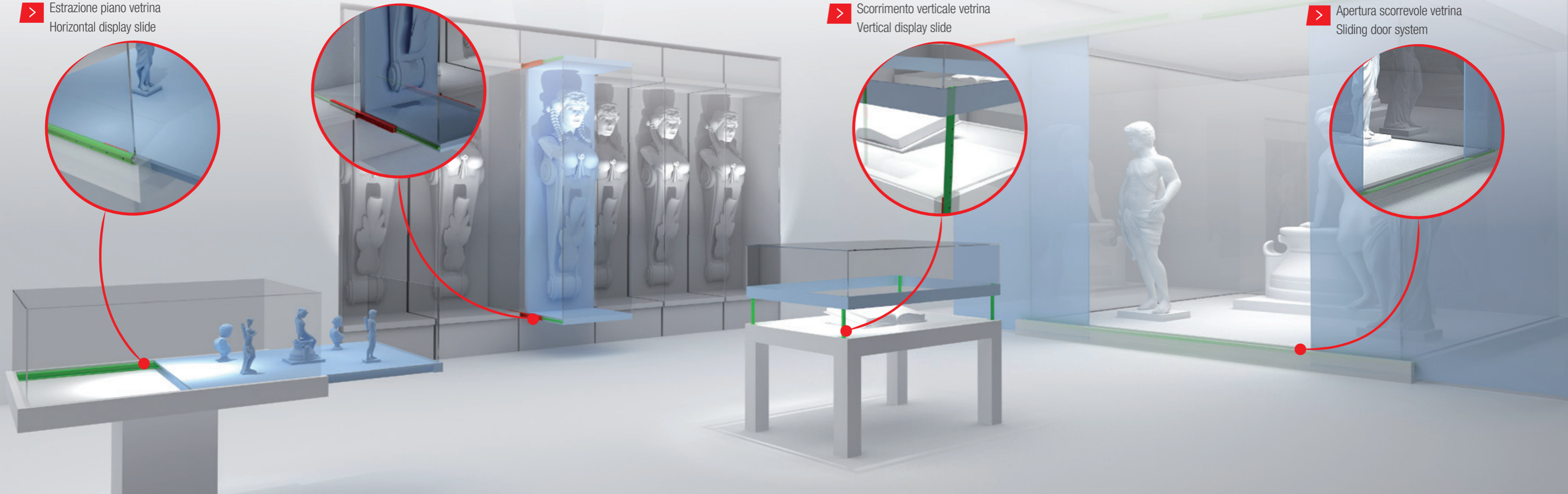
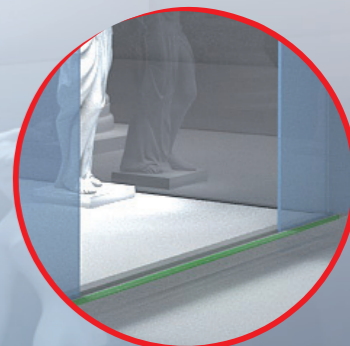

> Apertura circolare per reception
Circular opening access for reception desk

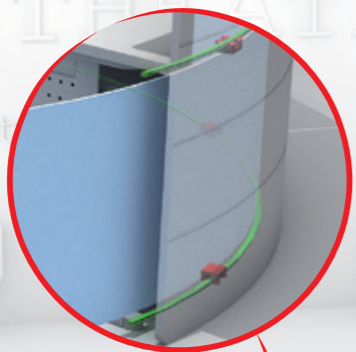

> Estrazione moduli server
Server rack slide out



> Movimentazione videocamera
Camera dolly

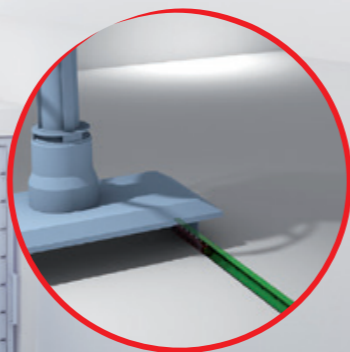

> Sistema di scorrimento poltrone
Chair slide system

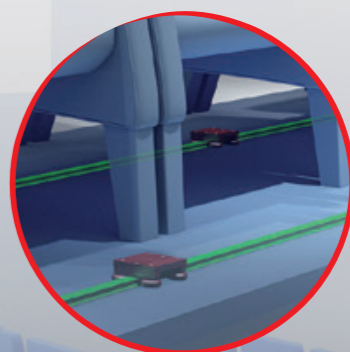
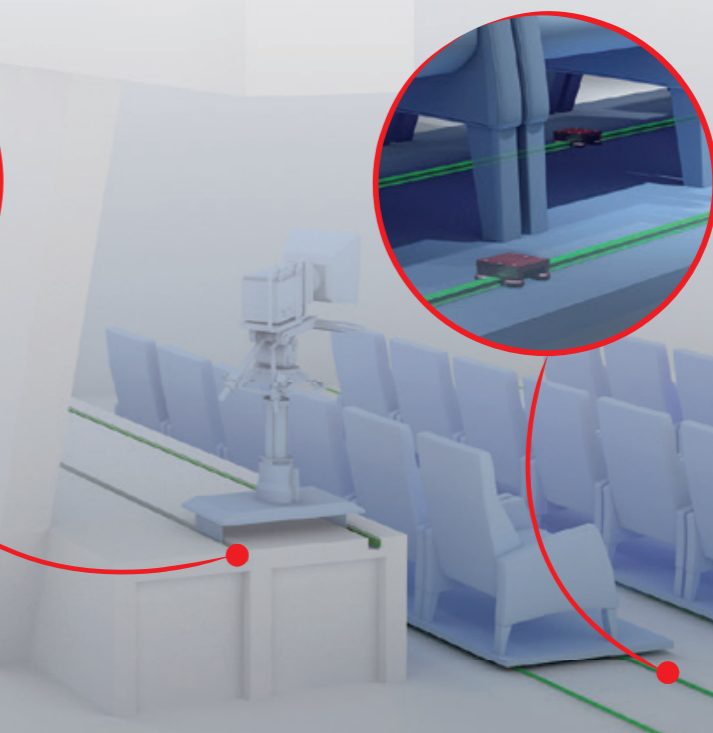
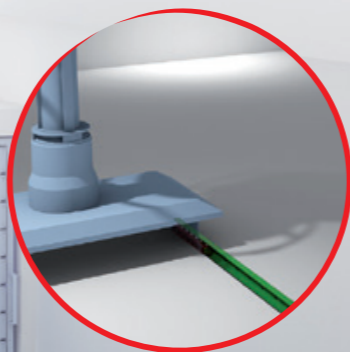
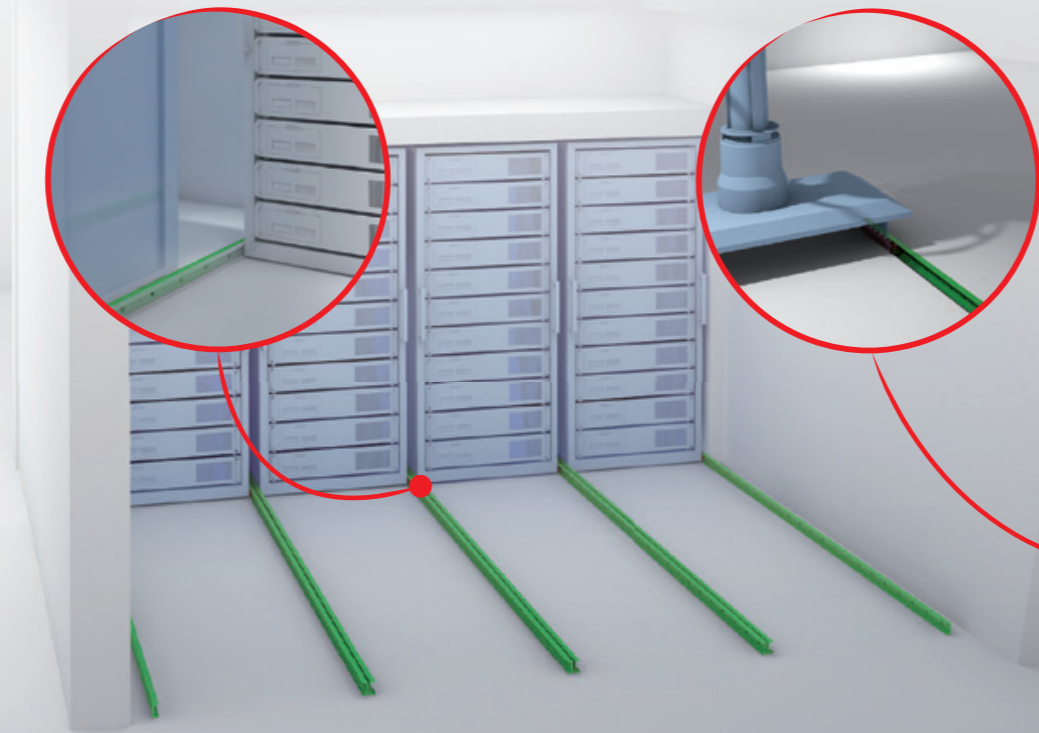
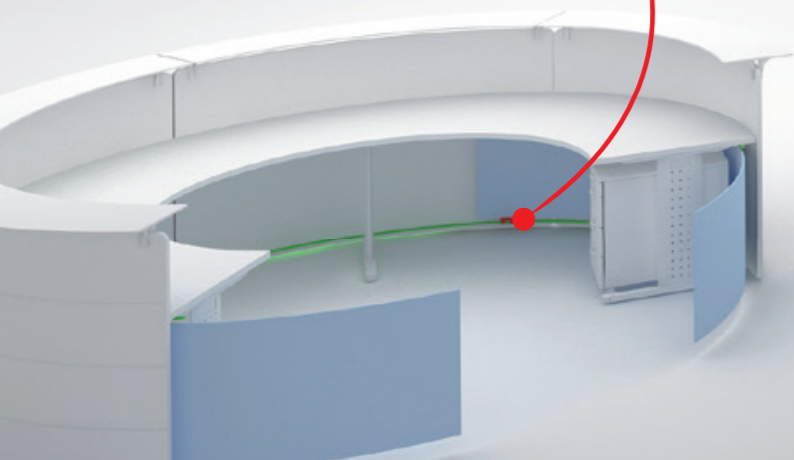
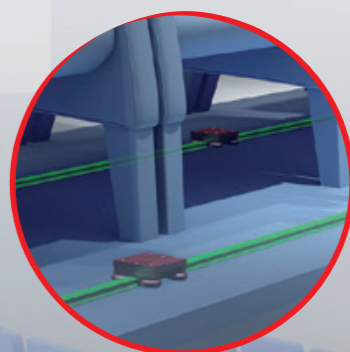

> Estrazione acquario
Wall aquarium slide out

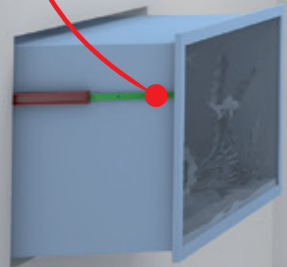
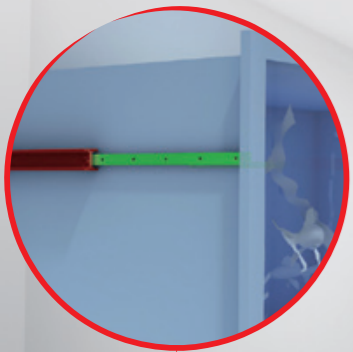

> Sistema apertura/chiusura camino
Fireplace opening/closing system

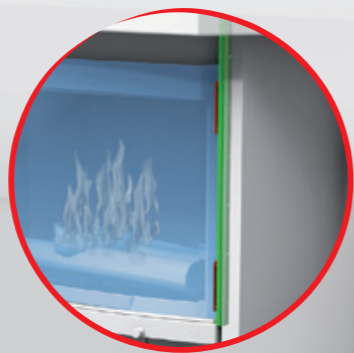

> Piano cucina scorrevole
Sliding kitchen counter

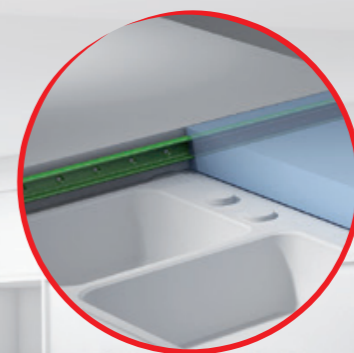

> Porta armadio scorrevole
Wardrobe sliding unit

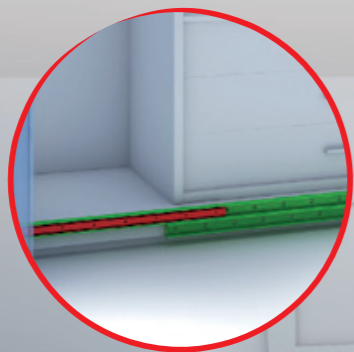

> Rotazione letto circolare
Circular bed rotation

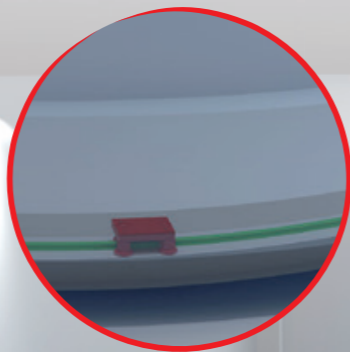

> Letto scorrevole
Bed slide system

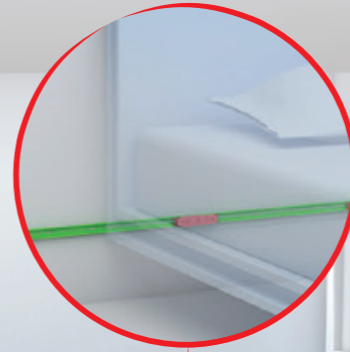

> Porta scorrevole box doccia
Shower door slide system

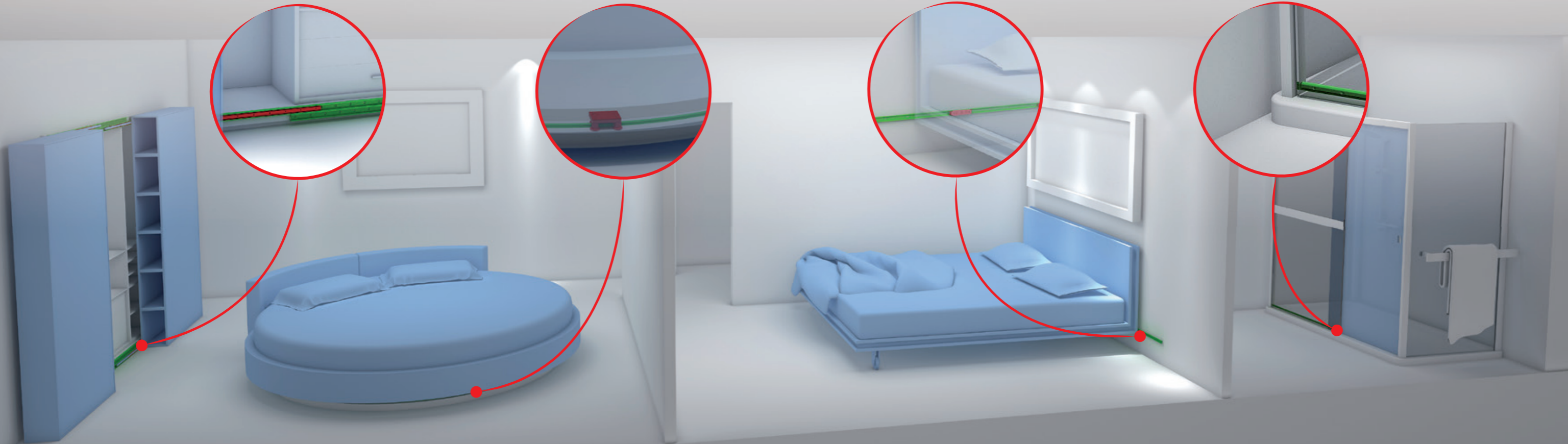

> Sistema di apertura porta ascensore
Elevator door slide

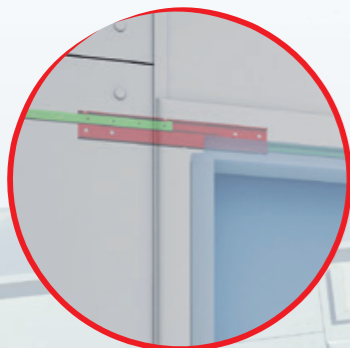

> Scorrimento barriera di protezione
Vertical sliding foot guard

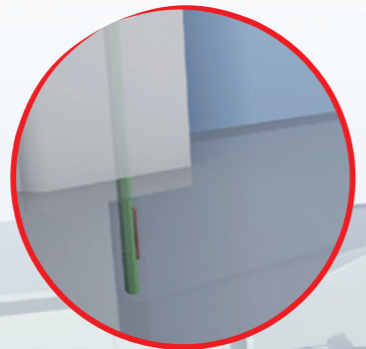

> Apertura finestra scorrevole
Sliding window

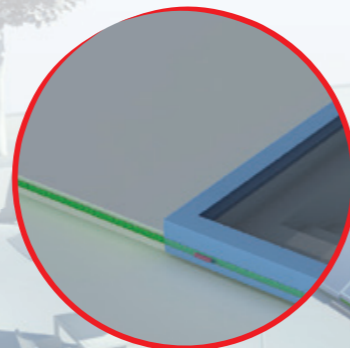

> Movimentazione copertura per piscina
Sliding pool cover

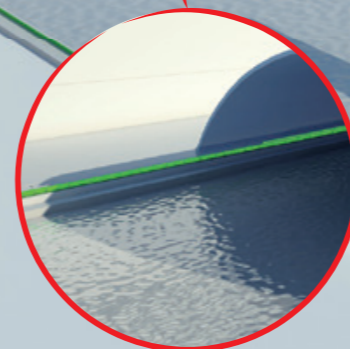

> Movimentazione copertura per piscina
Sliding pool cover

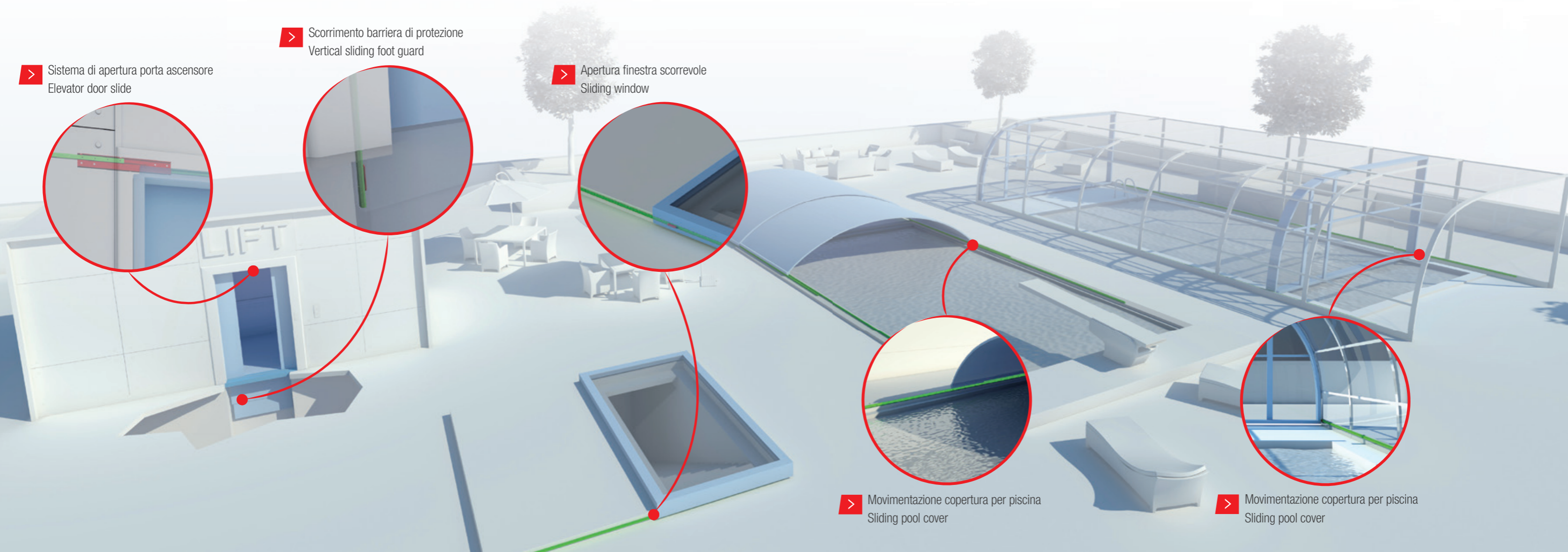
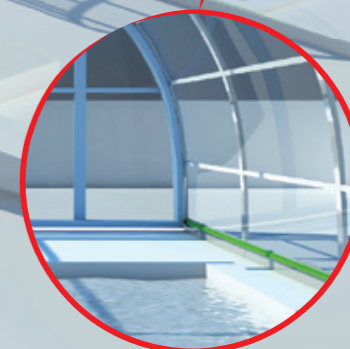



Guide lineari e curvilinee a sfere e a cuscinetti.
Linear and curved guides with ball and roller bearings.

Linear Line

Telescopic Line

Guide telescopiche a sfere
Telescopic guides with ball bearings

Una gamma completa per il linear motion che raggiunge ogni cliente

A complete range for linear motion which reaches every customer

Un global provider di soluzioni per applicazioni di moto lineare
A global provider of solutions for applications for linear motion

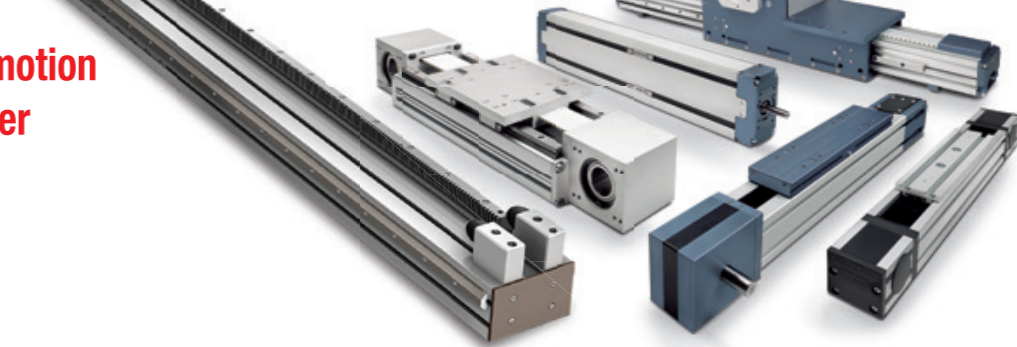

Attuatori lineari con differenti configurazioni di guide e azionamenti.
Linear actuators with different guide configurations and drives.

Actuator Line



Actuator System Line

Sistemi speciali multi-asse per automazioni industriali.
Special multiple axis systems for industrial automation.

Soluzioni lineari per ogni applicazione

Linear solutions for every application

Notes • Note



ROLLON
BY TIMKEN

- Linear Line
- Telescopic Line
- Actuator Line
- Actuator System Line

Soluzioni lineari per macchine industriali
Linear solutions for industrial machines

ROLLON
BY TIMKEN

- Linear Line
- Telescopic Line
- Actuator Line
- Actuator System Line

Linear solutions for packaging and logistic applications
Soluzioni lineari per applicazioni nel packaging e nella logistica

ROLLON
BY TIMKEN

- Linear Line
- Telescopic Line
- Actuator Line
- Actuator System Line

Soluzioni lineari per applicazioni ferroviarie
Linear solutions for railway applications

ROLLON
BY TIMKEN

- Linear Line
- Telescopic Line
- Actuator Line
- Actuator System Line

Soluzioni lineari per applicazioni aeronautiche
Linear solutions for aircraft applications

ROLLON
BY TIMKEN

- Linear Line
- Telescopic Line
- Actuator Line
- Actuator System Line

Soluzioni lineari per veicoli speciali
Linear solutions for special vehicles applications

ROLLON
BY TIMKEN

- Linear Line
- Telescopic Line
- Actuator Line
- Actuator System Line

Soluzioni lineari per applicazioni medicali
Linear solutions for medical applications

ROLLON
BY TIMKEN

- Linear Line
- Telescopic Line
- Actuator Line
- Actuator System Line

Soluzioni lineari per interni ed architettura
Linear solutions for interiors and architecture







● Rollon Branches & Rep. Offices ● Distributors

EUROPE

ROLLON S.p.A. - ITALY (Headquarters)

Via Trieste 26
I-20871 Vimercate (MB)
Phone: (+39) 039 62 59 1
www.rollon.it - infocom@rollon.it

ROLLON GmbH - GERMANY

Bonner Strasse 317-319
D-40589 Düsseldorf
Phone: (+49) 211 95 747 0
www.rollon.de - info@rollon.de

ROLLON S.A.R.L. - FRANCE

Les Jardins d'Eole, 2 allée des Séquoias
F-69760 Limonest
Phone: (+33) (0) 4 74 71 93 30
www.rollon.fr - infocom@rollon.fr

ROLLON B.V. - NETHERLANDS

Ringbaan Zuid 8
6905 DB Zevenaar
Phone: (+31) 316 581 999
www.rollon.nl - info@rollon.nl

ROLLON S.p.A. - RUSSIA (Rep. Office)

117105, Moscow, Varshavskoye
shosse 17, building 1
Phone: +7 (495) 508-10-70
www.rollon.ru - info@rollon.ru

ROLLON Ltd - UK (Rep. Office)

The Works 6 West Street Olney
Buckinghamshire, United Kingdom, MK46 5 HR
Phone: +44 (0) 1234964024
www.rollon.uk.com - info@rollon.uk.com

AMERICA

ROLLON Corporation - USA

101 Bilby Road, Suite B
Hackettstown, NJ 07840
Phone: (+1) 973 300 5492
www.rolloncorp.com - info@rolloncorp.com

ROLLON - SOUTH AMERICA (Rep. Office)

R. Joaquim Floriano, 397, 2o. andar
Itaim Bibi - 04534-011, São Paulo, BRASIL
Phone: +55 (11) 3198 3645
www.rollonbrasil.com.br - info@rollonbrasil.com

ASIA

ROLLON Ltd - CHINA

No. 1155 Pang Jin Road,
China, Suzhou, 215200
Phone: +86 0512 6392 1625
www.rollon.cn.com - info@rollon.cn.com

ROLLON India Pvt. Ltd. - INDIA

1st floor, Regus Gem Business Centre, 26/1
Hosur Road, Bommanahalli, Bangalore 560068
Phone: (+91) 80 67027066
www.rollonindia.in - info@rollonindia.in

ROLLON - JAPAN

3F Shiodome Building, 1-2-20 Kaigan, Minato-ku,
Tokyo 105-0022 Japan
Phone +81 3 6721 8487
www.rollon.jp - info@rollon.jp